

# Loeblein Physics clicker questions

- Vector Addition 2-9
- Faraday Lab 10-17
- Forces & Motion 18-29
- Masses and Springs 30-38
- Waves on a string 39-56
- Energy Skate Park 57-91
- Projectile 92-102
- Sound 103-126
- Moving man 127-145
- Lady Bug Revolution 146-163
- Fourier 164-170
- Ramp-Force&Motion 171-177
- Geometric Optics 178-189
- Electric Field hockey & Charges and Fields 190-201
- Maze 202-206
- Pendulum 207-214
- Balloons and Buoyancy 215-227
- Ladybug Motion 2D 228-236
- Calculus Grapher 237-247
- Gas Properties and States of Matter 248-257
- Circuit Construction Kit 258-278
- Faraday Law- magnets and induction 279-286
- Gravity and Orbits 287-289
- Balloons/Static Electricity & Travoltage 290-298
- Wave Interference 299-307
- Resonance 308-313
- Under Pressure (Fluid Pressure Flow – Pressure tab) 314- 323
- Density 324-332
- Thanks to shared ideas 333

# Vector addition

Learning Goals: Students will be able to

- Explain vector representations in their own words
- Convert between the of angular form of vectors and the component form

Add vectors.

Trish Loeblein [phet.colorado.edu](http://phet.colorado.edu)

1. For one hour, you travel east in your car covering 100 km .Then travel south 100 km in 2 hours. You would tell your friends that your average speed was

*Start*

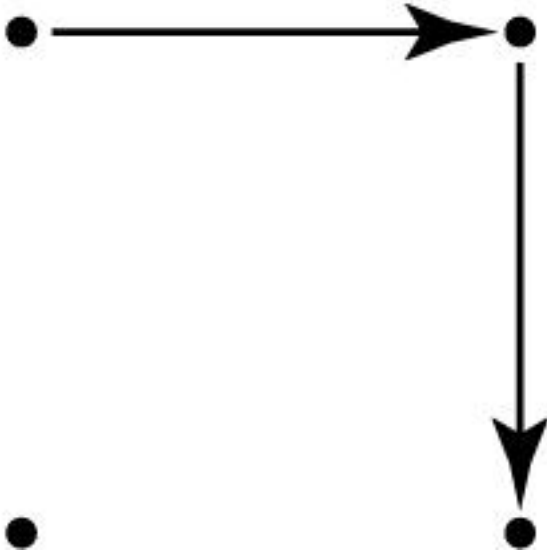

- A. 47 km/hr
- B. 67 km/hr
- C. 75 km/hr
- D. 141 km/hr
- E. 200 km/hr

2. For one hour, you travel east in your car covering 100 km .Then travel south 100 km in 2 hours. You would tell your friends that your average **velocity** was

**Start**

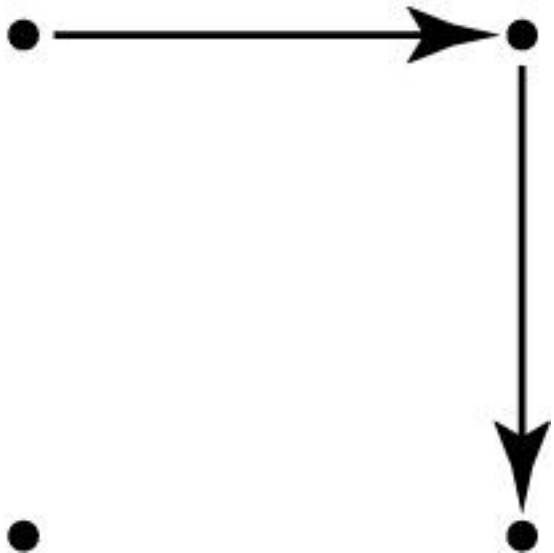

- A. 47 km/hr
- B. 67 km/hr
- C. 75 km/hr
- D. 141 km/hr
- E. 200 km/hr

3. You have already traveled east in your car 100 km in 1 hr and then south 100 km in 2 hrs. To get back home, you then drive west 100 km for 3 hours and then go north 100 km in 4 hours. You would say your average **velocity** for the total trip was

*Start*

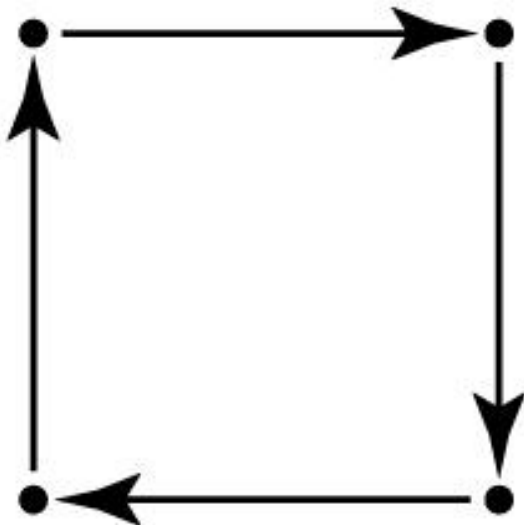

A. 20 km/hr

B. 40 km/hr

C. 60 km/hr

D. 100 km/hr

E. None of the above

4. You fly east in an airplane for 100 km. You then turn left 60 degrees and travel 200 km. How far **east** of the starting point are you? (approximately)

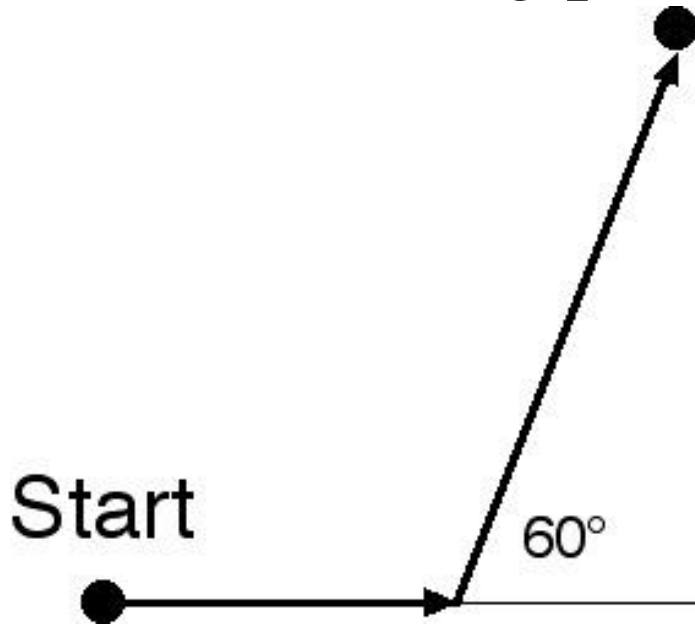

A. 100 km

B. 150 km

C. 200 km

D. 300 km

E. none of the above

5. You fly east in an airplane for 100 km. You then turn left 60 degrees and fly 200 km. How far **north** of the starting point are you? (approximately)

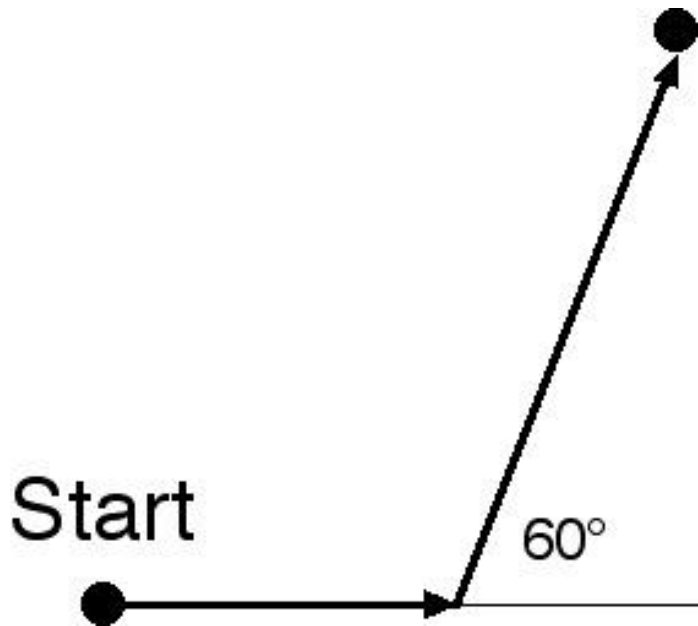

A. 100 km

B. 130 km

C. 170 km

D. 200 km

E. none of the above

6. You fly east in an airplane for 100 km. You then turn left 60 degrees and fly 200 km. How far **from** the starting point are you? (approximately)

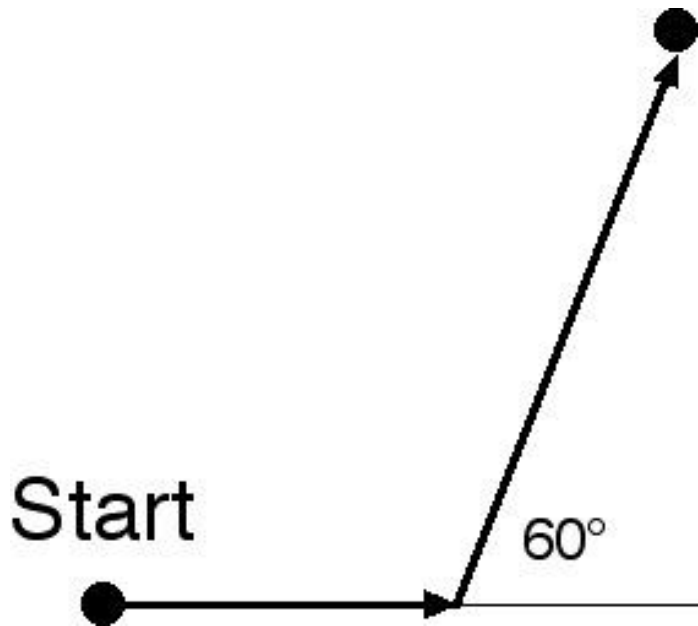

A. 170 km

B. 200 km

C. 260 km

D. 300 km

E. 370 km



7. You fly east in an airplane for 100 km. You then turn left 60 degrees and fly 200 km. In what **direction** are you from the starting point?

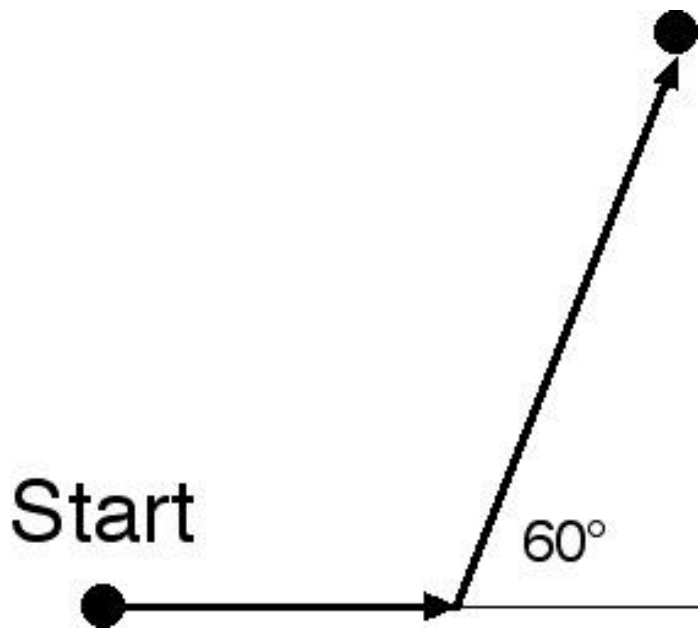

- A. South of west
- B. Directly southwest
- C. Directly northeast
- D. North of east
- E. None of the above

# Faraday Lab

Trish Loeblein [phet.colorado.edu](https://phet.colorado.edu)

## Learning Goals:

- Students will be able to:
- Identify equipment and conditions that produce induction
- Compare and contrast how both a light bulb and voltmeter can be used to show characteristics of the induced current
- Predict how the current will change when the conditions are varied.

Direction of induced current

A bar magnet is positioned below a horizontal loop of wire with its North pole pointing toward the loop. Then the magnet is pulled down, away from the loop. As viewed from above, is the induced current in the loop clockwise or counterclockwise?

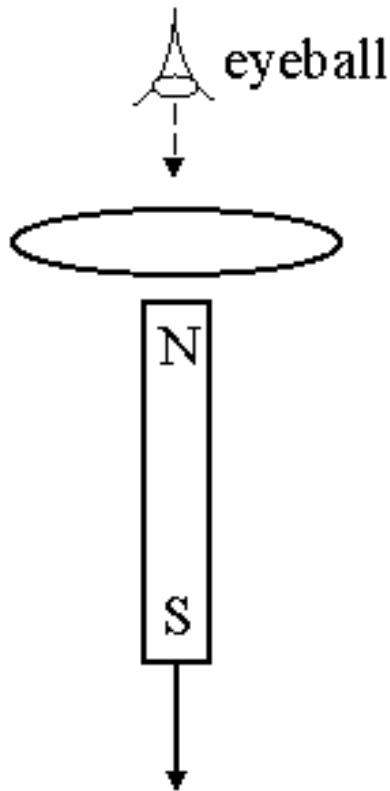

A) clockwise

B) counter-clockwise

Answer: The B-field from a bar magnet points out of the North pole. As seen from above, the field through the loop is out (toward the observer). As the magnet is pulled away, the flux is *decreasing*. To fight the decrease, the induced B-field should *add* to the original B-field, and also be out (toward the observer). The induced current will be (B), counterclockwise, in order to make an induced B-field out.

## Magnet

Two bar magnets are brought near each other as shown. The magnets...

A) attract

B) repel

C) exert no net force on each other.



# Cool image of magnetic fields on bar magnet

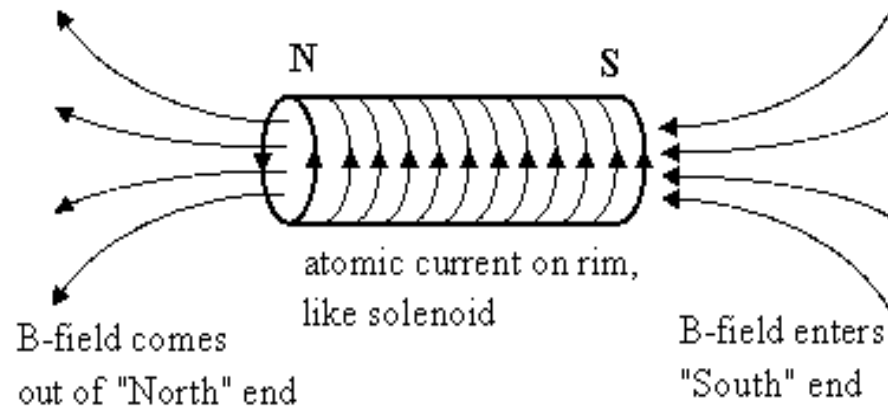

## Transformer

You have a transformer with  $N_p=6$  primary windings, and  $N_s=3$  secondary windings, as shown.

If  $V_p=120$  V AC, what is the current measured by the ammeter "A" in the secondary circuit?

- A) 120 A
- B) 60 A
- C) 240 A
- D) Nothing is measured because the fuse in the ammeter blows!

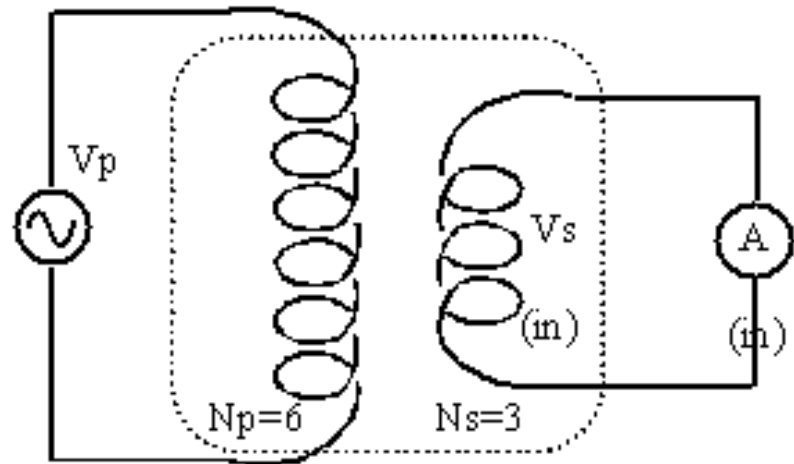

# Answer

The fuse in the ammeter blows! The secondary voltage is 60 VAC (it's a step-down transformer). The internal resistance of the ammeter is zero. So the ammeter current is  $I = V/R = 60 \text{ V}/(0 \text{ ohms}) = \text{infinite current}$ . The fuse will blow.



A solenoid is constructed with  $N$  loops of wire tightly wrapped around an iron-filled center. Due to budget cuts, the current that ordinarily runs through this solenoid is cut in half. As a result, the inductance of the solenoid is

- A. unchanged.
- B. quartered.
- C. halved.
- D. doubled.
- E. quadrupled.

# Clicker questions for Forces & Motion Activity 1

Trish Loeblein [phet.colorado.edu](http://phet.colorado.edu)

- Learning Goals: Students will be able to
- Predict, qualitatively, how an external force will affect the speed and direction of an object's motion
- Explain the effects with the help of a free body diagram
- Explain the difference between static friction, kinetic friction and friction force. *This goal is not addressed in the student directions, but is part of the post-lesson.*



Crate was moving to  
the right

Then, the guy  
pushed the crate

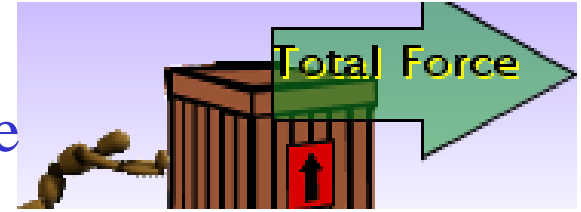

1. If the **total force** acts in the same direction as the crate is sliding, the crate

- A. slows down
- B. speeds up
- C. remains at same speed
- D. slows down, changes direction and then speeds up going the other way
- E. remains at same speed, but changes direction

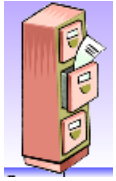

Cabinet was moving  
to the left

Then, the guy  
pushed the cabinet



2. If the **total force** acts in the opposite direction as the cabinet is sliding, the cabinet would
- A. slow down
  - B. speed up
  - C. remain at same speed
  - D. slow down, change direction and then speed up going the other way
  - E. remain at same speed, but change direction

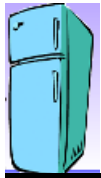

Refrigerator was moving to the right

Then, the guy pushed the refrigerator

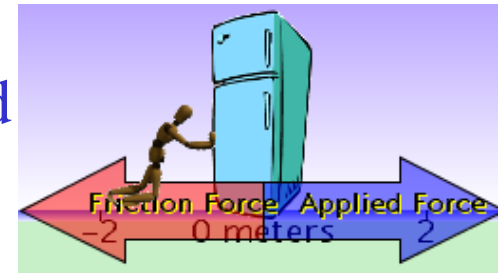

3. If there is **zero total force** acting on on the refrigerator, the refrigerator would
- A. slow down
  - B. speed up
  - C. remain at same speed
  - D. slow down, change direction and then speed up going the other way
  - E. remain at same speed, but change direction

# Clicker Questions for Forces & Motion Activity 2

Trish Loeblein [phet.colorado.edu](http://phet.colorado.edu)

## Learning Goals:

- Students will be able to:
- Use free body diagrams to draw position, velocity, acceleration and force graphs and vice versa
- Explain how the graphs relate to one another.
- Given a scenario or a graph, sketch all four graphs

1. A car is traveling along a road. Its acceleration is recorded as a function of time.



acceleration

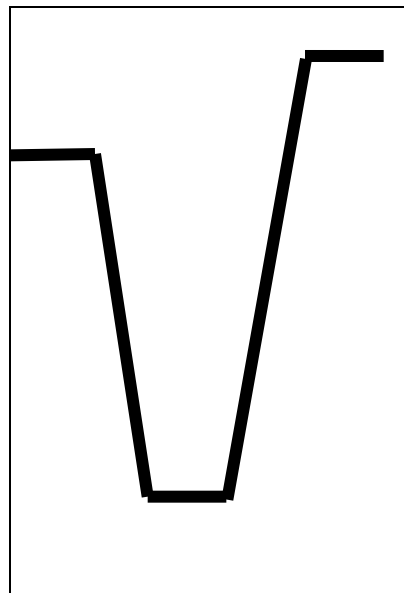

time

1. Which Total force-time graph would best match the scenario?

A

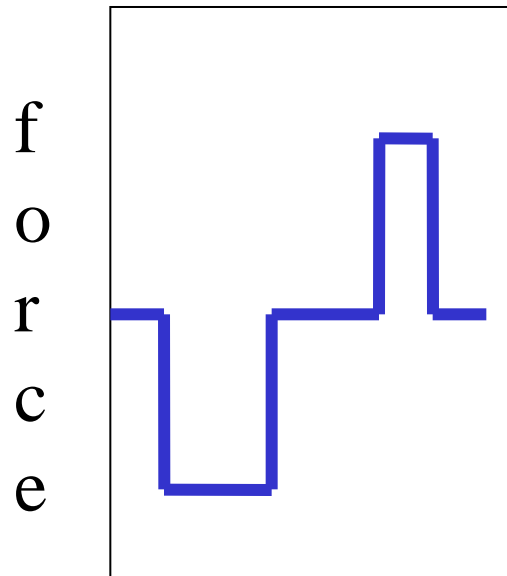

time

B

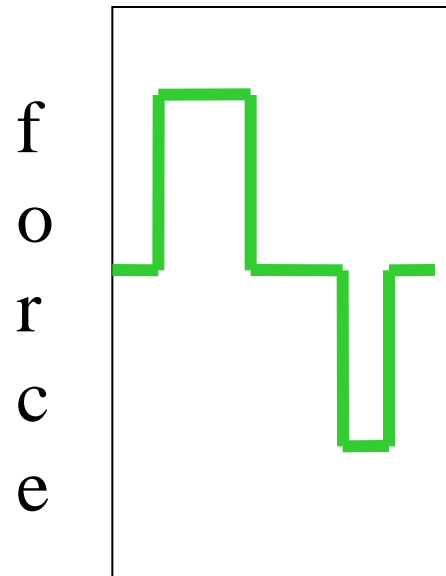

time

C

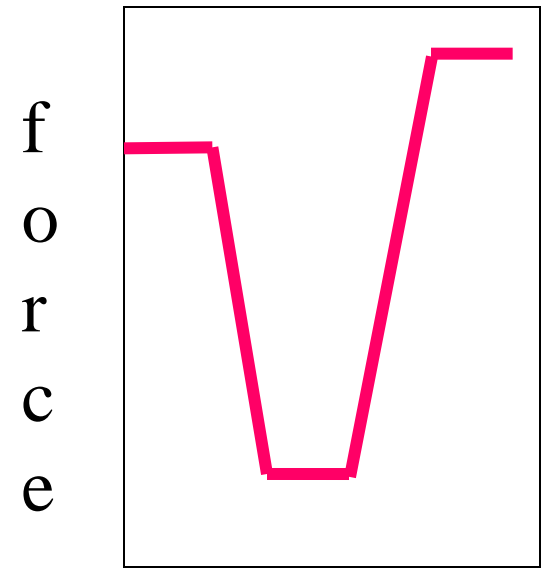

time



2. A cabinet is speeding up as it slides right across the room. Which of the following is a possible free body diagram?

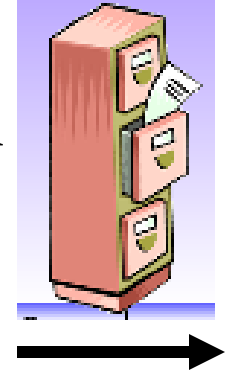

A

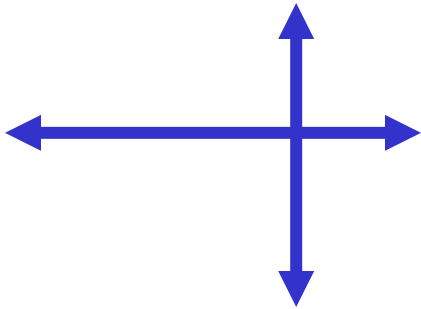

B

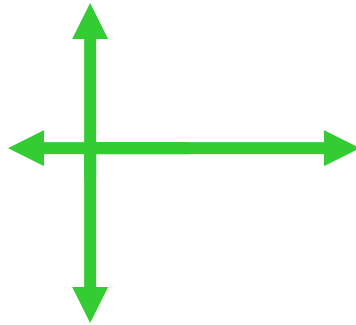

C

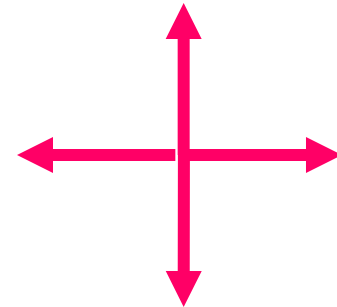

3. A car is traveling along a road. Its velocity is recorded as a function of time.

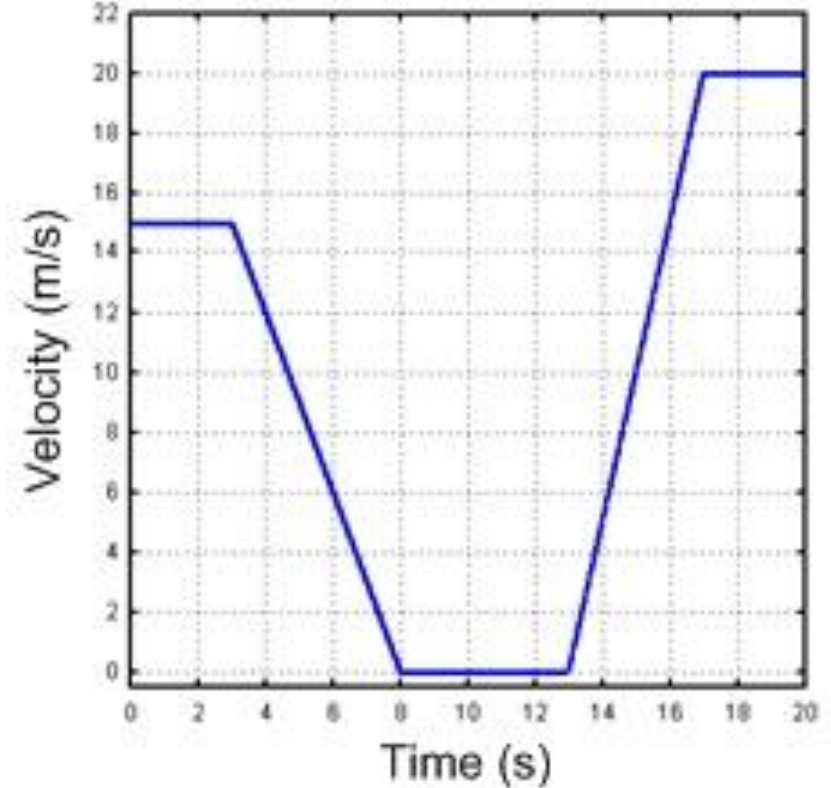

### 3. Which would be the **Total force-time** graph?

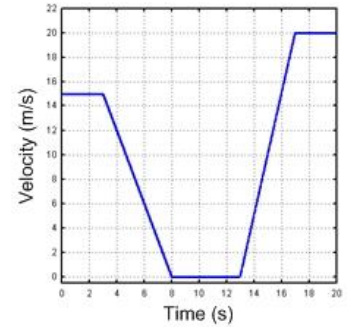

A

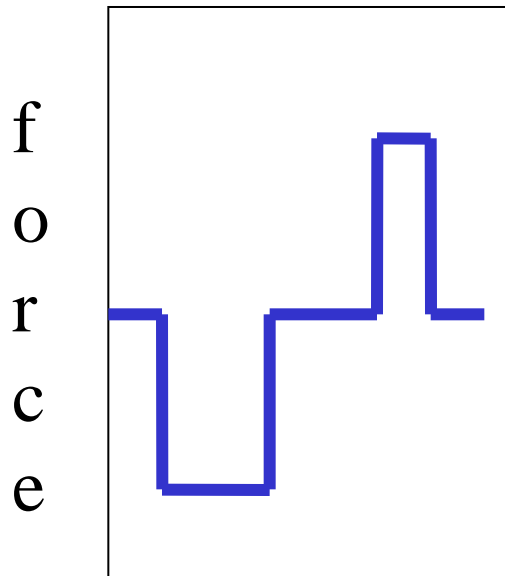

time

B

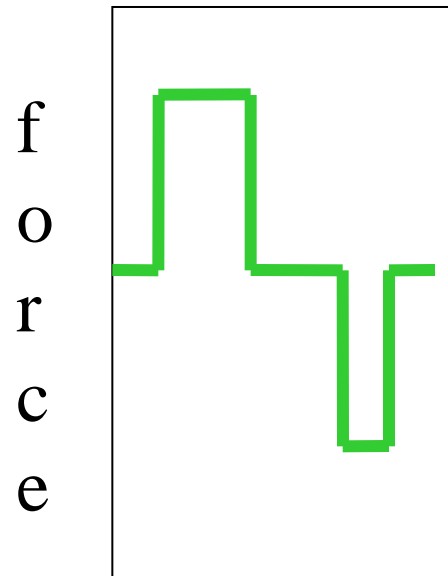

time

C

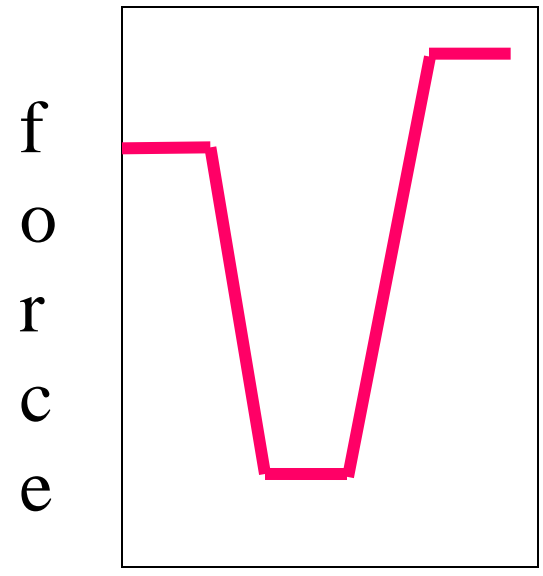

time

4. A car is moving towards the right. Then a force is applied and the free body diagram looks like this

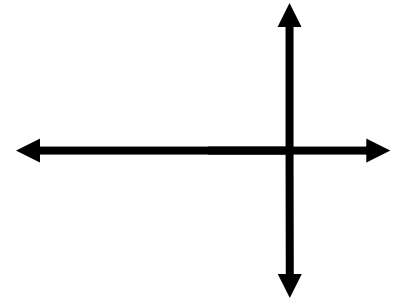

Force  
diagram

Draw what you think the *position-time* graph would look like.

4. Which *position-time* graph best matches your idea?

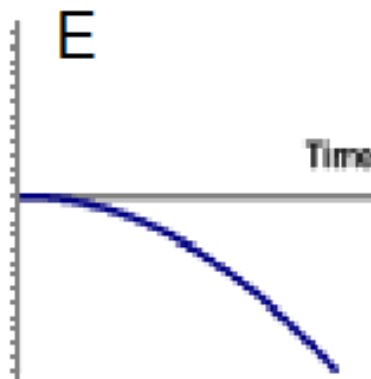
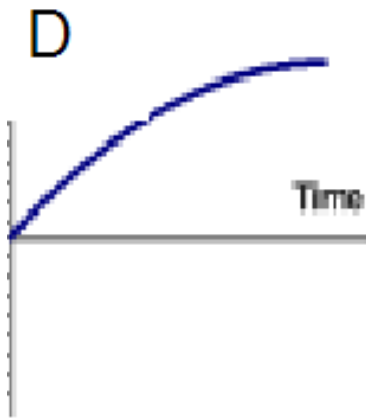
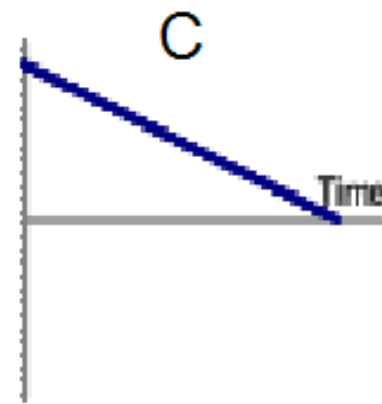
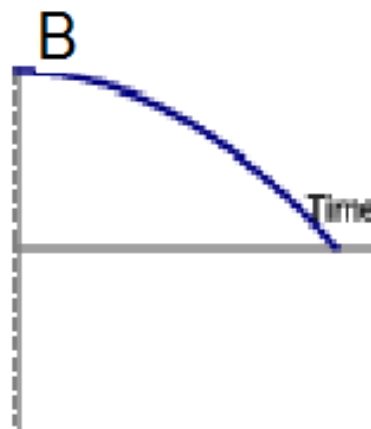
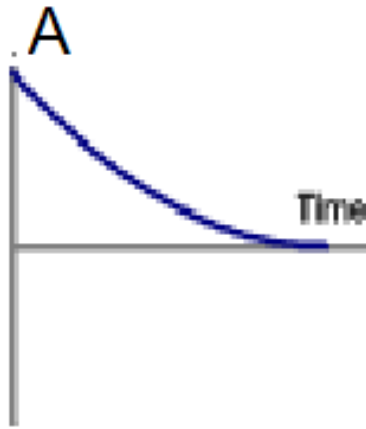
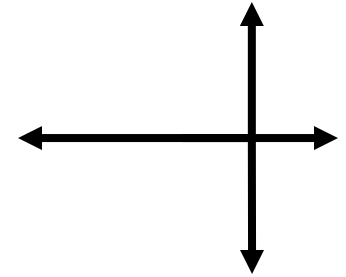

# Masses and Springs: Conservation of Energy

Learning Goals: Students will be able to explain the Conservation of Mechanical Energy concept using kinetic, elastic potential, and gravitational potential energy.

Trish Loeblein [phet.colorado.edu](https://phet.colorado.edu)

1. The main difference between kinetic energy,  $KE$ , and gravitational potential energy,  $PE_g$ , is that
  - A.  $KE$  depends on position and  $PE_g$  depends on motion
  - B.  $KE$  depends on motion and  $PE_g$  depends on position.
  - C. Although both energies depend on motion, only  $KE$  depends on position
  - D. Although both energies depend position, only  $PE_g$  depends on motion

2. Joe raised a box above the ground. If he lifts the same box twice as high, it has

- A. four times the potential energy
- B. twice the potential energy
- C. there is no change in potential energy.

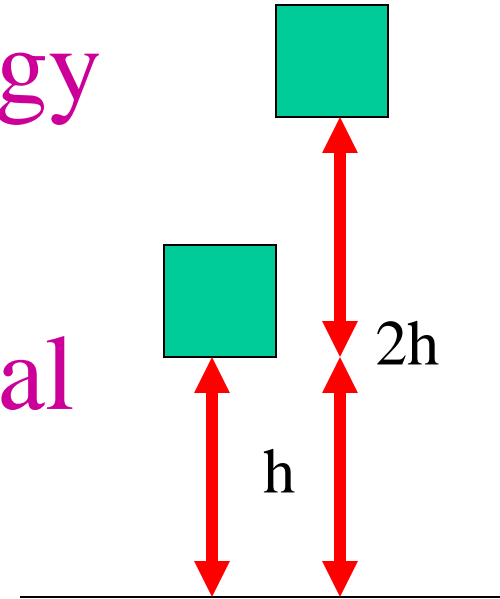



3. As any object free falls, the gravitational potential energy

A. vanishes

B. is immediately converted to kinetic energy

C. is converted into kinetic energy gradually until it reaches the ground

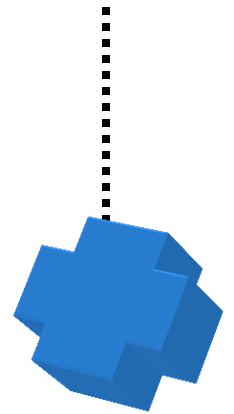

4. A small mass, starting at rest, slides **without friction** down a rail to a loop-de-loop as shown. Will the ball make it to the top of the loop?

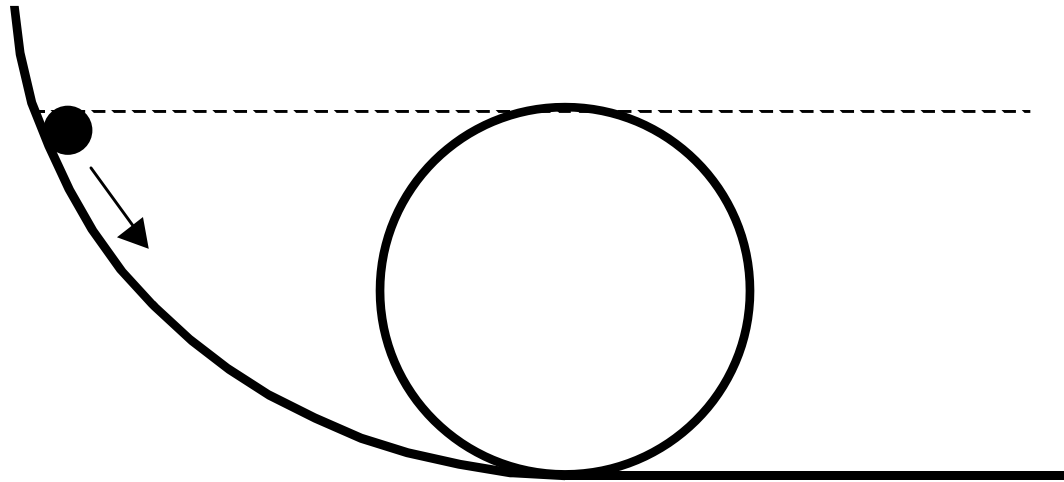

A. Yes

B. No

A spring is hanging from a fixed wire as in the first picture on the left. Then a mass is hung on the spring and allowed to oscillate freely (with no friction present). Answers A-D show different positions of the mass as it was oscillating.

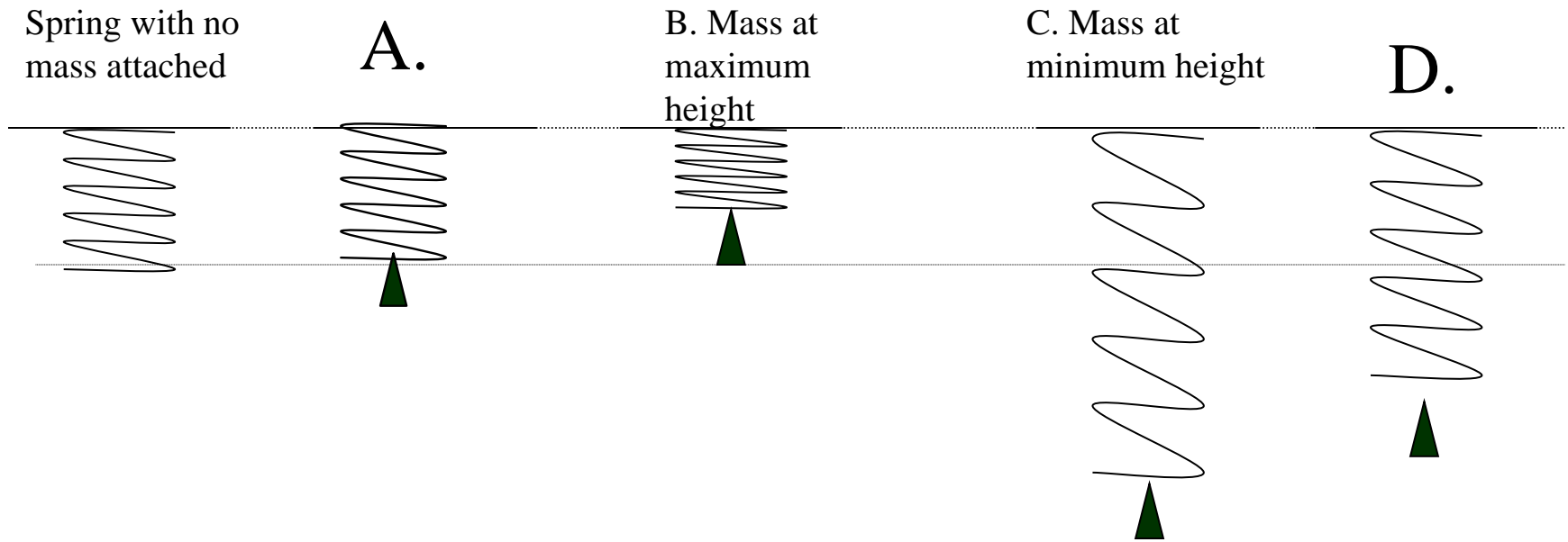

5. Where does the spring have maximum **elastic potential energy**?

A spring is hanging from a fixed wire as in the first picture on the left. Then a mass is hung on the spring and allowed to oscillate freely (with no friction present). Answers A-D show different positions of the mass as it was oscillating.

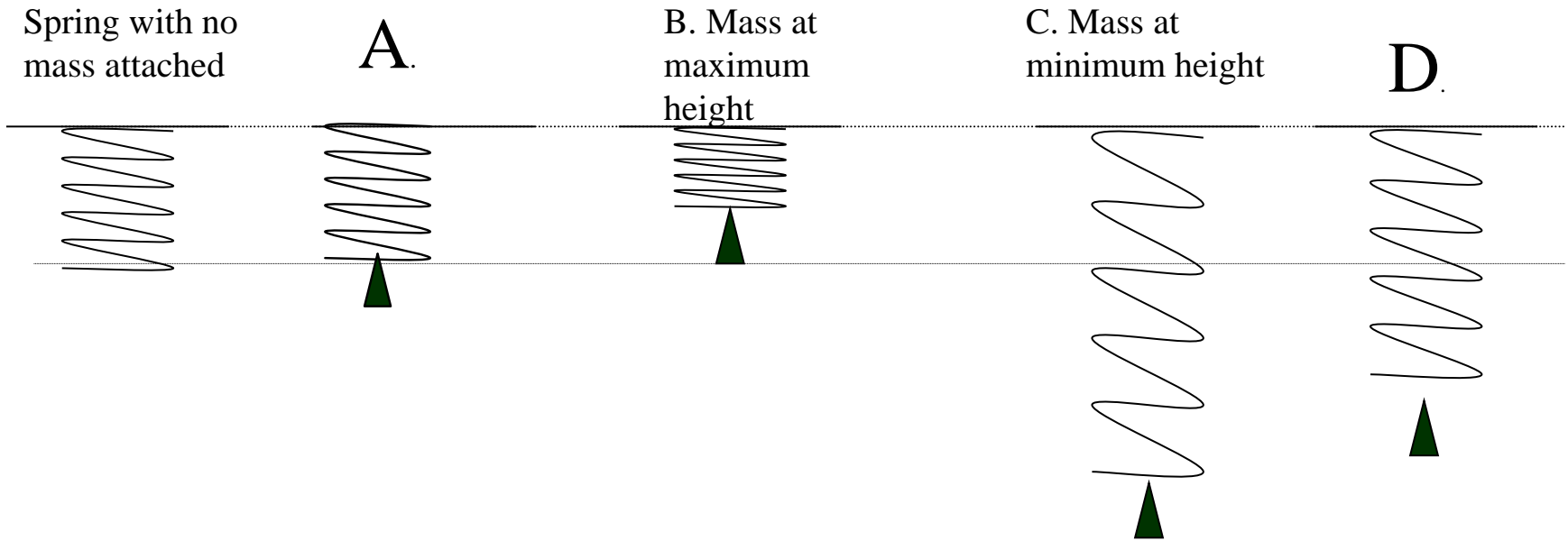

6. Where is the **gravitational potential energy** the least?

A spring is hanging from a fixed wire as in the first picture on the left. Then a mass is hung on the spring and allowed to oscillate freely (with no friction present). Answers A-D show different positions of the mass as it was oscillating.

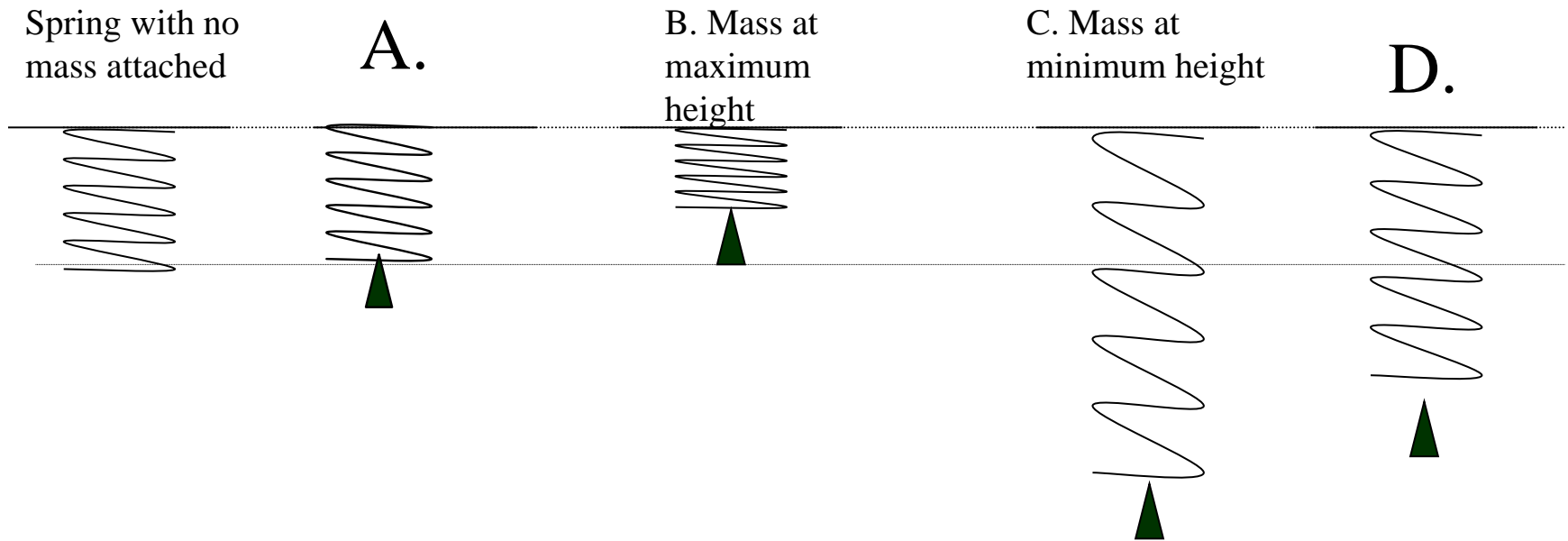

7. Where is the **kinetic energy** zero?

A spring is hanging from a fixed wire as in the first picture on the left. Then a mass is hung on the spring and allowed to oscillate freely (with no friction present). Answers A-D show different positions of the mass as it was oscillating.

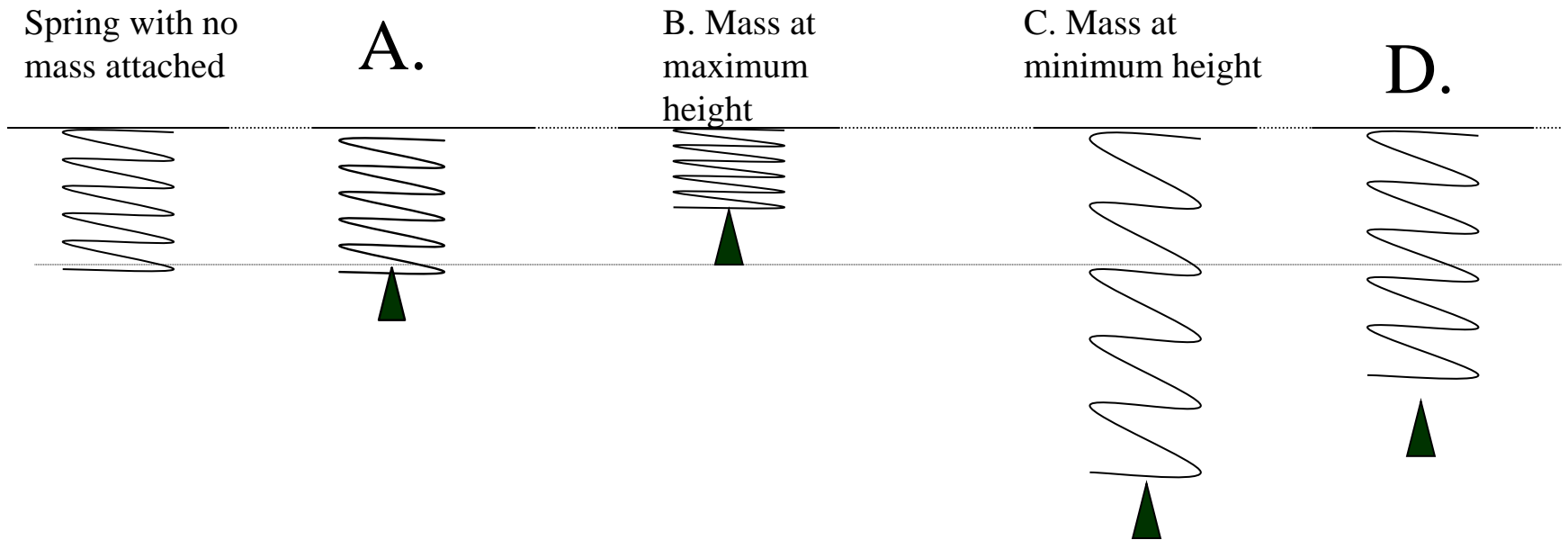

8. Where is the **elastic potential energy** zero?

# Waves on a String

Trish Loeblein [phet.colorado.edu](http://phet.colorado.edu)

**Learning Goals:** Students will be able to discuss wave properties using common vocabulary and they will be able to predict the behavior of waves through varying medium and at reflective endpoints.

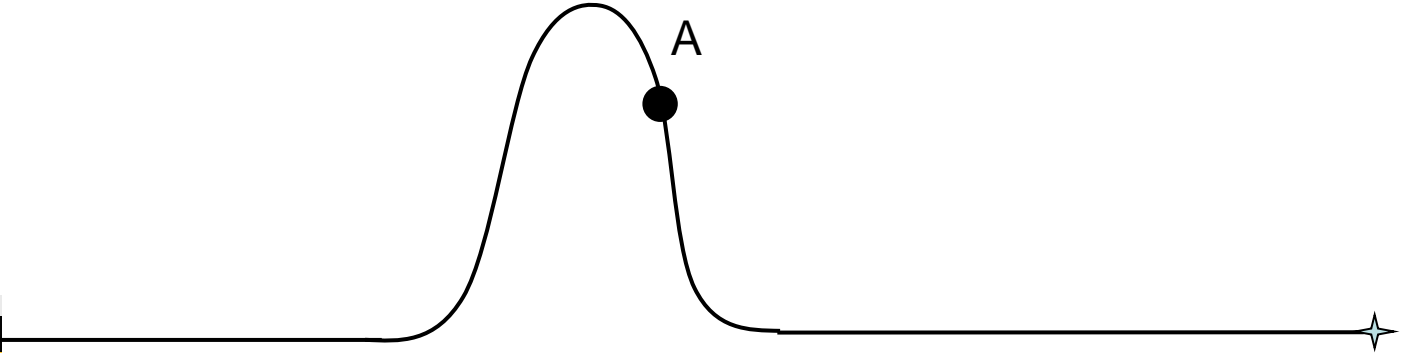
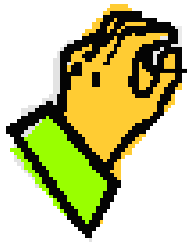

A



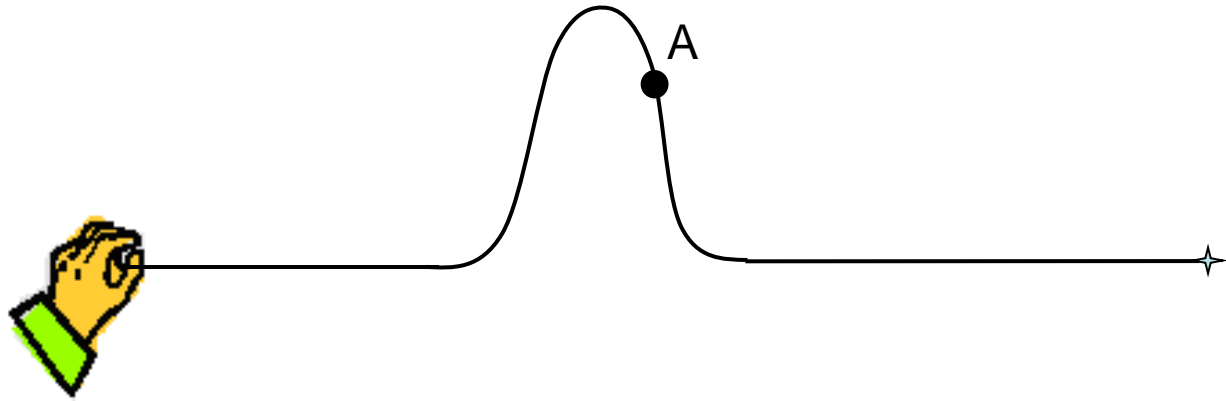

1. If you advance the movie one frame, the knot at point A would be
  - A. in the same place
  - B. higher
  - C. lower
  - D. to the right
  - E. to the left

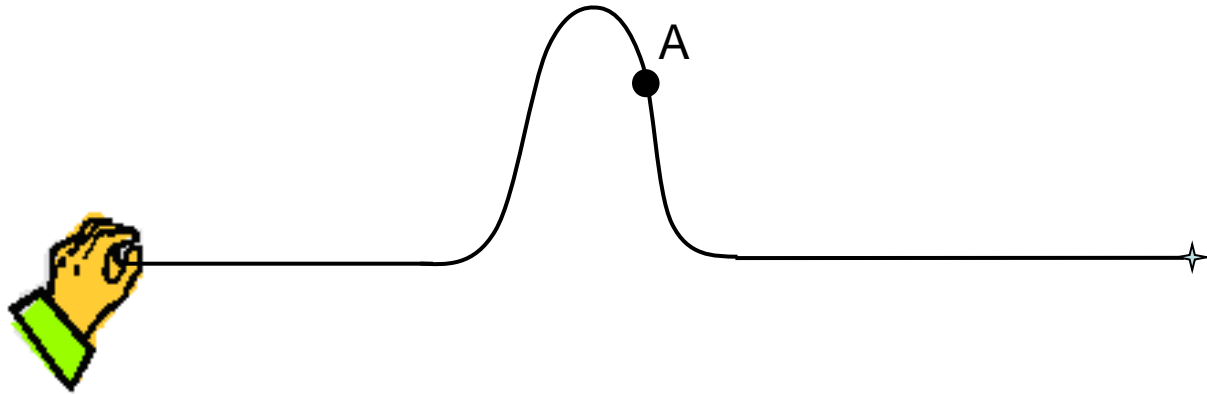

2. If the person generates a new pulse like the first but more quickly, the pulse would be
- A. same size
  - B. wider
  - C. narrower

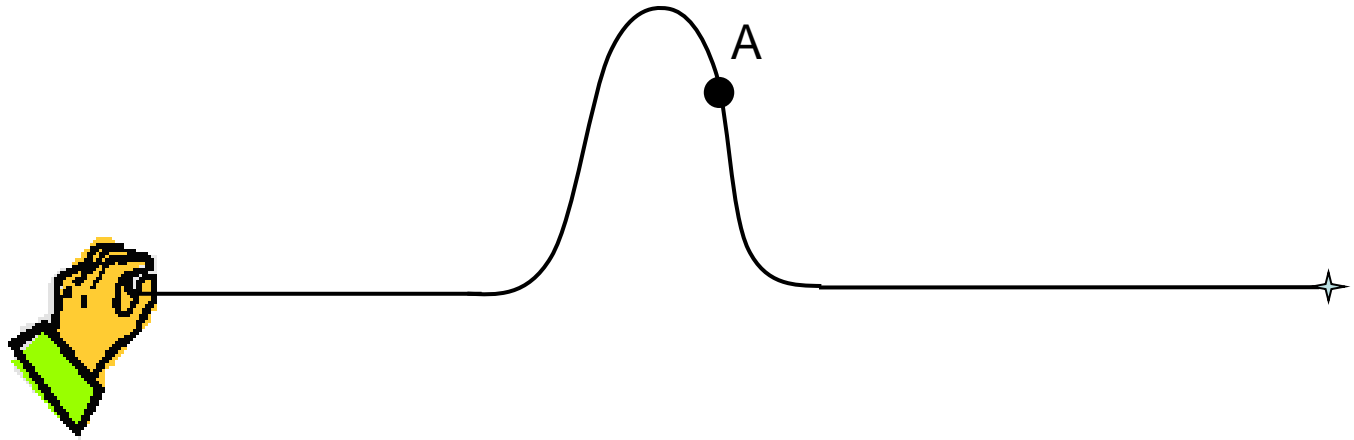

3. If the person generates another pulse like the first but he moves his hand further, the pulse would be
- A. same size
  - B. taller
  - C. shorter

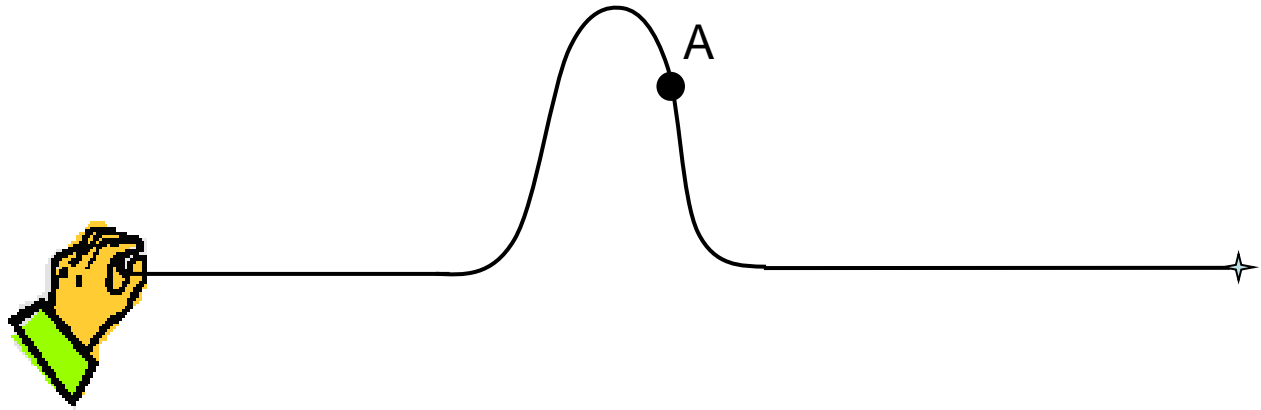

4. If the person generates another pulse like the first but the rope is tightened, the pulse will move
- A. at the same rate
  - B. faster
  - C. slower

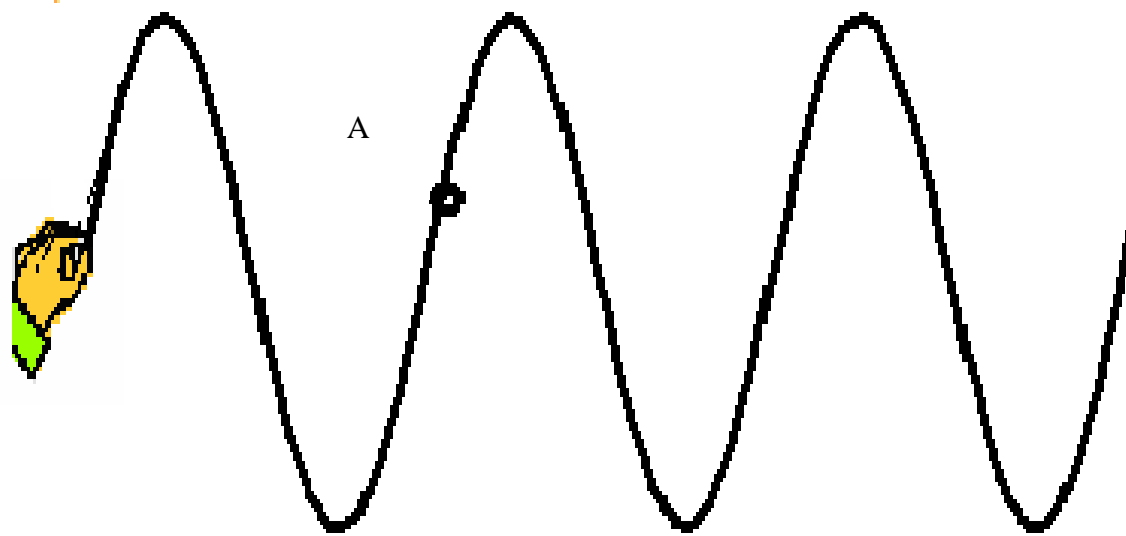

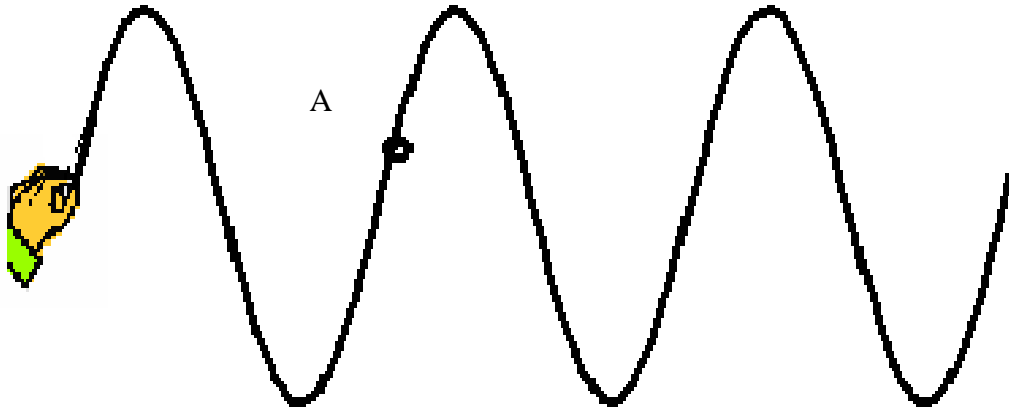

5. If you advance the movie one frame, the knot at point A would be
- A. in the same place
  - B. higher
  - C. lower
  - D. to the right
  - E. to the left



6. If you advance the movie one frame, the pattern of the waves will be \_\_\_\_\_ relative to the hand.

- A. in the same place
- B. shifted right
- C. shifted left
- D. shifted up
- E. shifted down

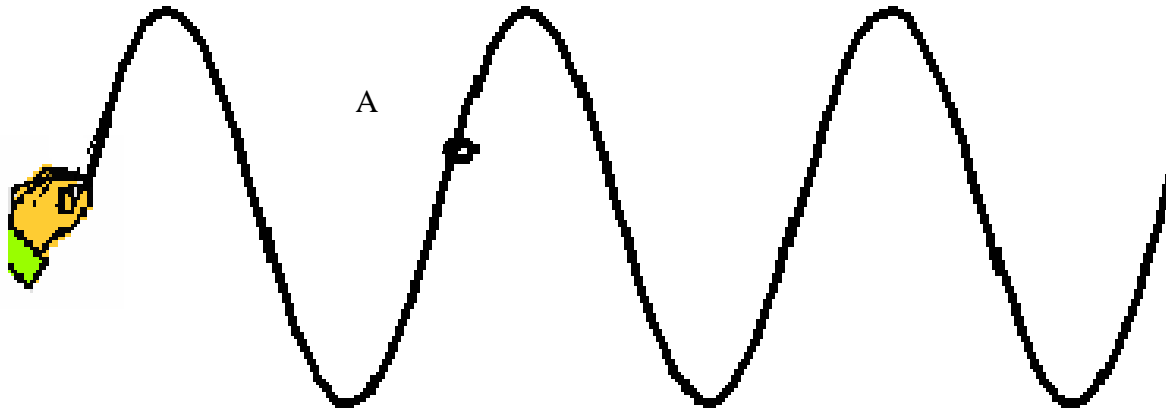

7. If the person starts over and moves his hand more quickly, the peaks of the waves will be
- A. the same distance apart
  - B. further apart
  - C. closer together



If you lower the frequency  
of a wave in a string you  
will

A. lower its speed.

B. increase its wavelength.

C. lower its amplitude.

D. shorten its period.

**CT-1.** At a particular instant of time, wave 1 and wave 2 are as shown. What does the sum of the two waves look like?  $f_{\text{total}} = f_1 + f_2$

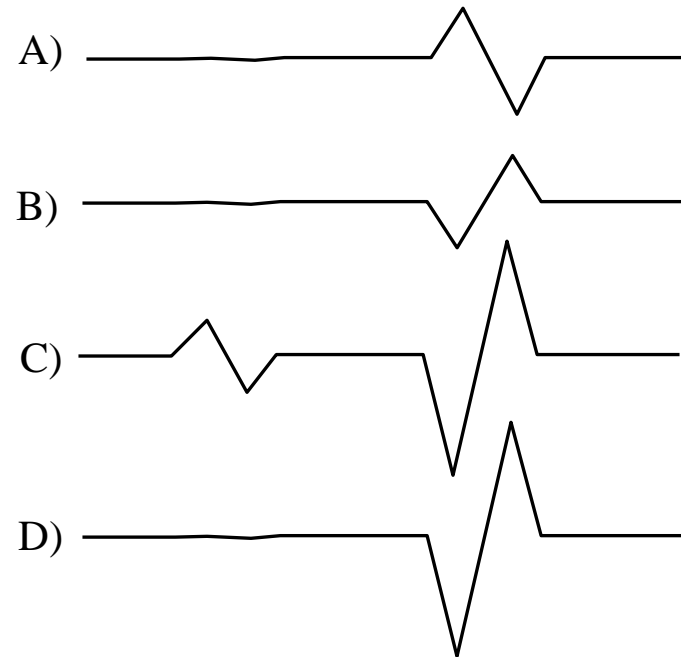
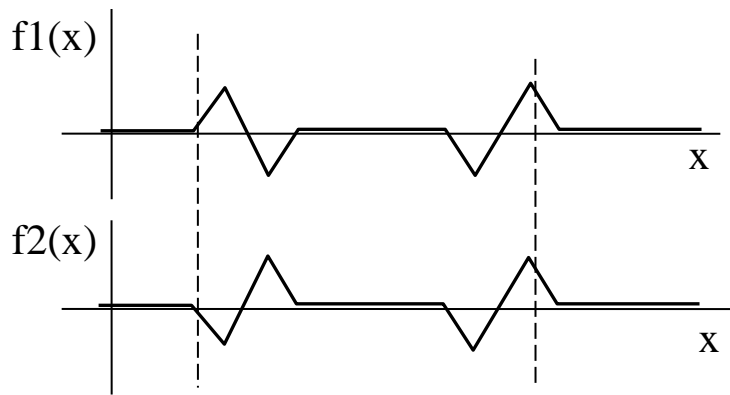

A string of beads are connected by a set of taut, massless springs. At the instant the clock starts ( $t=0$ ), a pulse is moving to the right on the beads and the shape looks like this.

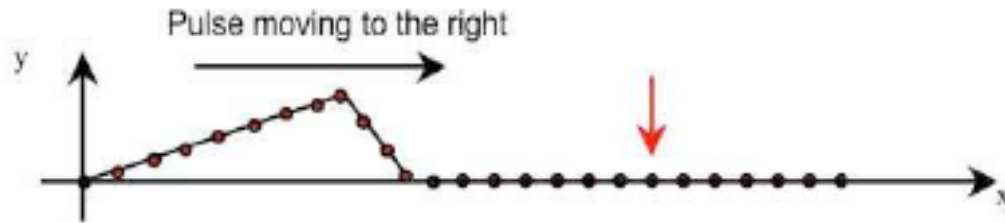

Which of the following graphs looks like a graph of the position for the bead marked with a red arrow as a function of time?

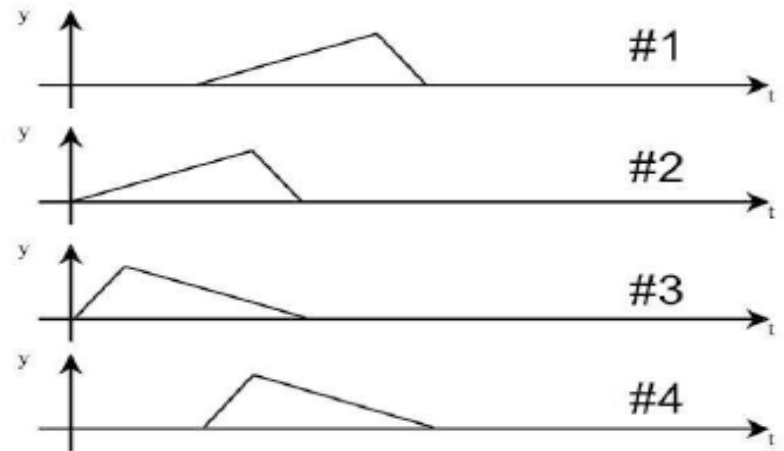

The pulse on the left is moving right, the pulse on the right is moving left. What do you see when the pulses overlap?

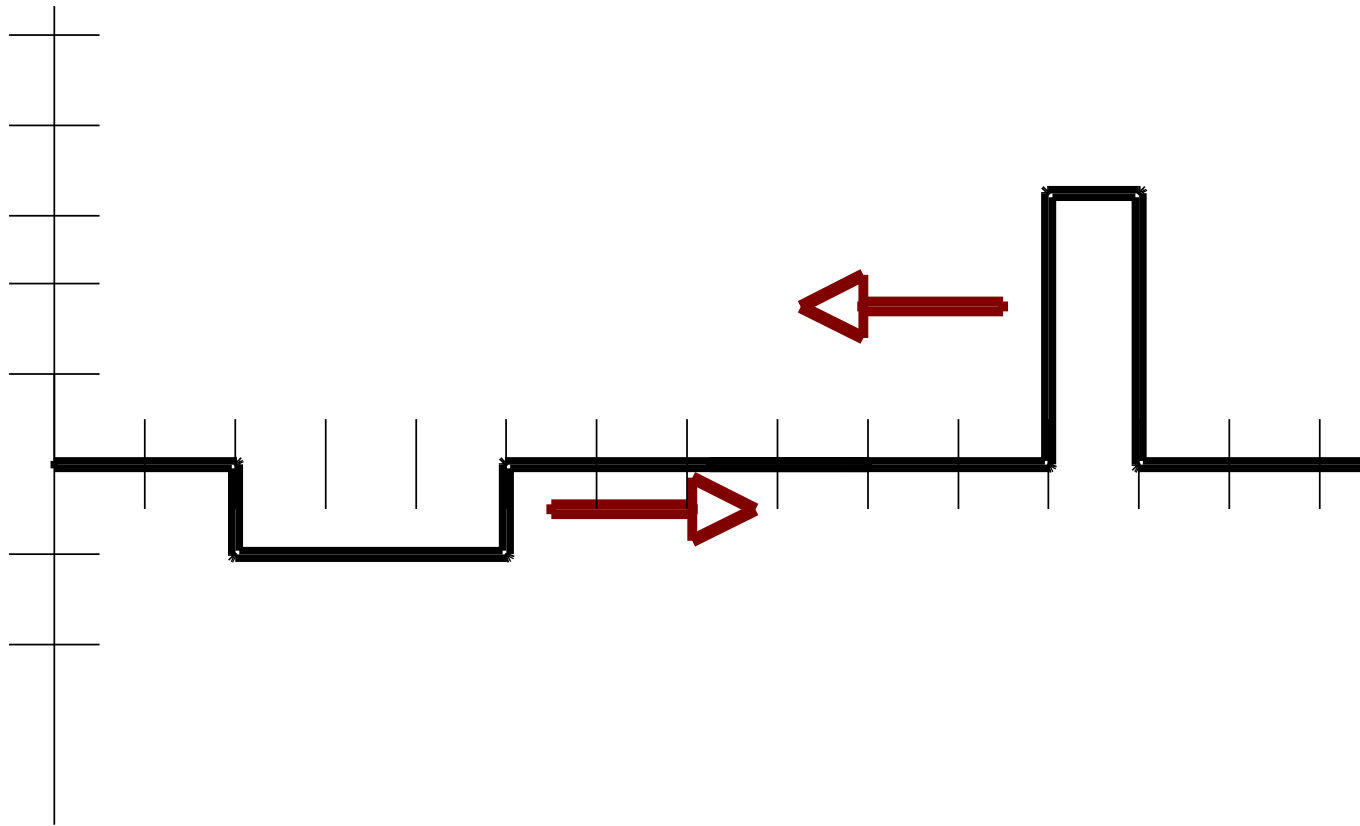

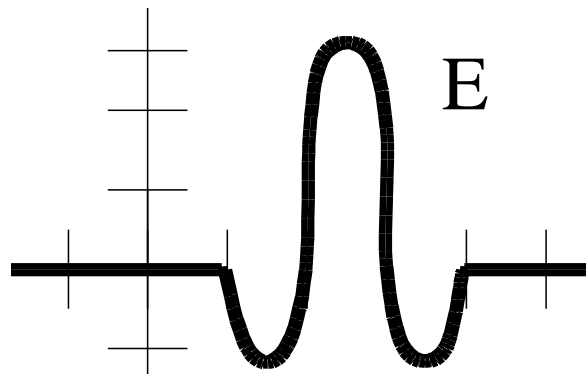
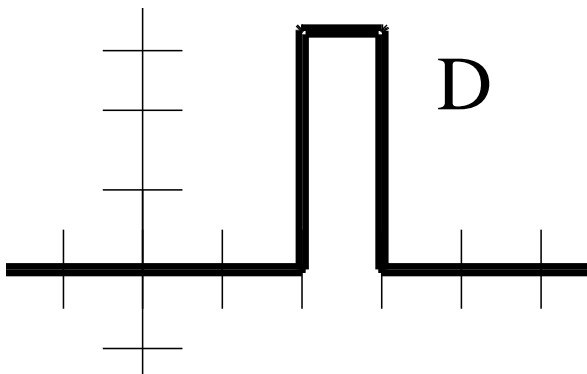
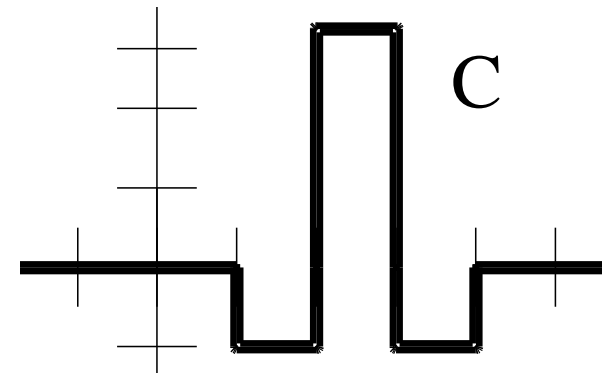
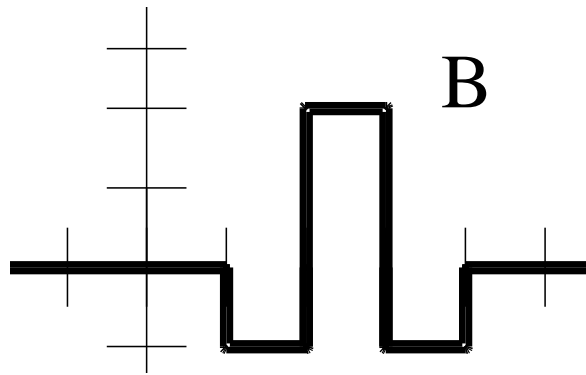
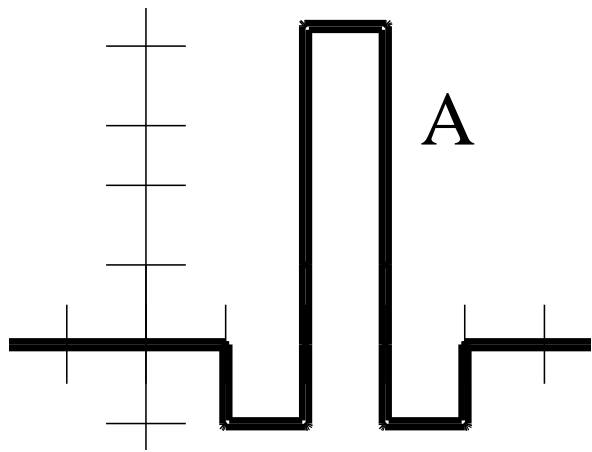
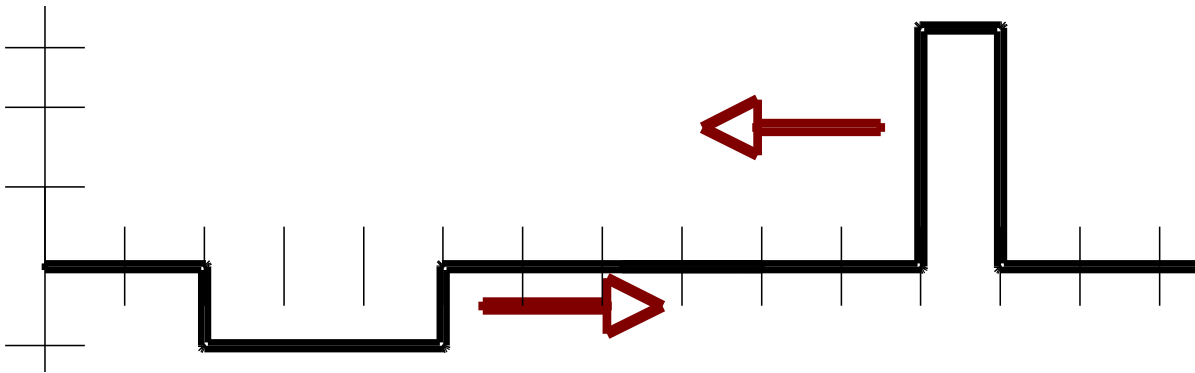

Rest of question

Adapted from CQ from Pollock University of Colorado

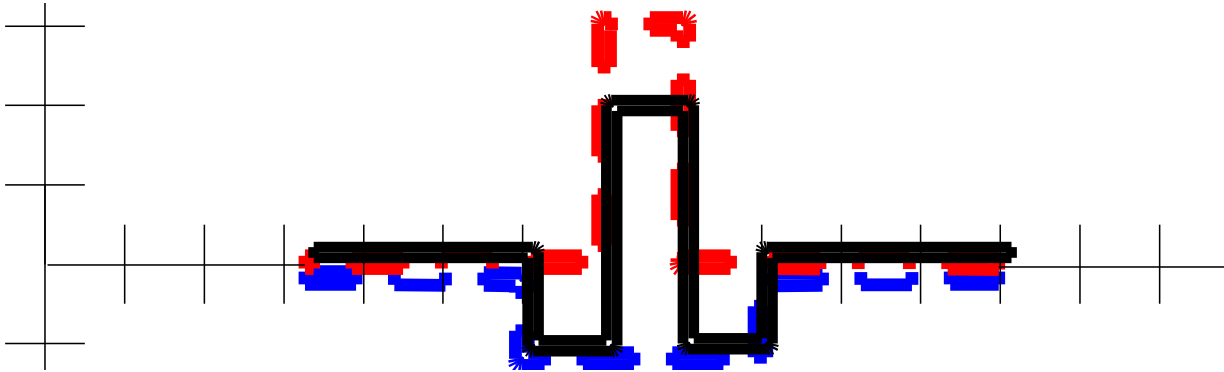
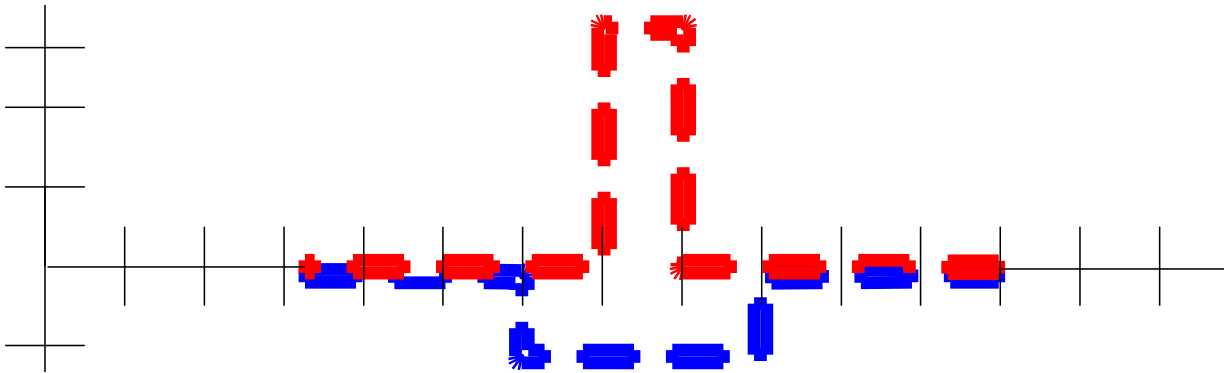
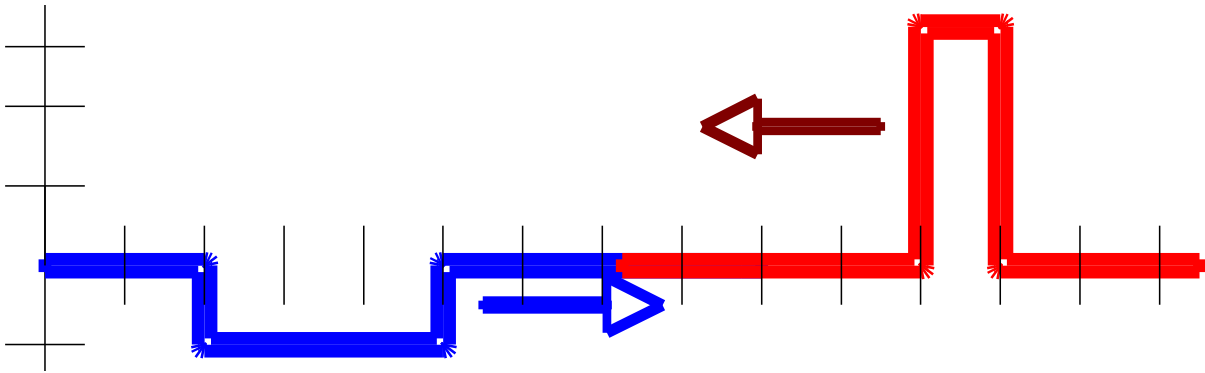

B

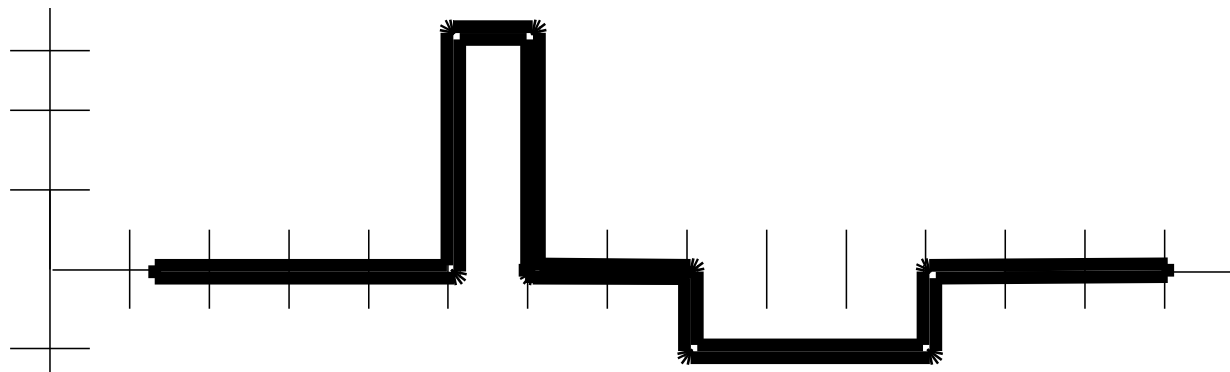
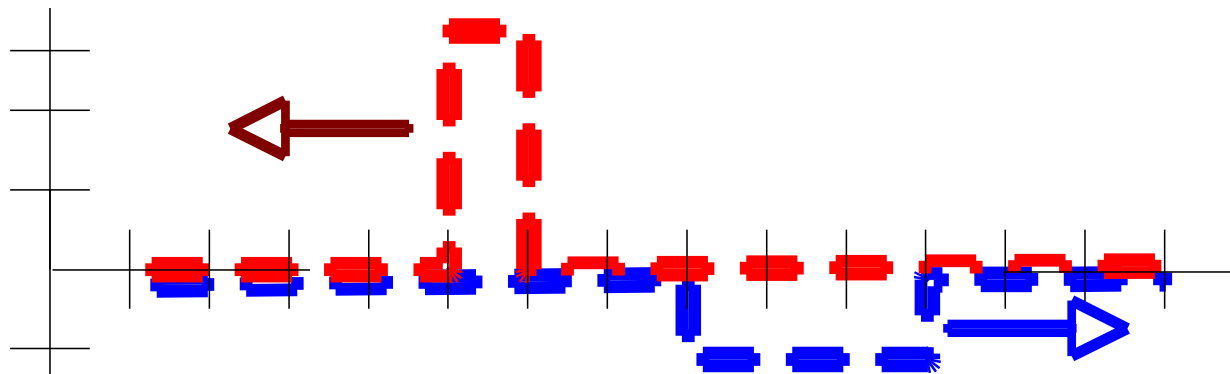
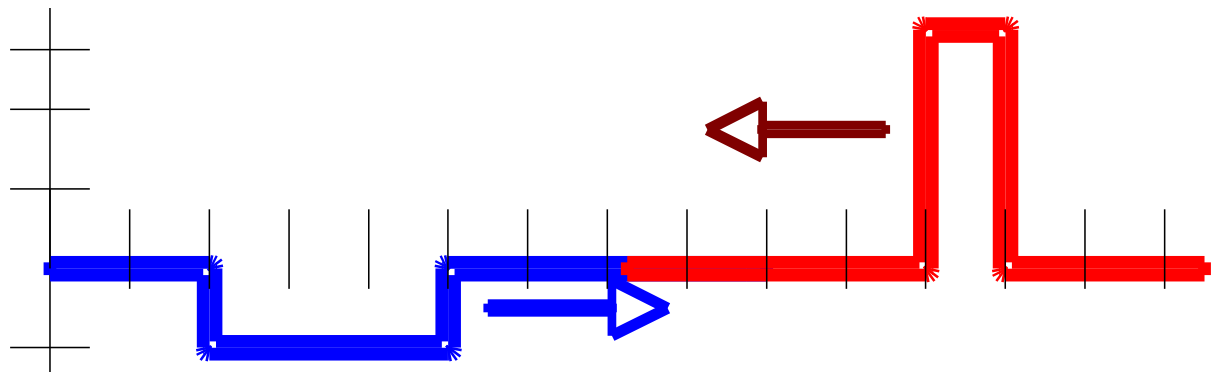

After interacting

Adapted from CQ from Pollock University of Colorado

A periodic wave is made to travel from a thick string into a thin string held at the same tension.

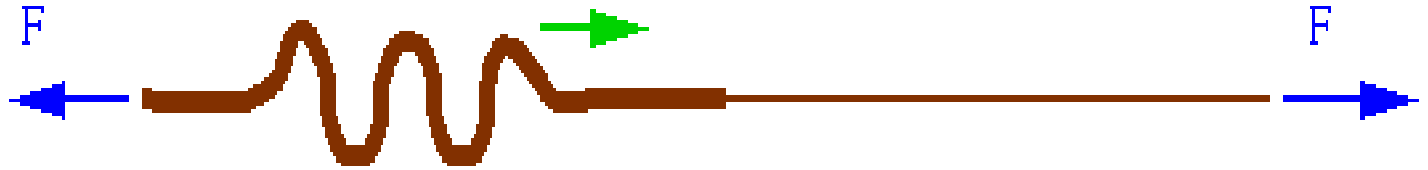

As the wave passes the join the wave's

- A. frequency increases.
- B. frequency decreases.
- C. wavelength increases.
- D. wavelength decreases.



# Skate Park activities 1-4

I have written a series of activities and here are the learning goals for all four. Each activity can be downloaded from the Teaching Ideas section of the PhET website.

## Activity 1: Introduction to Conservation of Mechanical Energy

- Explain the Conservation of Mechanical Energy concept using kinetic and gravitational potential energy.
- Design a skate park using the concept of Mechanical energy

## Activity 2: Relating Graphs, Position and Speed (no time graphs)

- Describe Energy -Position, -Bar, and -Pie Charts from position or selected speeds. *My thoughts about “selected” are zero, maximum, 1/2 max, etc*
- 1. Explain how changing the Skater affects the situations above. *The simulation treats all the objects the same (the same contact area and center of mass is one the track), so changing the type only changes the mass.*
- 2. Explain how changing the surface friction affects the situations above.
- Predict position or estimate of speed from Energy -Position, -Bar, and -Pie Charts
- Look at the position of an object and use the Energy -Position, -Bar, and -Pie charts to predict direction of travel or change in speed. *By “change in speed” I mean increasing or decreasing if for example the graph shows increasing PE, decreasing KE etc.*

## Activity 3: Calculating Speed and Height (no time graphs)

Students will be able to

- Calculate speed or height from information about a different position.
- Describe how different gravity fields effect the predictions.
- Describe how changing the PE reference effects the predictions. *I decided to leave this goal out of the students’ directions and either discuss it with the class or omit it.*

## Activity 4: Calculations with Conservation of Mechanical Energy using time graphs

Students will be able to use **Energy-Time** graphs to... at a given time.

- Estimate a location for the Skater on a track.
- Calculate the speed or height of the Skater
- Predict energy distribution for tracks with and without friction.

1. Do you think the Skater will make it over the first hump?

(No friction on the track)

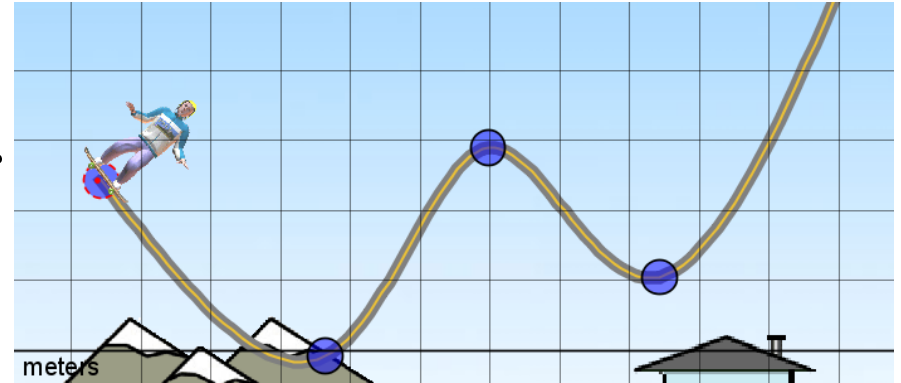

- A. No, because his potential energy will be converted to thermal energy
- B. No, because he doesn't have enough potential energy
- C. Yes, because all of his potential energy will be converted to kinetic energy
- D. Yes, because some of his energy will be potential and some kinetic

2. Do you think the Skater will make it over the first hump?

(lots of track friction)

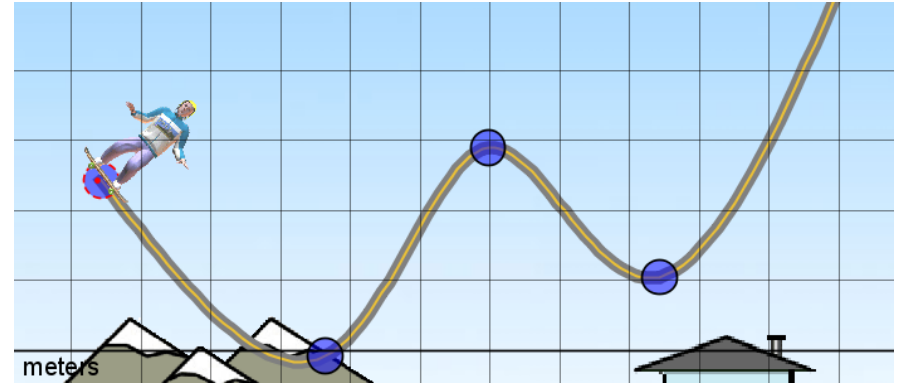

- A. No, because his potential energy will be converted to thermal energy
- B. No, because he doesn't have enough potential energy
- C. Yes, because all of his potential energy will be converted to kinetic energy
- D. Yes, because some of his energy will be potential and some kinetic

3. Do you think the Skater will make it over the first hump?

(No friction on the track)

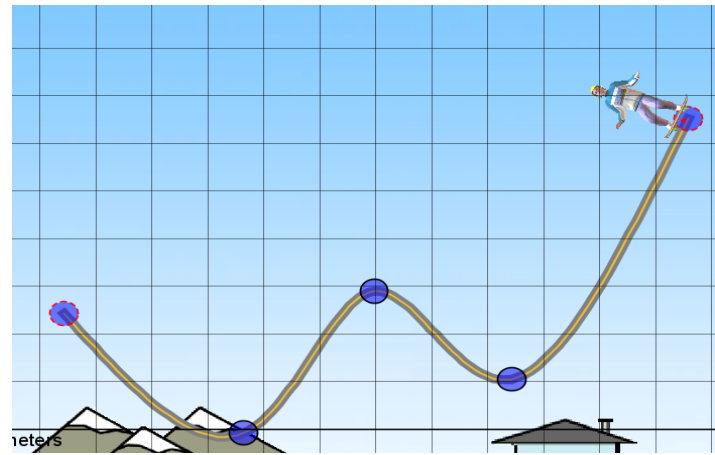

- A. No, because his potential energy will be converted to thermal energy
- B. No, because he doesn't have enough potential energy
- C. Yes, because all of his potential energy will be converted to kinetic energy
- D. Yes, because some of his energy will be potential and some kinetic

4. Do you think the Skater will make it over the first hump?  
(lots of track friction)

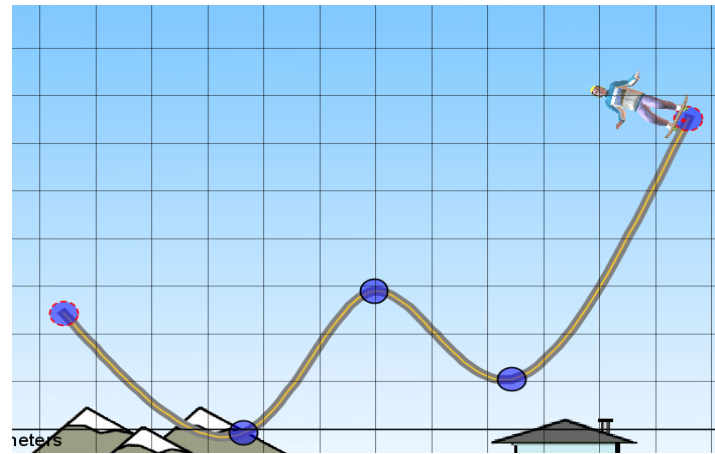

- A. No, because his potential energy will be converted to thermal energy
- B. Yes, if not too much energy is converted to thermal
- C. Yes, because all of his potential energy will be converted to kinetic energy
- D. Yes, because some of his energy will be potential and some kinetic

5. In the next moment, the **KE** piece of the pie gets larger, then

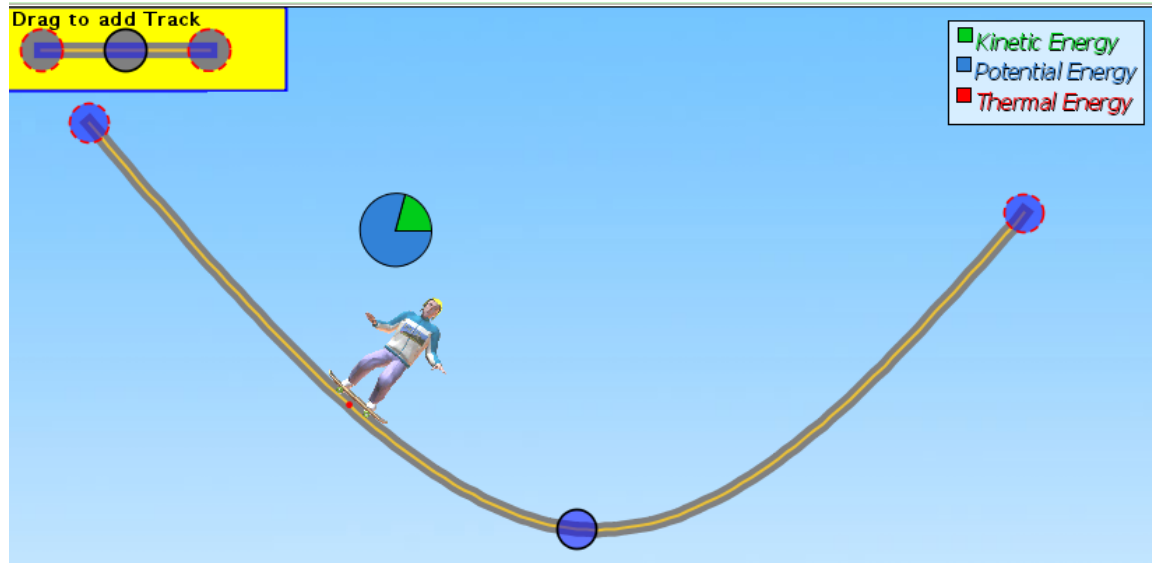

- A. The Skater is going up hill (left)
- B. The Skater is going down hill (right)
- C. There is no way to tell

6. In the next moment, the **KE** piece of the pie gets larger, then

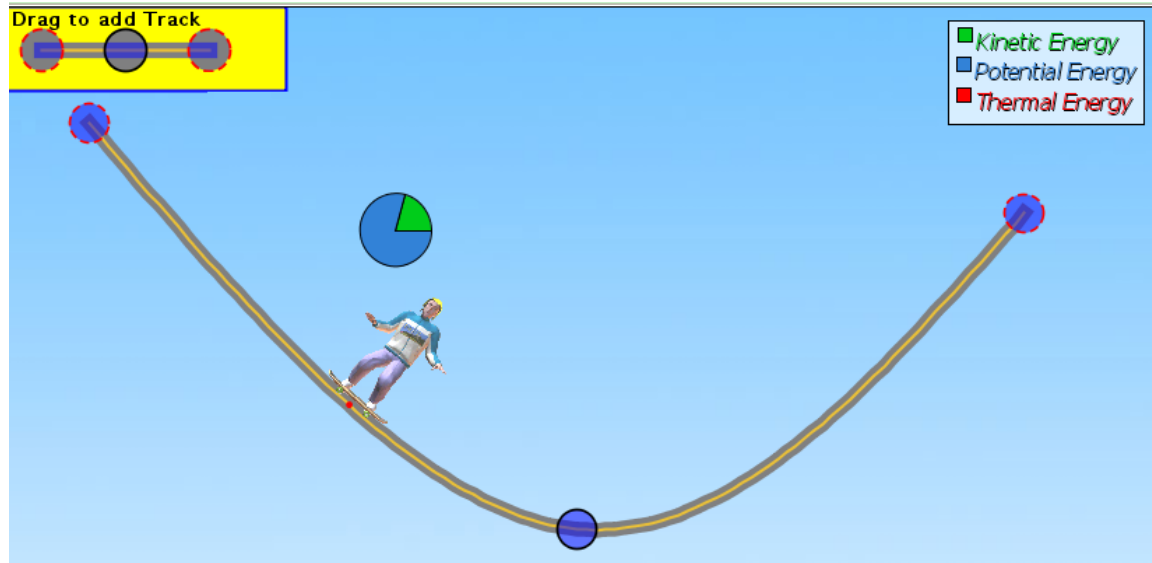

- A. The **PE** part stays the same
- B. The **PE** part gets larger too
- C. The **PE** part gets smaller
- D. There is no way to tell

7. In the next moment, the **KE** piece of the pie gets larger, then

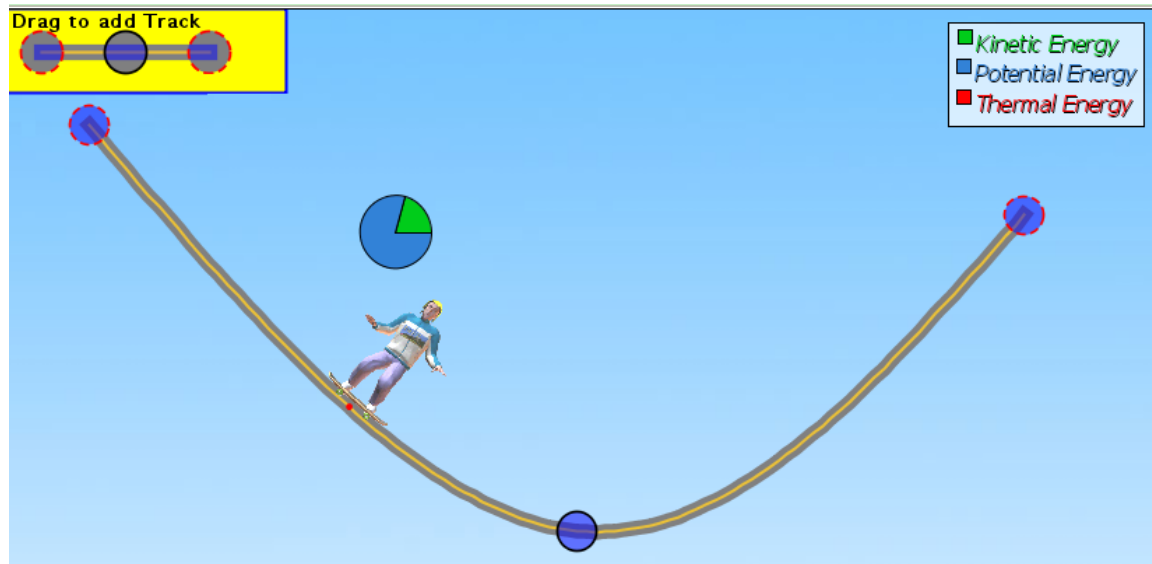

- A. The Skater will be going faster
- B. The Skater will be going slower
- C. There is no way to tell



1. The dotted line on the chart shows the energy of the Skater, where could she be on the track?

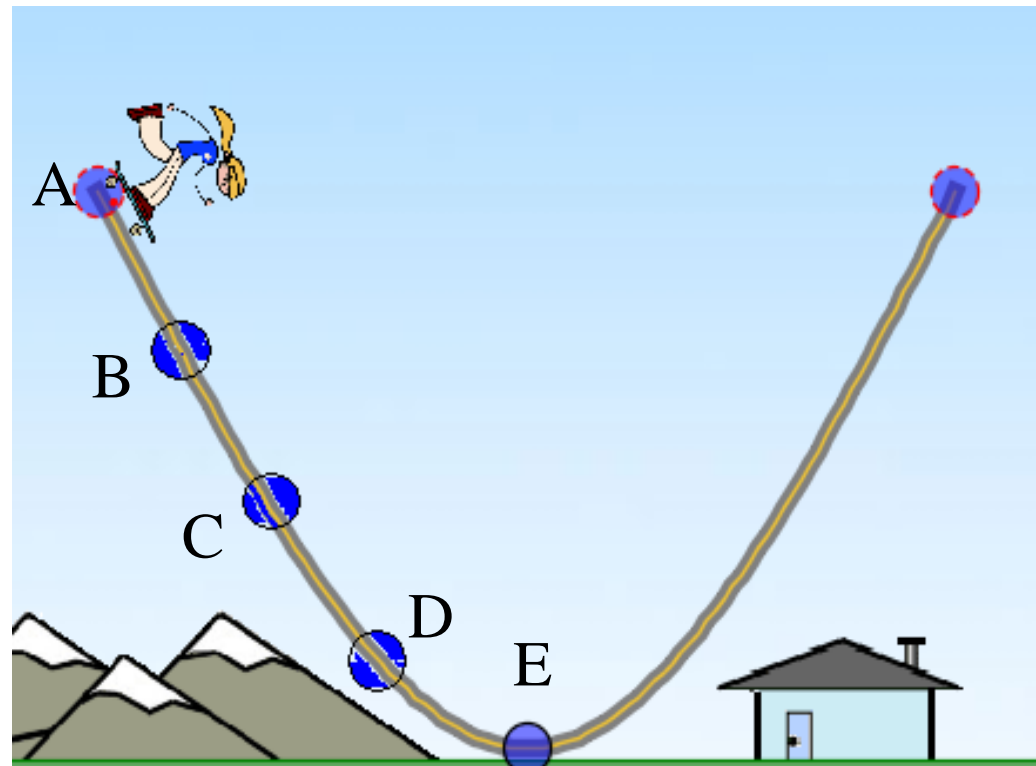
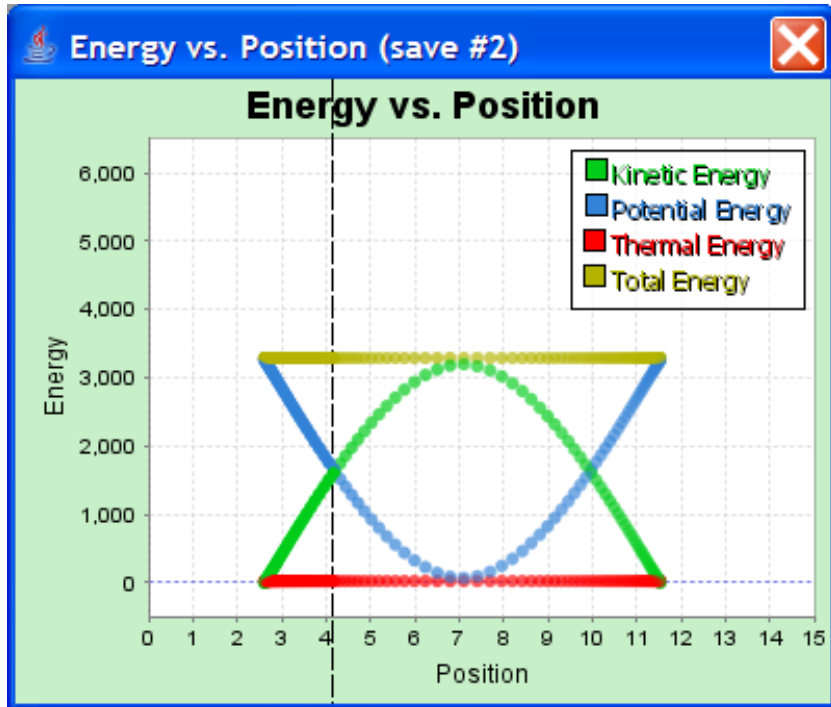

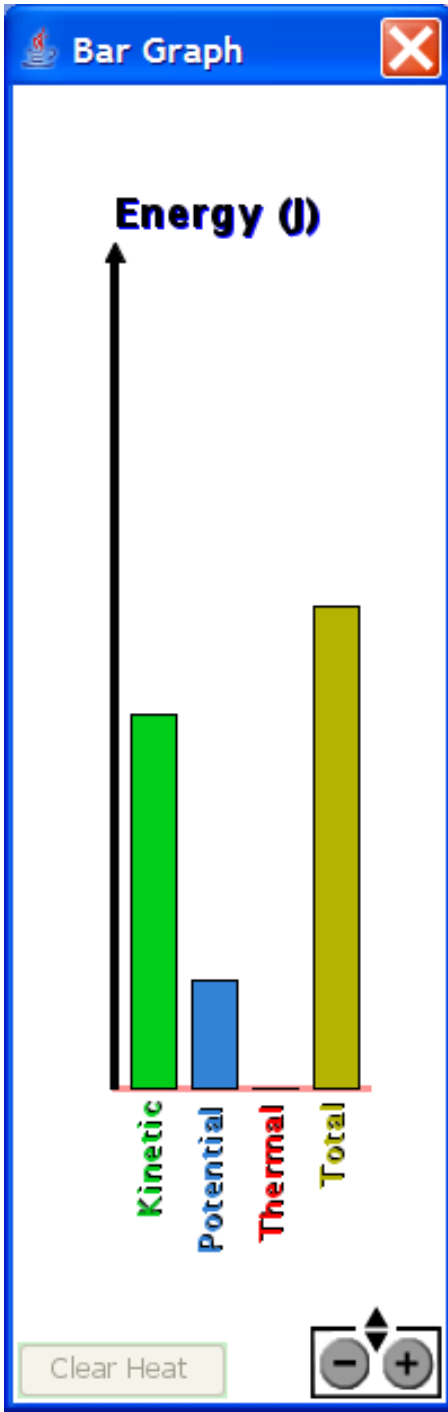

2. The bar graph shows the energy of the Skater, where could she be on the track?

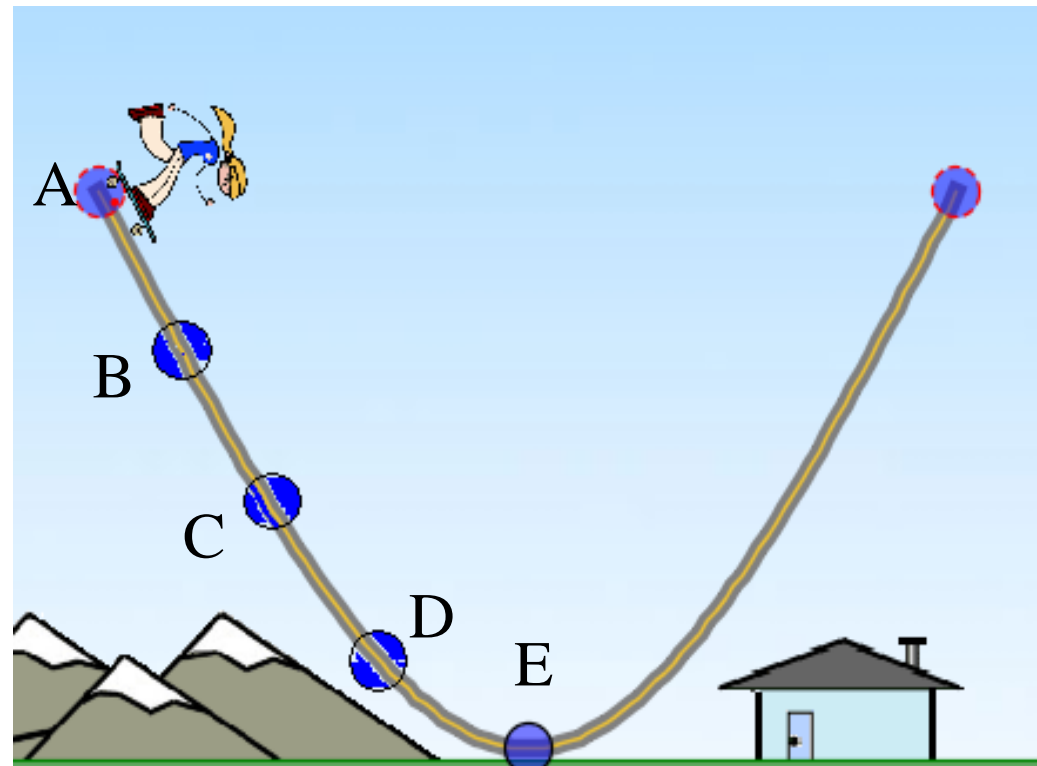

3. The pie graph shows the energy of the Skater, where could she be on the track?

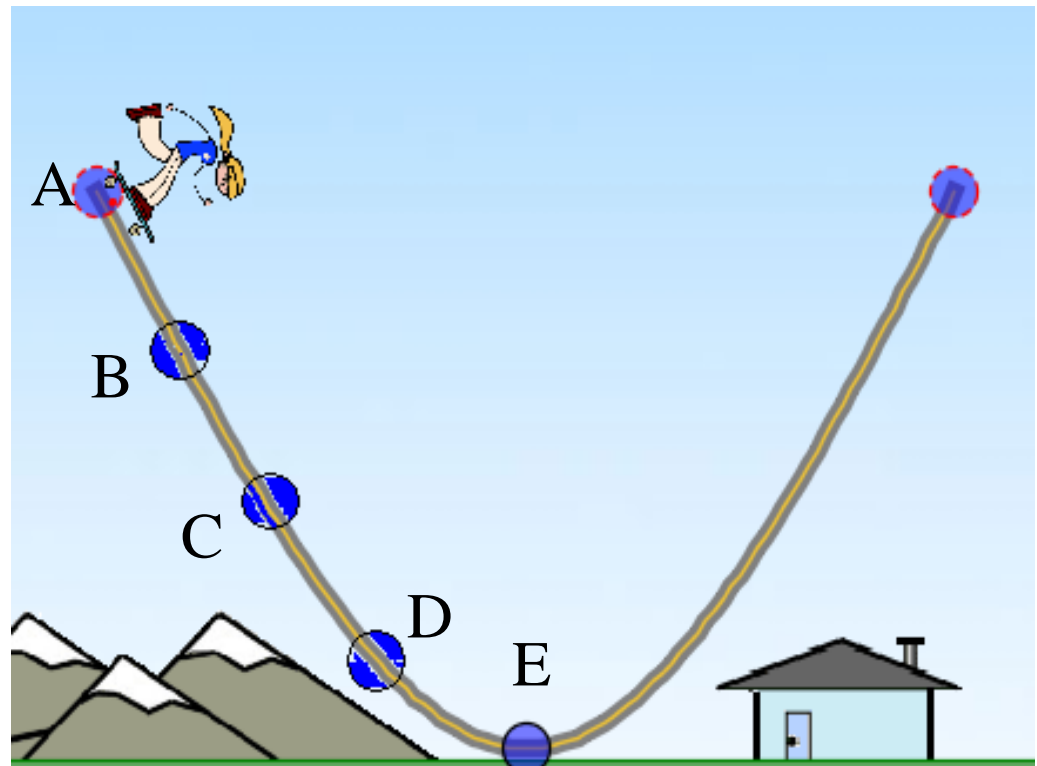
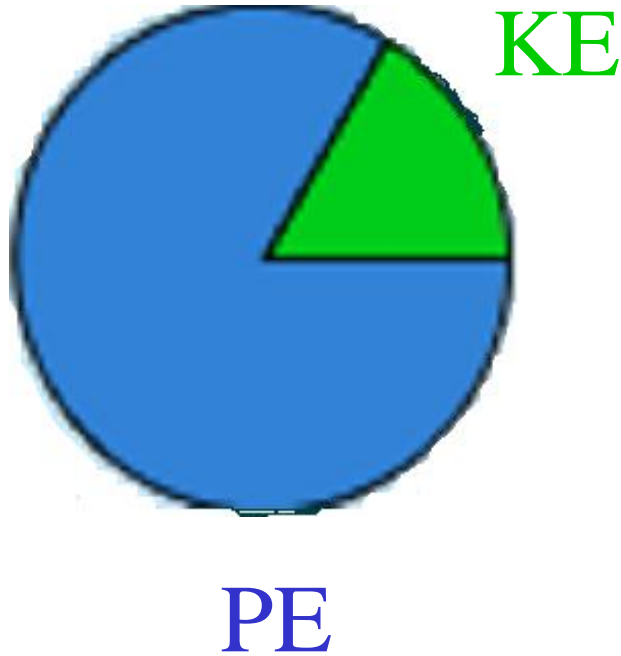

4. If the ball is at point 4, which chart could represent the ball's energy?

PE KE

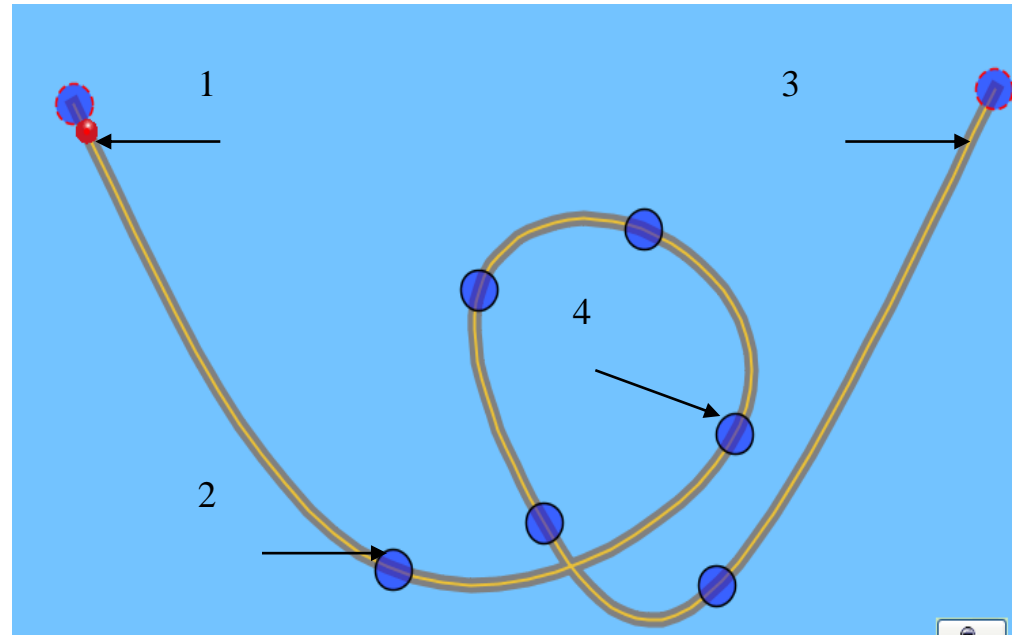
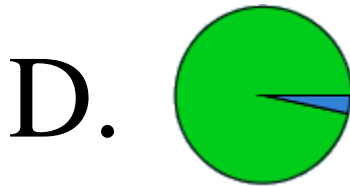
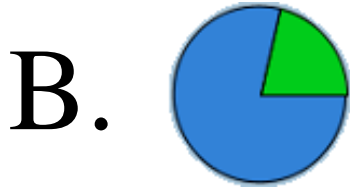
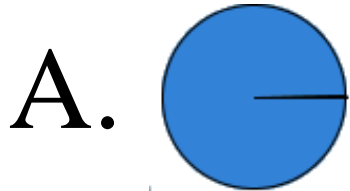

5. If a heavier ball is at point 4, how would the pie chart change?

A. No changes

B. The pie would be larger

C. The PE part would be larger

D. The KE part would be larger

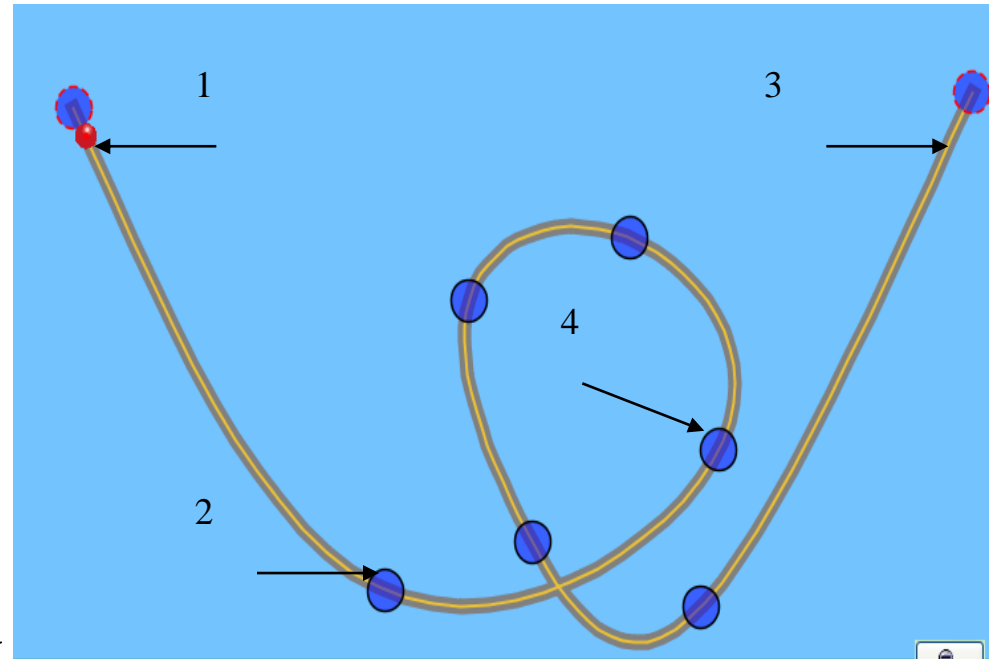
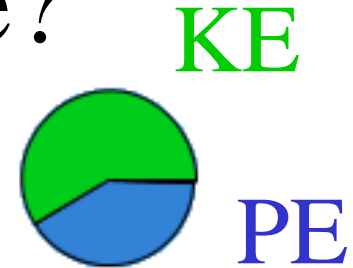

6. As the ball rolls from point 4, the KE bar gets taller. Which way is the ball rolling?

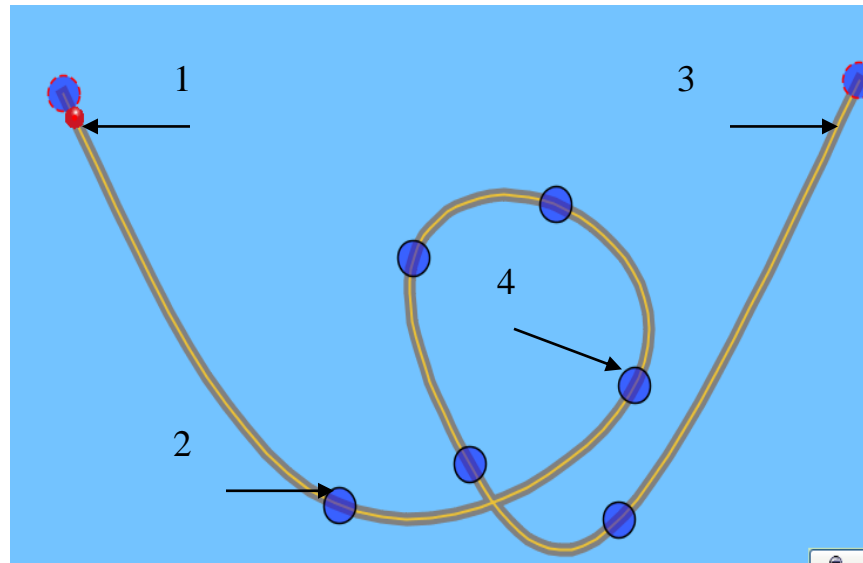
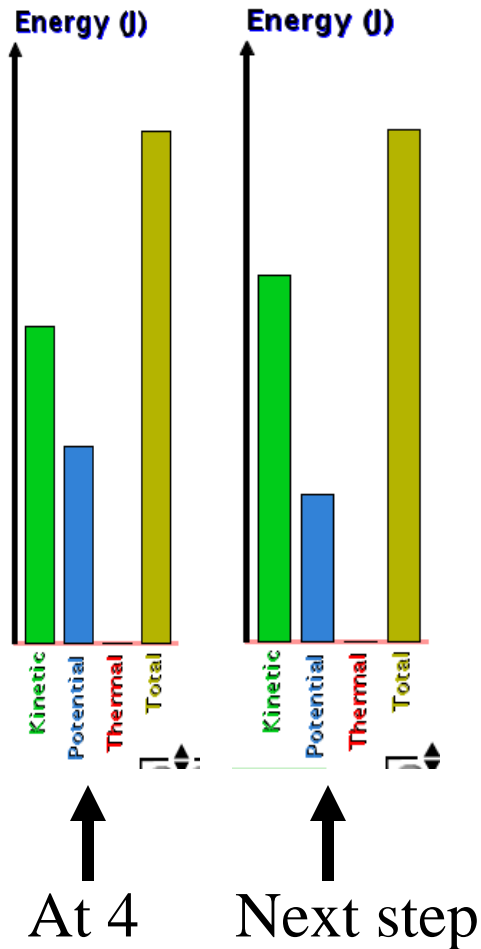

A. Up

B. Down

C. not enough info

7. The Energy chart of a boy skating looks like this →

How would you describe his speed?

- A. He is at his maximum speed
- B. He is stopped
- C. He is going his average speed
- D. He is going slow
- E. He is going fast

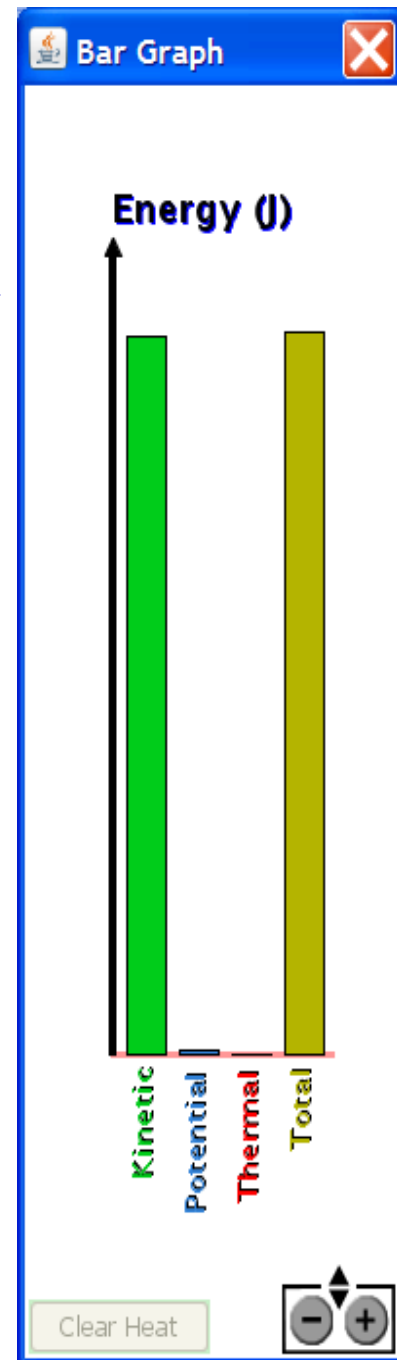

8. The Energy chart of a boy skating looks like this →

How would you describe his speed?

- A. He is at his maximum speed
- B. He is stopped
- C. He is going his average speed
- D. He is going slow
- E. He is going fast

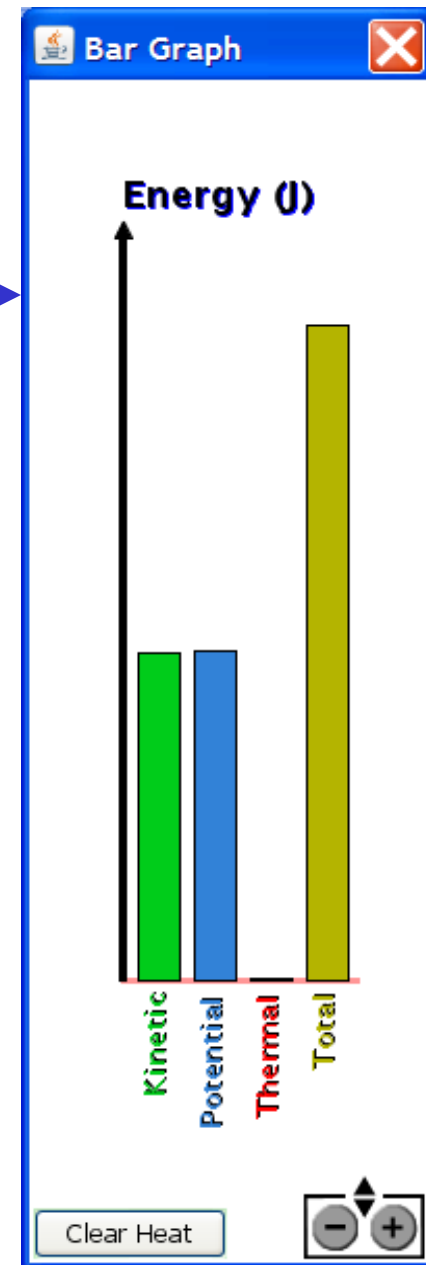



# 9. Select a letter for each: stopped, slow and fast

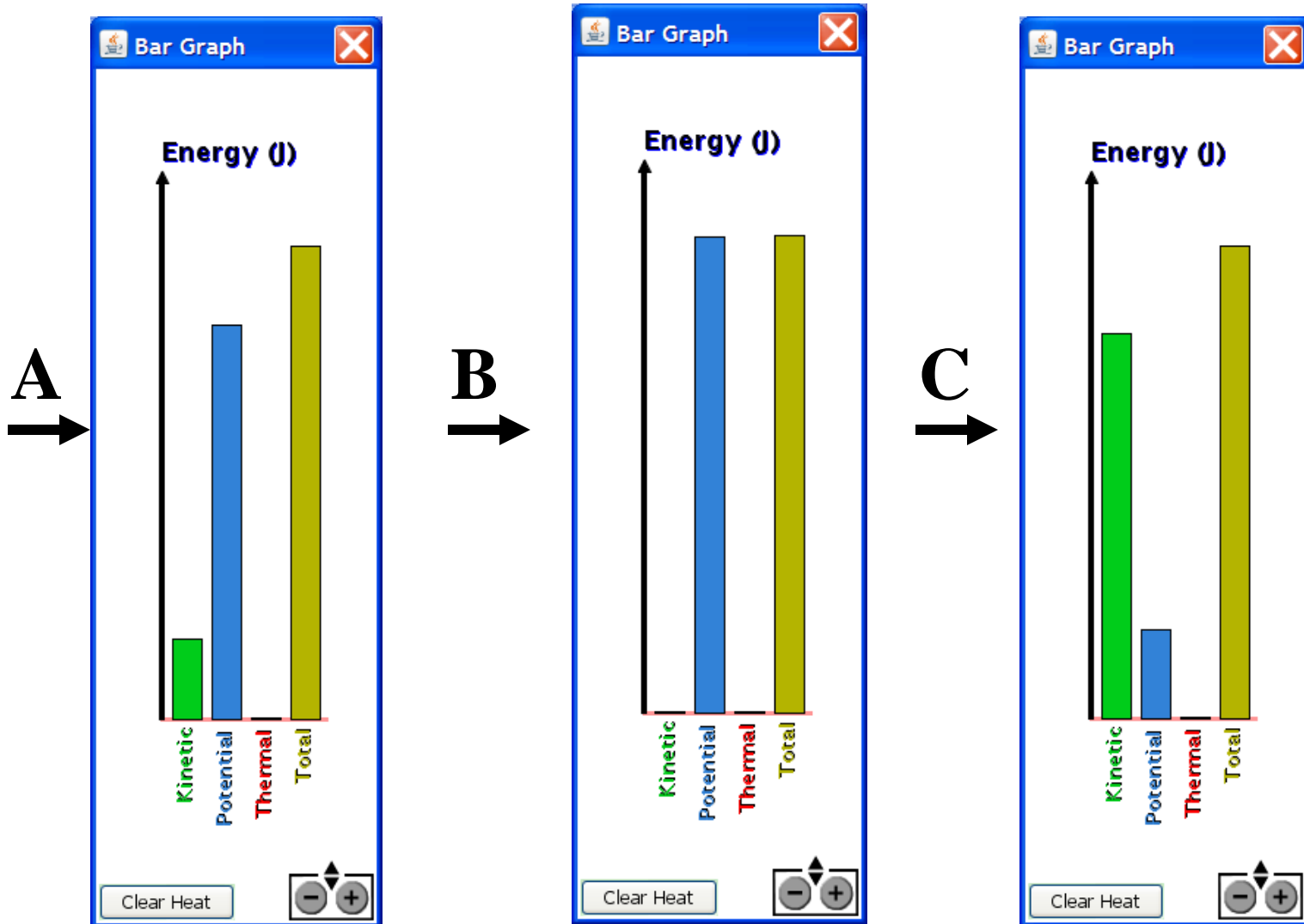

10. Sketch this energy position graph. Label where the 5 spots, A-E, could be

A. He is going his maximum speed

B. He is stopped

C. He is going his average speed

D. He is going slow

E. He is going fast

## Energy vs Position

PE KE

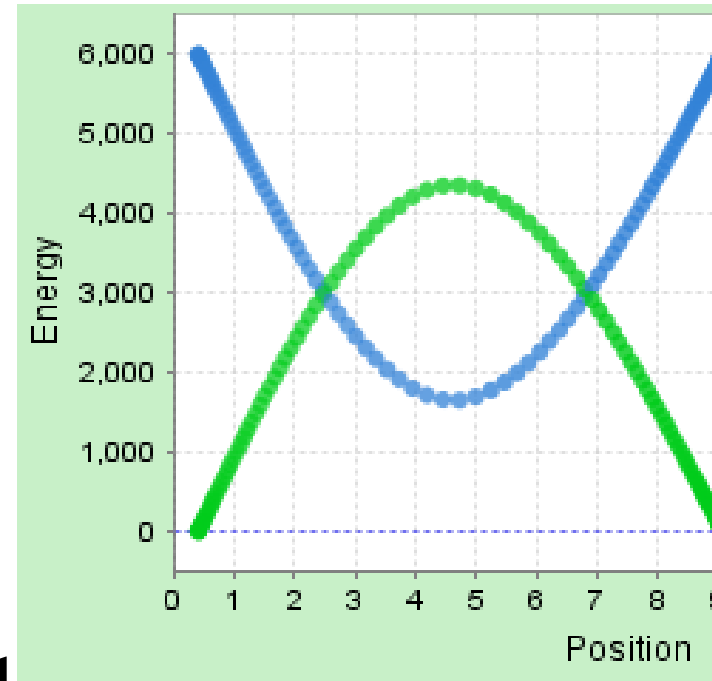



1. How high will pendulum rise?

A) Less than  $h$

B)  $h$

C) More than  $h$

$h$

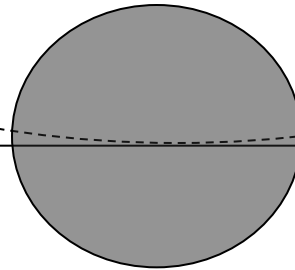
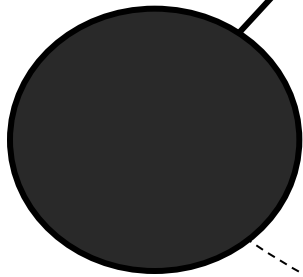

**Reference level ( $h = 0$ )**

Pendulum height

2. A 5000 kg coaster is released 20 meters above the ground on a frictionless track. What is the approximate speed at ground level? (point A)

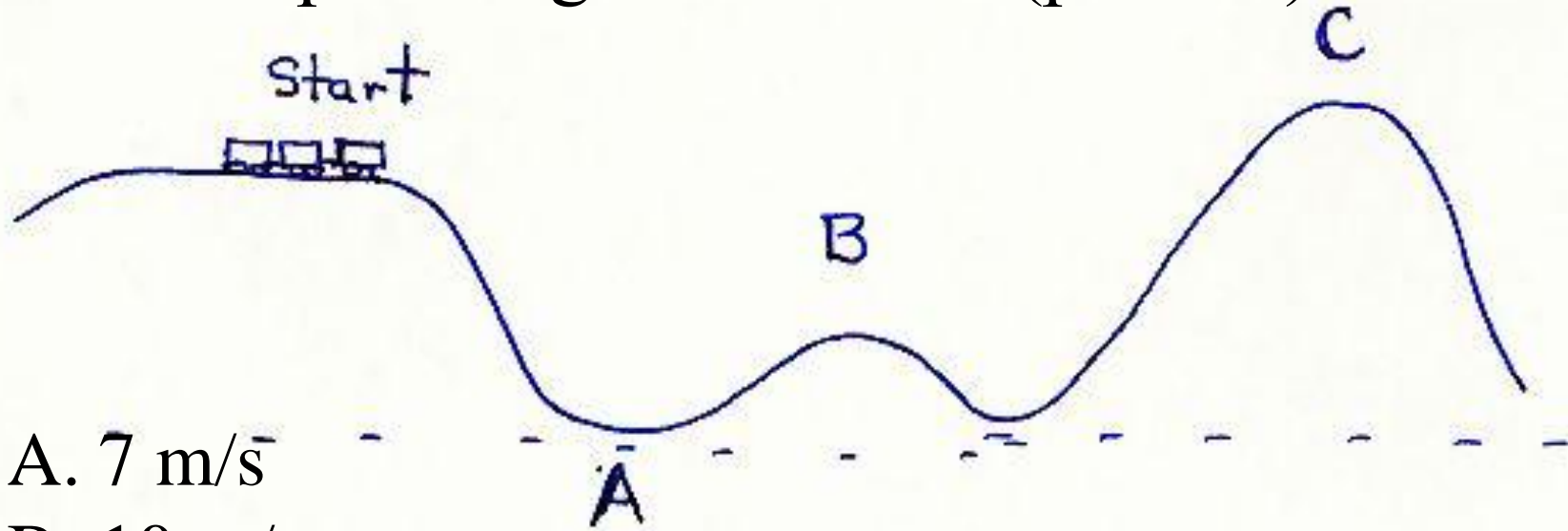

- A. 7 m/s
- B. 10 m/s
- C. 14 m/s
- D. 20 m/s
- E. none of the above

3. What is its approximate speed at 10 meters high (point B )?

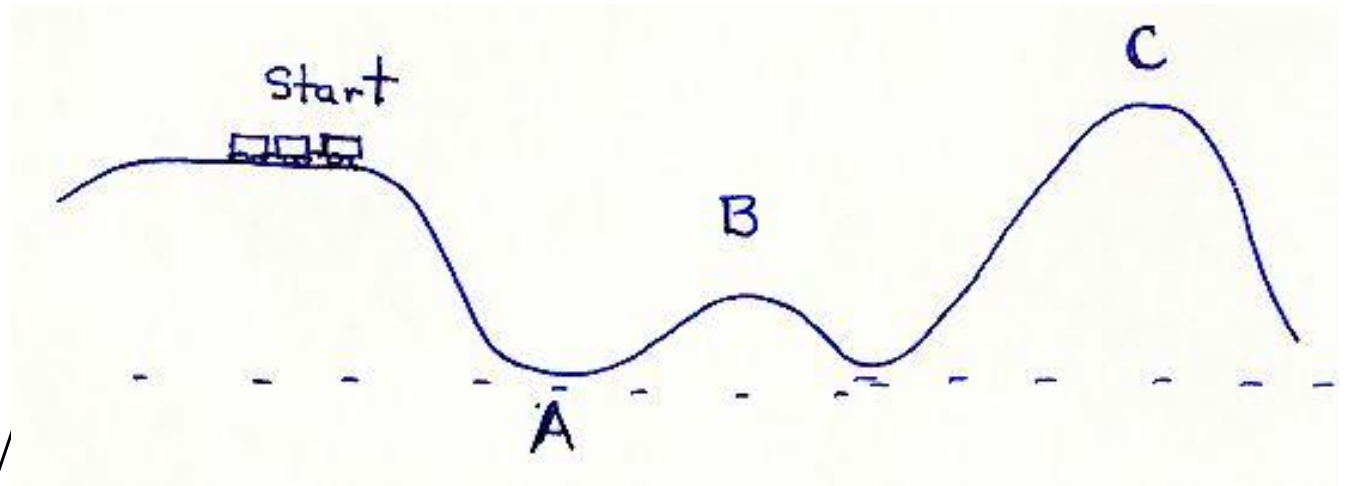

- A) 7 m/s
- B) 10 m/s
- C) 14 m/s
- D) 20 m/s
- E) none of the above

4. How fast would the coaster have to be going at the start to reach 21 meters high (point C)?

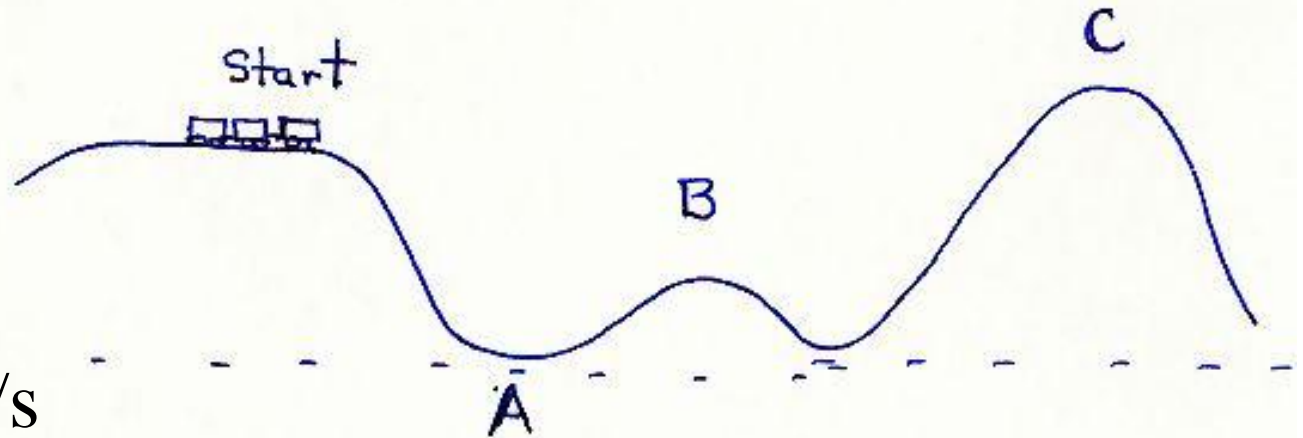

- A) 1.1 m/s
- B) 3.2 m/s
- C) 4.5 m/s
- D) 20 m/s



5. Calculate velocity at B if  $h = 0.45 \text{ m}$ ,  $g = 10 \text{ m/s}^2$

A) 3 m/s

B) 4.5 m/s

C) 7.5 m/s

D) 9 m/s

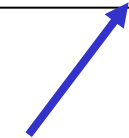
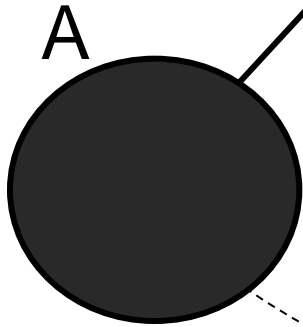

**Reference level ( $h = 0$ )**

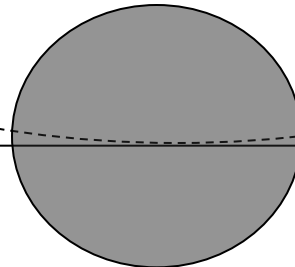

**B**

6. A block initially at rest is allowed to slide down a frictionless ramp and attains a speed  $v$  at the bottom. To achieve a speed  $2v$  at the bottom, how many times higher must the new ramp be?

A)  $\sqrt{2}$

B) 2      C) 3      D) 4      E) none of these.

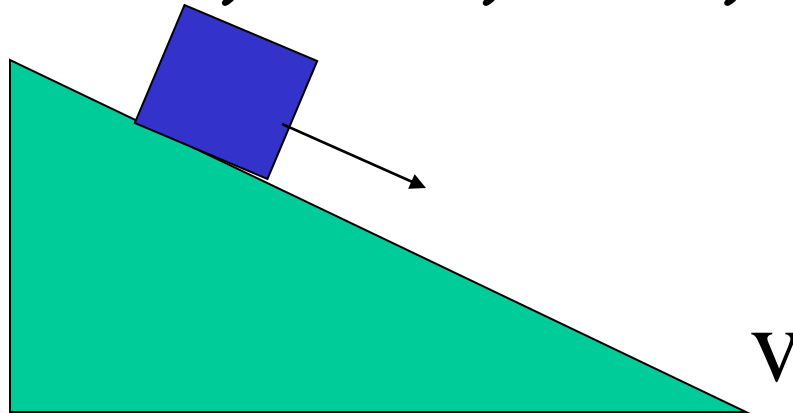



6. A block initially at rest is allowed to slide down a frictionless ramp and attains a speed  $v$  at the bottom. To achieve a speed  $2v$  at the bottom, how many times higher must the new ramp be?

- A)  $\sqrt{2}$       B) 2      C) 3      **D) 4**      E) none of these.

$$mgh_{\text{top}} + \cancel{0_{\text{KE}}} + \cancel{0_{\text{work}}} = \cancel{0_{\text{PEg}}} + \frac{1}{2} m v_{\text{bottom}}^2$$

First ramp:  $h_{\text{top}} \propto v_{\text{bottom}}^2$

2nd ramp:  $h'_{\text{top}} \propto (2v_{\text{bottom}})^2 = 4 (v_{\text{bottom}}^2)$

$$h'_{\text{top}} = 4h_{\text{top}}$$

# Energy Skate Park 4

## Learning Goals:

Students will be able to use **Energy-Time** graphs to... at a given time.

- Estimate a location for the Skater on a track.
- Calculate the speed or height of the Skater *Friction and frictionless*.
- Predict energy distribution for tracks with and without friction.

By Trish Loeblein updated July 2008

The Friction concepts are not addressed in these clicker questions. Some screen images are included, but it would be better to have the sim running. I have used tracks that are the default or under Track menu for easy reproduction.

1. What will the speed of the 75kg Skater be at 2 seconds?

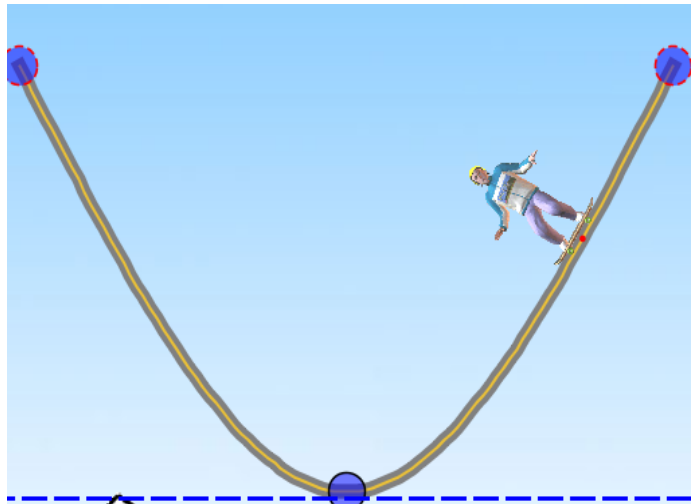

PE = 0 at dotted line

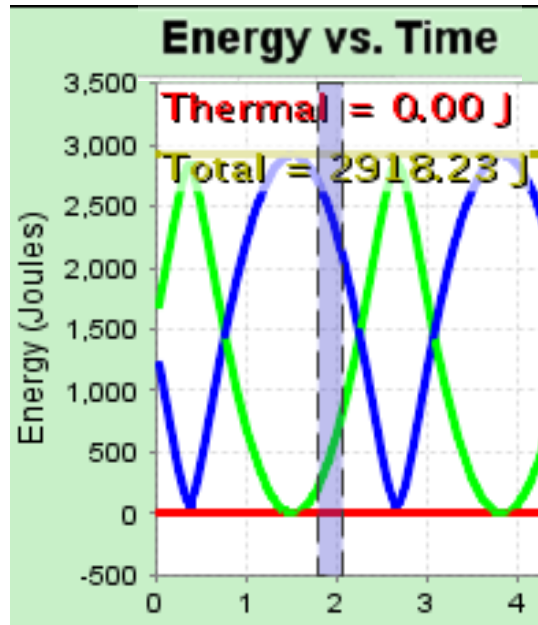

Total = 2918 J

KE = 509 J

PE = 2408 J

- A. 14m/s    B. 8.8m/s    C. 8.0m/s    D. 3.7m/s

Comments for question 1: This is the default track with the PE line moved up to the track

$$KE = \frac{1}{2}mv^2$$

$$509 = \frac{1}{2} * 75 * v^2$$

$$v = \sqrt{\frac{509 * 2}{75}} = 3.7 \text{ m/s}$$

14 is no sqrt

8 uses PE

8.8 uses Total E

2. At what height is the 60kg Skater at 2 seconds?

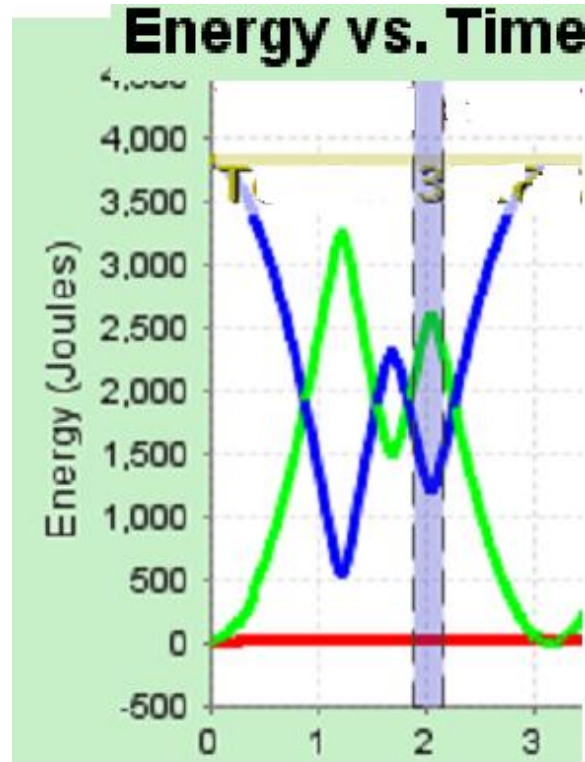
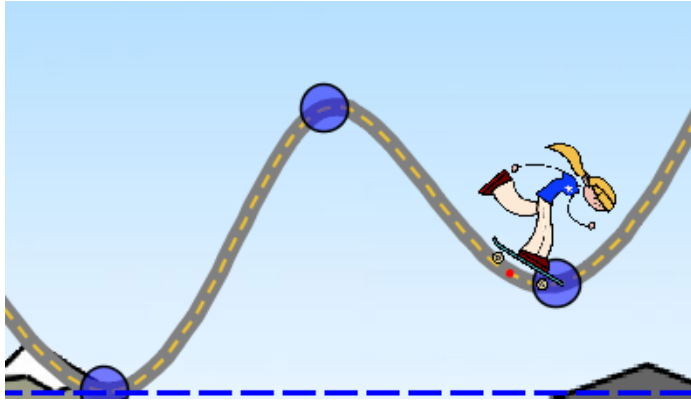

**Total = 3829 J**

**KE = 2429 J**

**PE = 1365 J**

- A. 6.5m    B. 4.2m    C. 2.3m    D. 1.9m

Comments for question 2: I used the Double well roller coaster track with the Skater changed to the girl and I moved the PE line to the bottom of the first well. Then I started from the “Return Skater” position.

Comments about #3. I would show the slide, have the students make a drawing and then show the options on the next slide.

$$h = \frac{PE}{mg} = \frac{1365}{60 * 9.81} = 2.3m$$

6.5 uses Total E, 4.2 uses KE, 1.9 uses mass of 75,

3. Draw what you think the energy graph look like at 10 seconds.

## Energy vs. Time

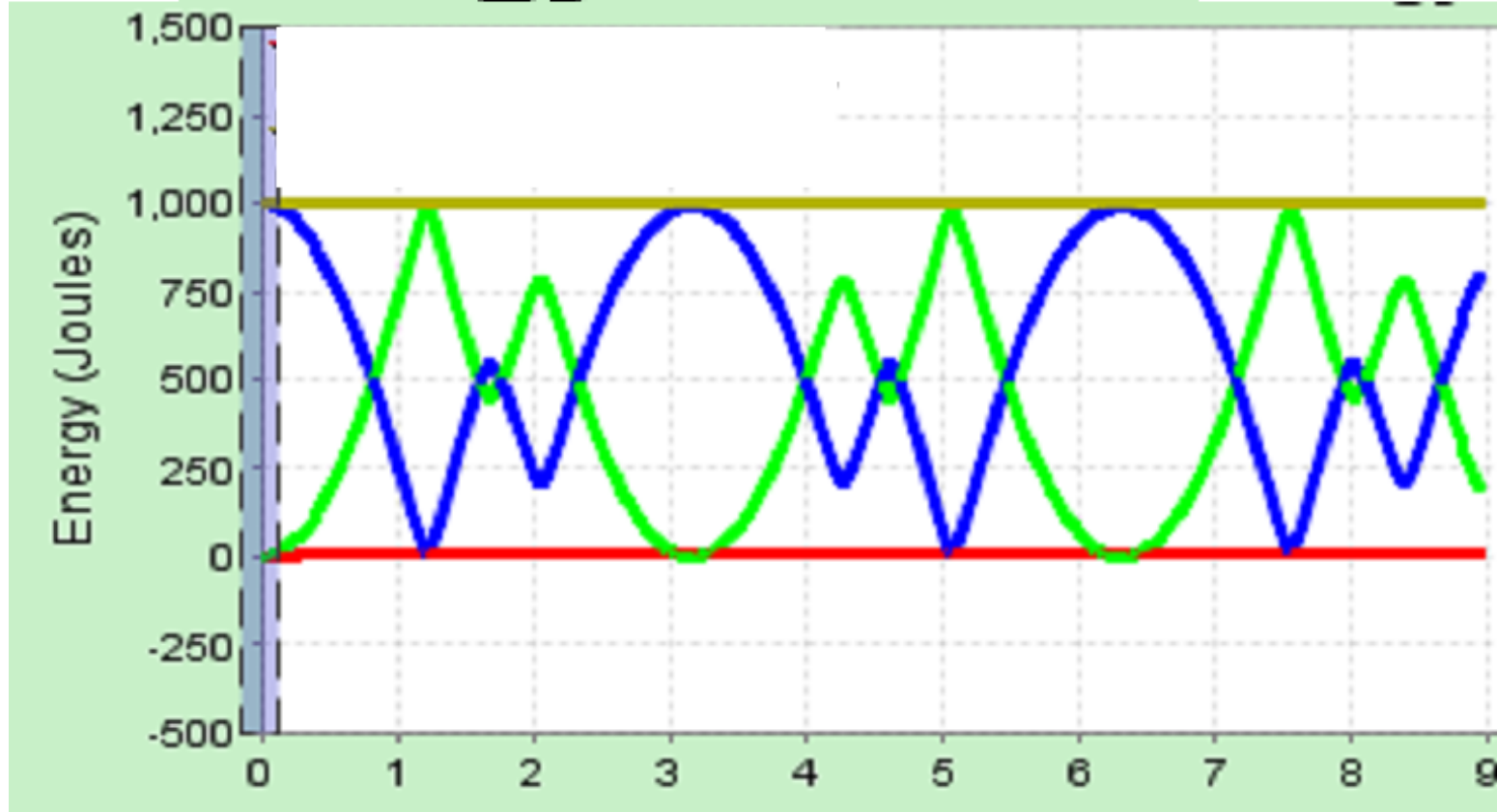

### 3. The energy graph at 10 s:

**Energy vs. Time**

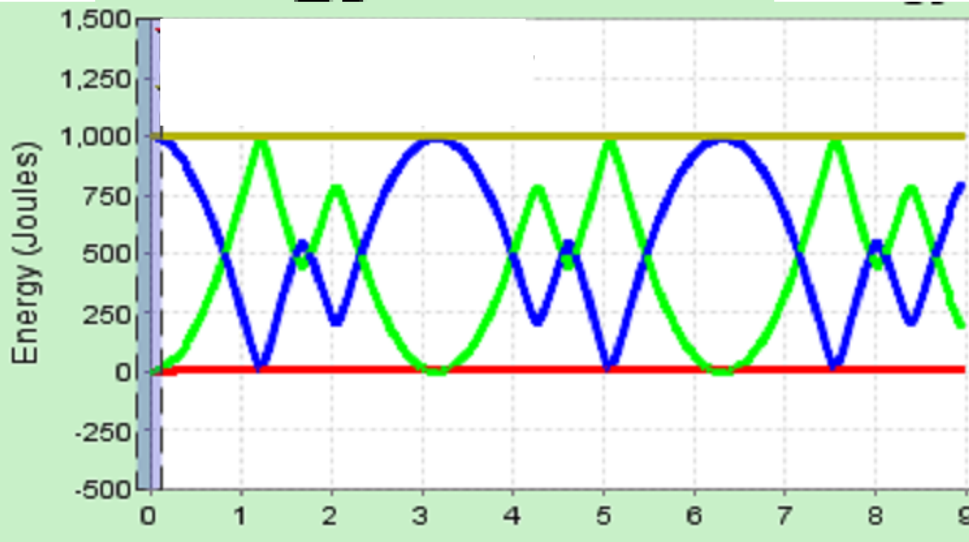

A

B

C

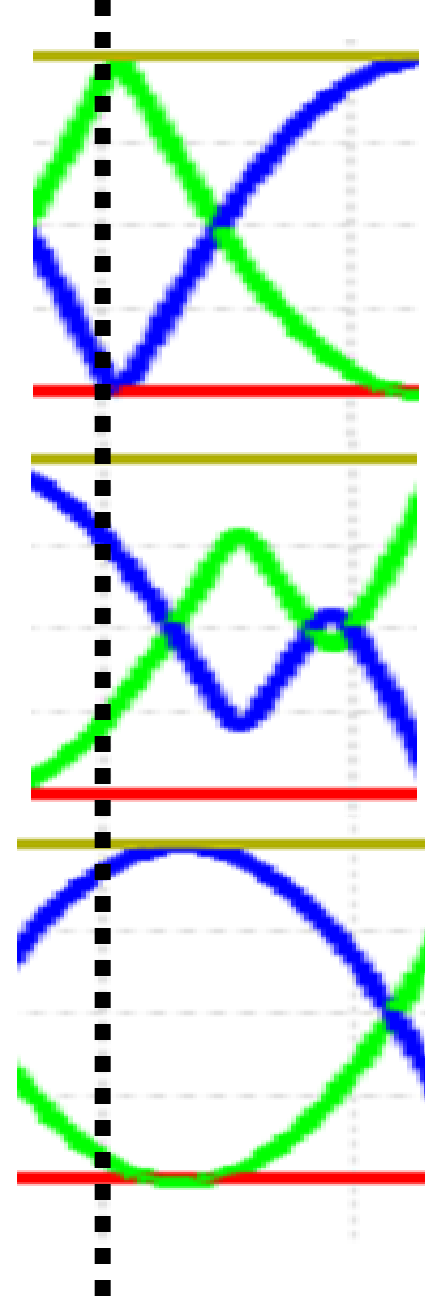

10



Comments and answer to 3: I used the double well roller coaster again with a ball at 18 kg for #3 and #4

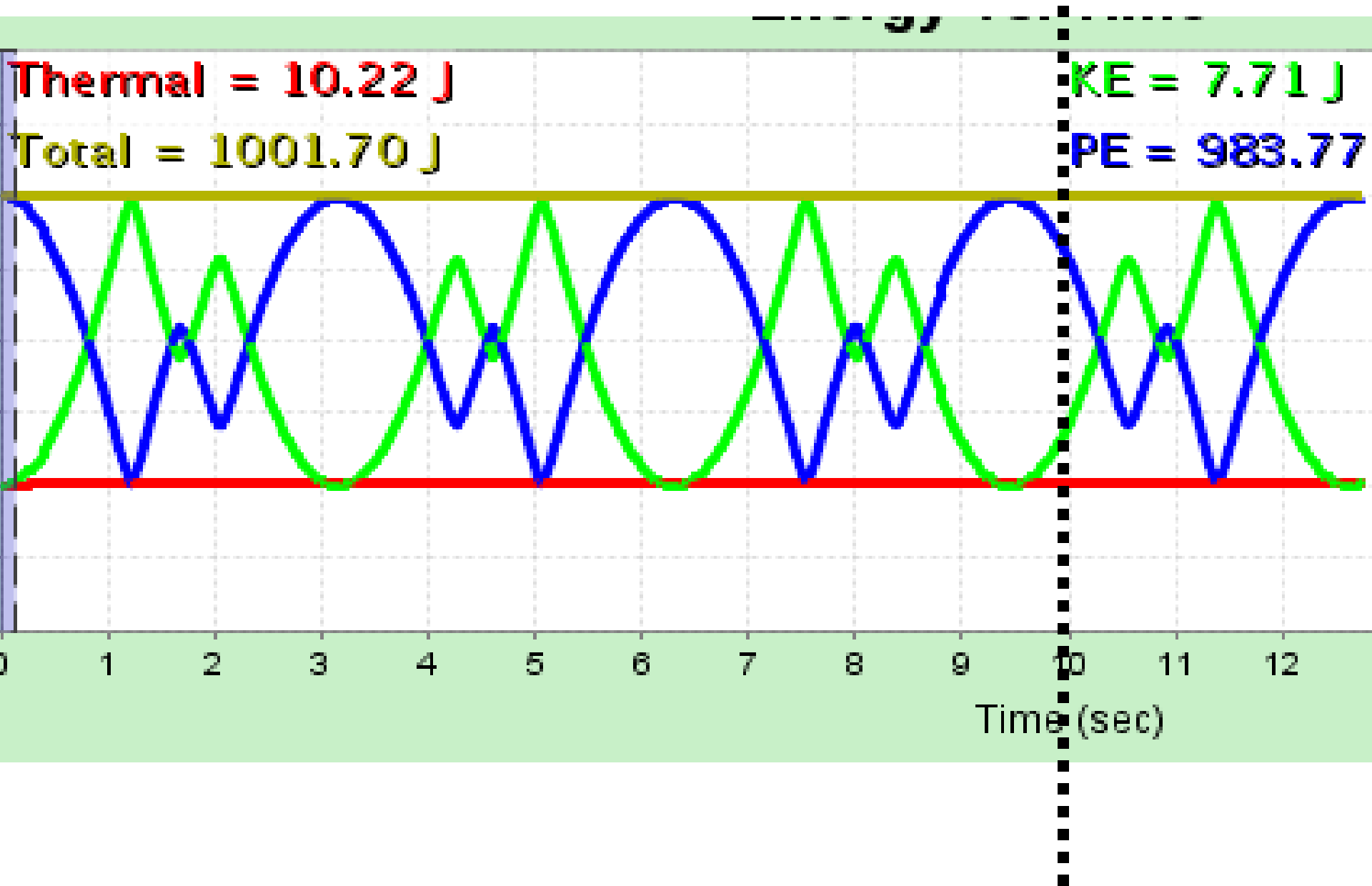

4. What might the ball be doing at 5 seconds?

- A. Going left to right at the lower dip
- B. Going right to left at the lower dip
- C. Going left to right at the higher dip
- D. Going right to left at the higher dip

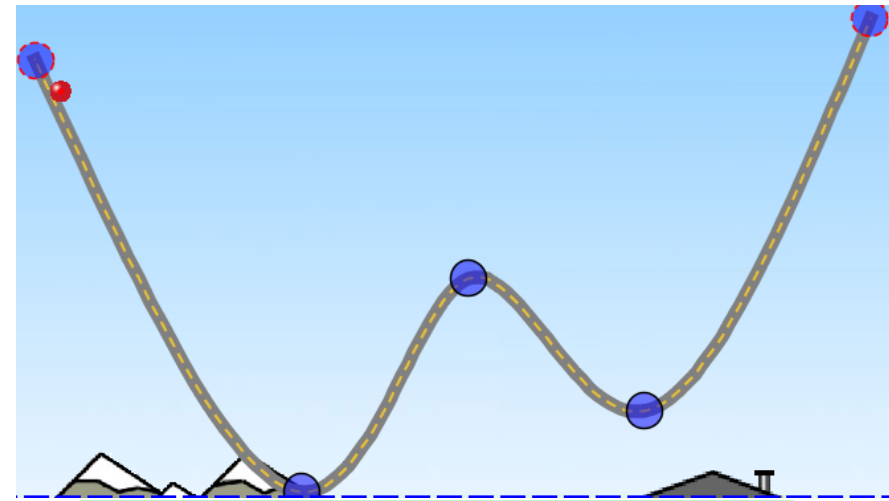

**Energy vs. Time**

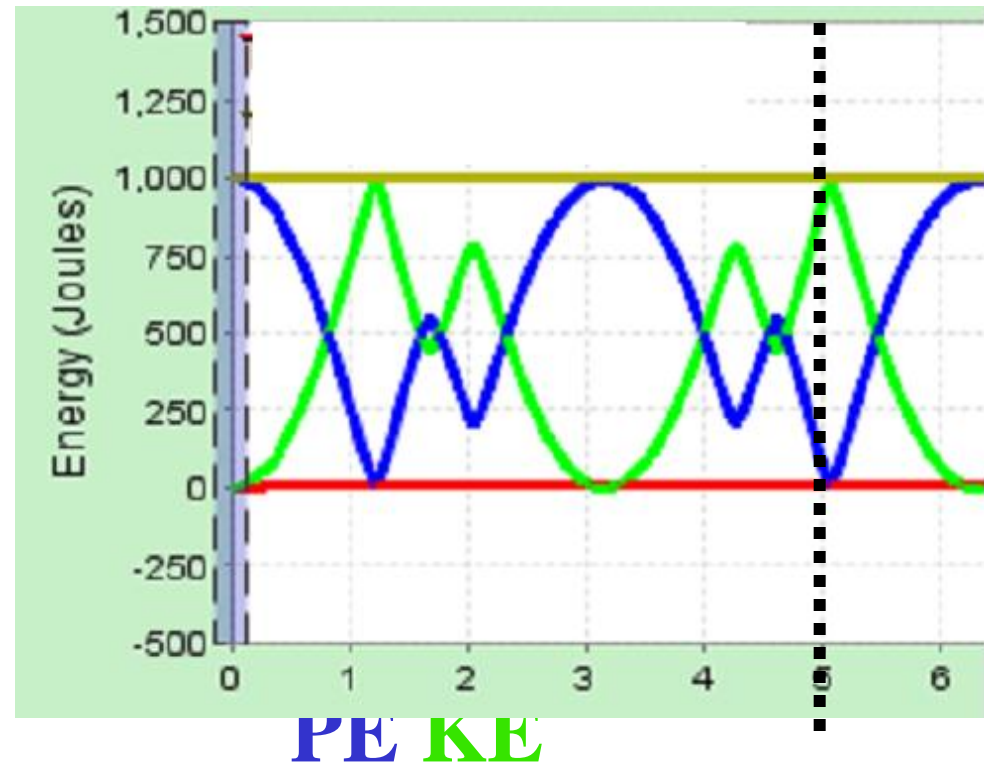

# Answer to 4

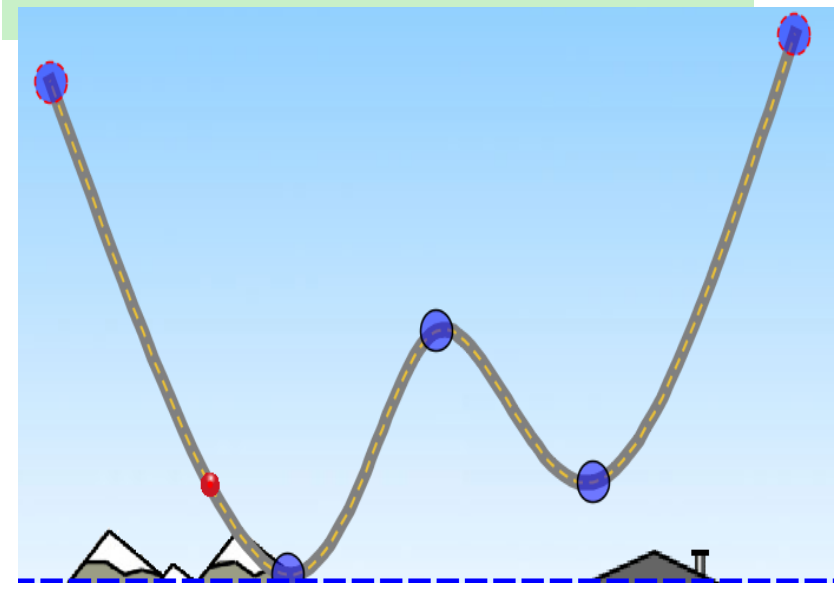
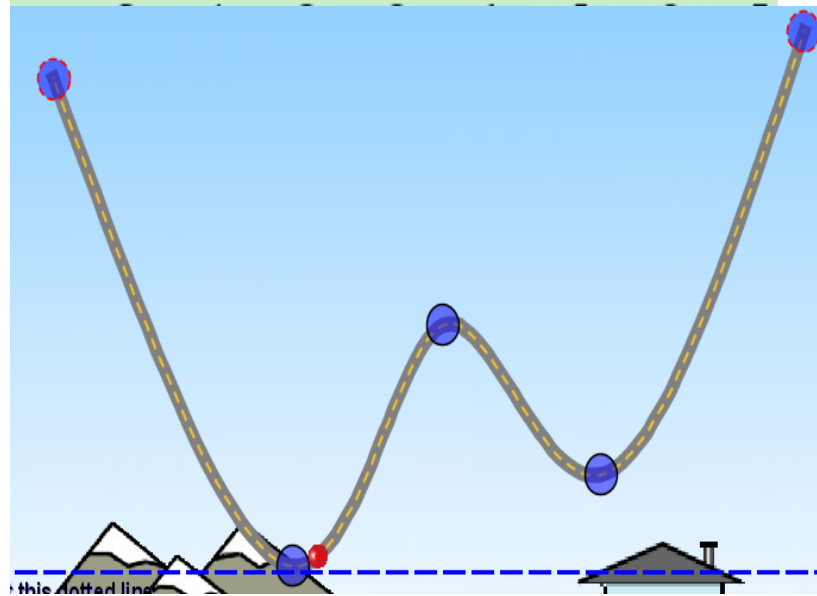
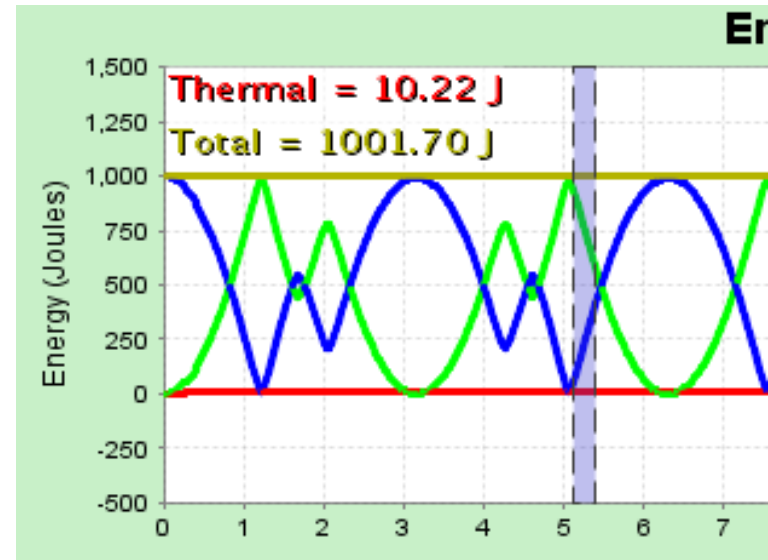
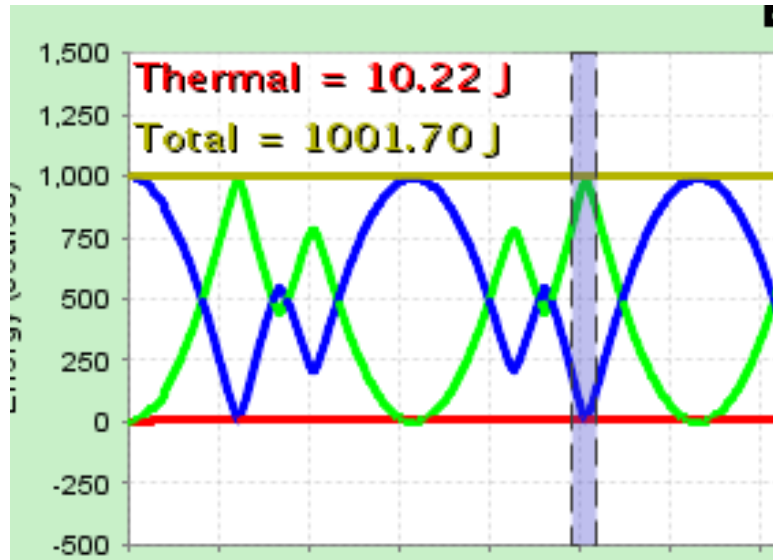

# Clicker questions for Projectile Motion

Trish Loeblein

June 08

Download the lesson plan and student directions for the lab [HERE](#)

There are some screen shots included to illustrate answers, but it would be better to use the simulation during discussion.

[phet.colorado.edu](http://phet.colorado.edu)

# Learning Goals

- Predict how varying initial conditions effect a projectile path

These are part of the lesson, but not addressed in the clicker questions:

- Use reasoning to explain the predictions.
- Explain projectile motion terms in their own words.
- Describe why using the simulation is a good method for studying projectiles.

# 1. Which car will go farther?

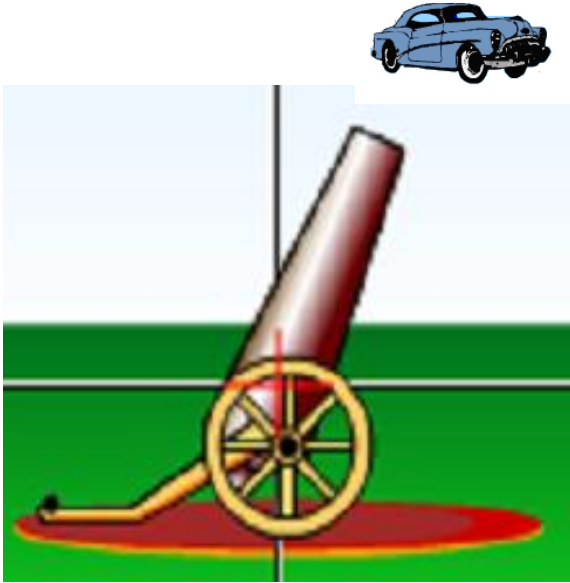

A



B

initial speed(m/s)	18
mass(kg)	2
diameter(m)	0.1
<input type="checkbox"/> Air Resistance	

C They will go the same distance

## 2. Which will be in the air longer?

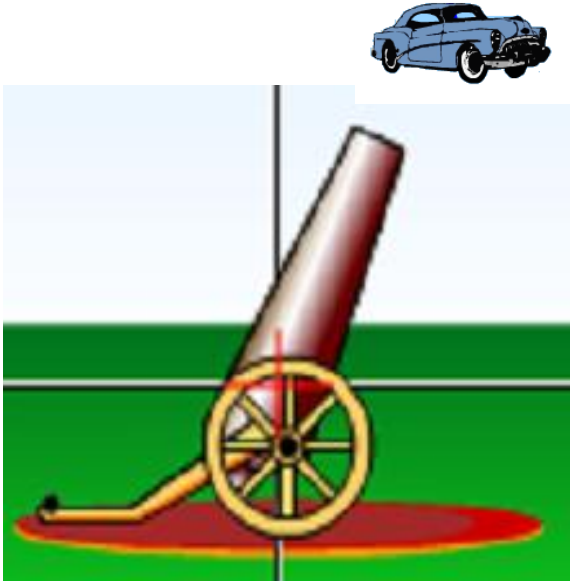

A

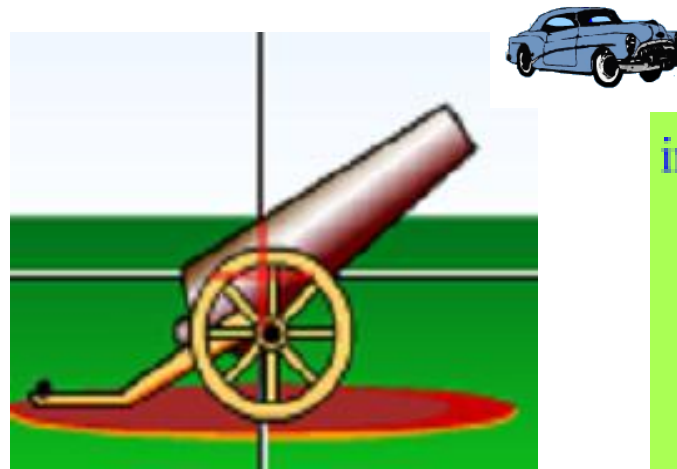

B

initial speed(m/s)	18
mass(kg)	2
diameter(m)	0.1
<input type="checkbox"/> Air Resistance	

C same time  
in air

### 3. Which car will go higher?

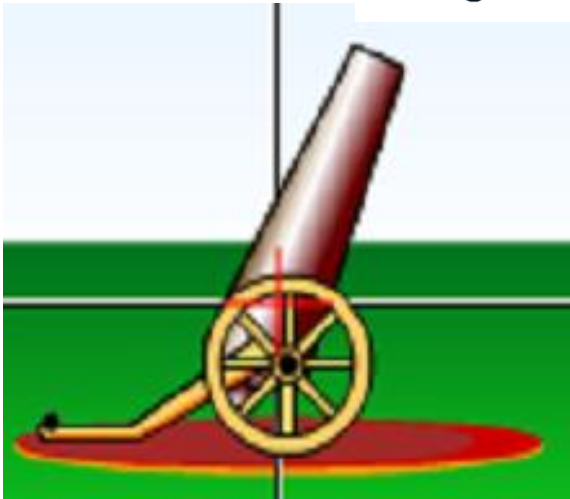

A

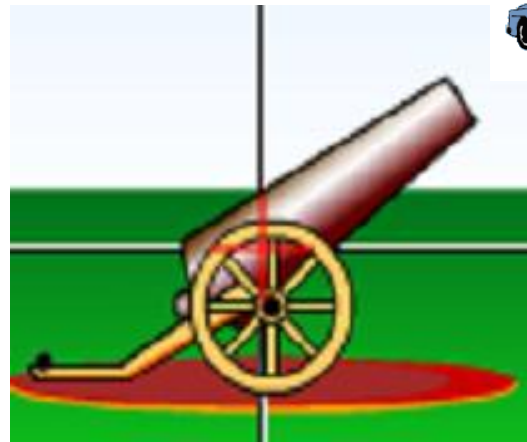

B

initial speed(m/s)	18
mass(kg)	2
diameter(m)	0.1
<input type="checkbox"/> Air Resistance	

C They will go the same height



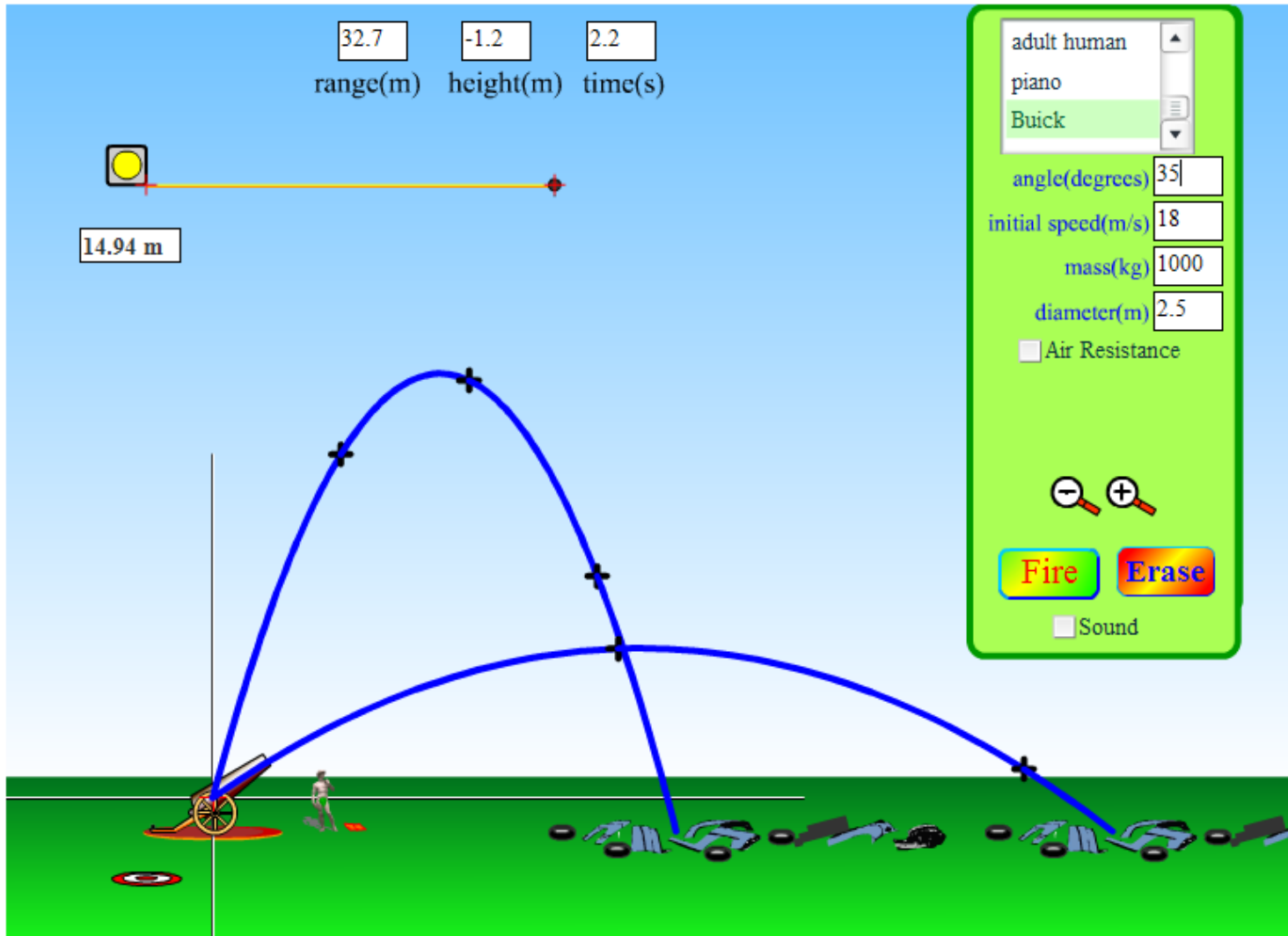

Time for 75 degrees 3.6 s, 35 degrees 2.2

# 4. Which will go farther?



Buick

angle(degrees)	75
initial speed(m/s)	18
mass(kg)	1000
diameter(m)	2.5

Air Resistance

A

tankshell

angle(degrees)	75
initial speed(m/s)	18
mass(kg)	150
diameter(m)	0.15

Air Resistance

B

C They will go same distance

# 5. Which will go farther?



Buick	
angle(degrees)	75
initial speed(m/s)	18
mass(kg)	1000
diameter(m)	2.5
<input checked="" type="checkbox"/> Air Resistance	

A

tankshell	
angle(degrees)	75
initial speed(m/s)	18
mass(kg)	150
diameter(m)	0.15
<input checked="" type="checkbox"/> Air Resistance	

B

C They will go same distance

# 6. Which will go higher?



Buick	
angle(degrees)	75
initial speed(m/s)	18
mass(kg)	1000
diameter(m)	2.5
<input checked="" type="checkbox"/> Air Resistance	

A

tankshell	
angle(degrees)	75
initial speed(m/s)	18
mass(kg)	150
diameter(m)	0.15
<input checked="" type="checkbox"/> Air Resistance	

B

C They will go same height

# 7. Which will go farther?



tankshell

angle(degrees) 75

initial speed(m/s) 18

mass(kg) 150

diameter(m) 0.15

Air Resistance

tankshell

angle(degrees) 75

initial speed(m/s) 18

mass(kg) 150

diameter(m) 10

Air Resistance

A

B

C They will go same distance

# Results 4-7 Small vs large object

**Red** paths have air resistance

Without air resistance no difference

Shell drag .05

Buick drag 1.3 Shell

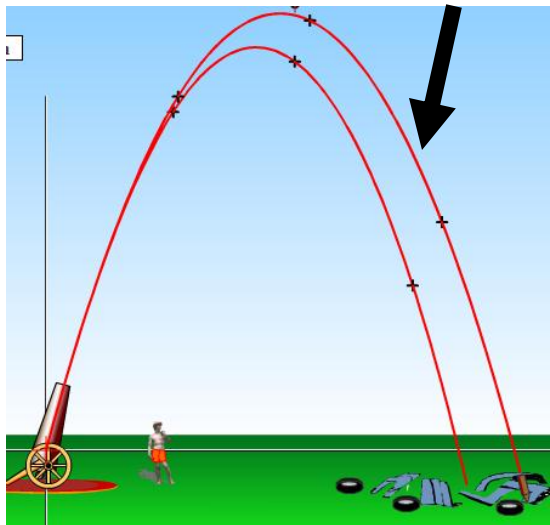

Buick shown

(Shell has identical paths)

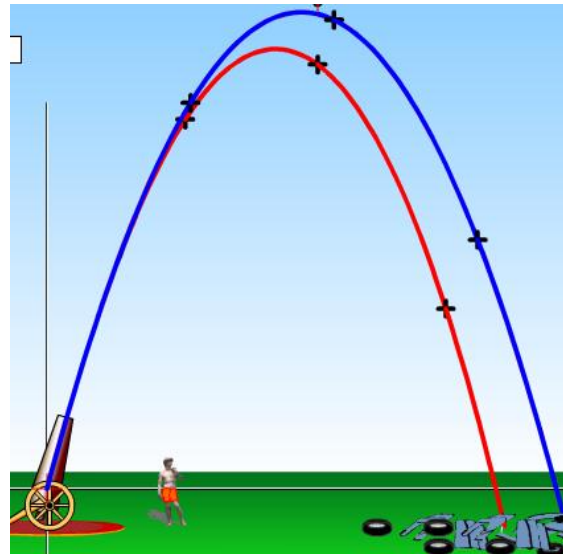

Small Shell

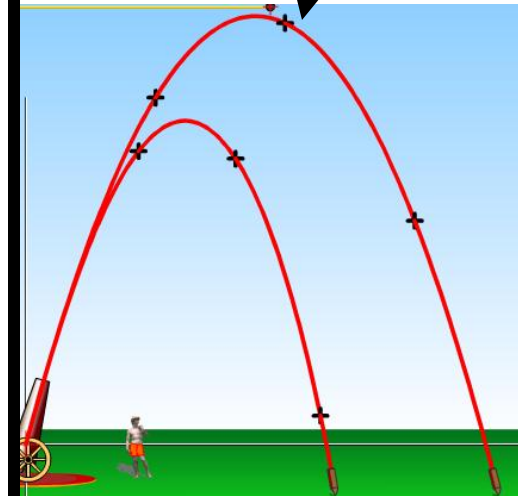

# Sound activity

I used questions 1-8 with the sound activity and the rest on the next day.

**Learning Goals: Students will be able to**

- **Explain how different sounds are modeled, described, and produced.**

**Design ways to determine the speed, frequency, period and wavelength of a sound wave model.**

1. A student started the speaker by clicking on the stopwatch. How many sound waves are there in this trial?

A. 3

B. 5

C. 4

D. 8

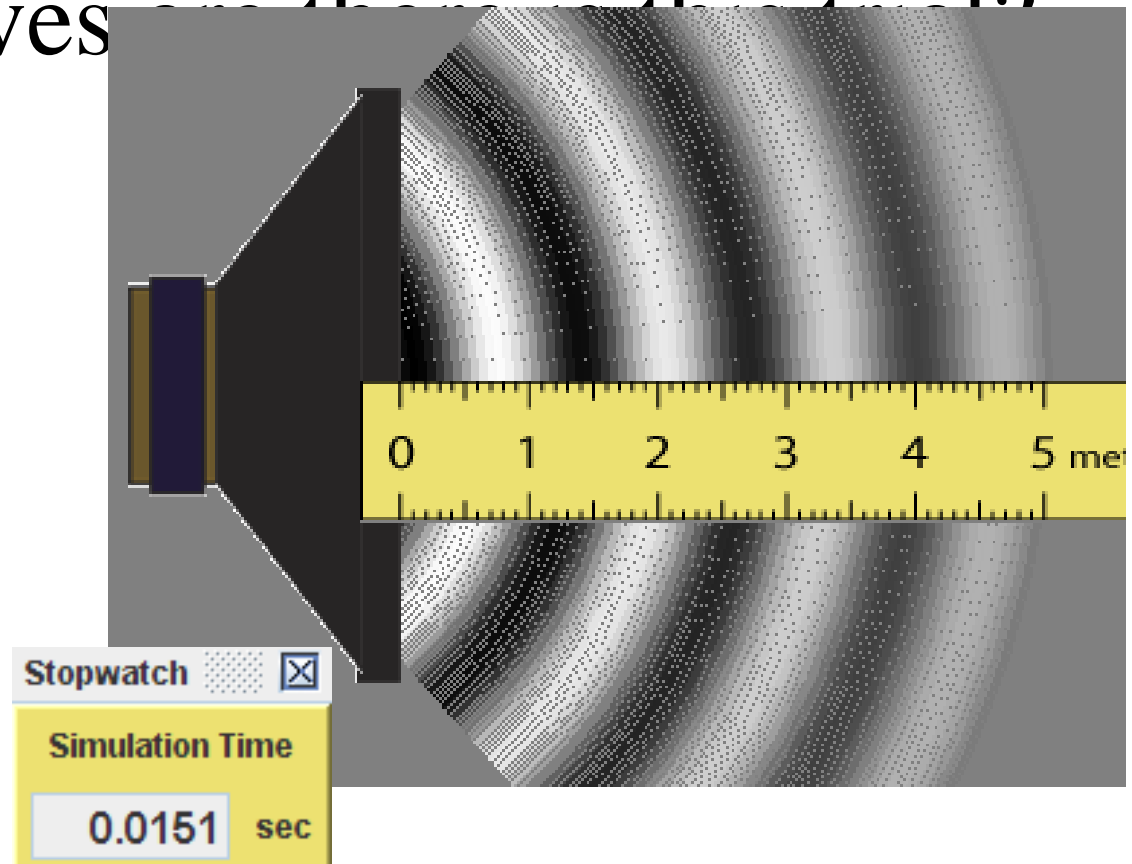



## 2. What is the speed of the sound waves shown here?

- A. 300 m/s
- B. 330 m/s
- C. 0.0030 m/s
- D. 66 m/s

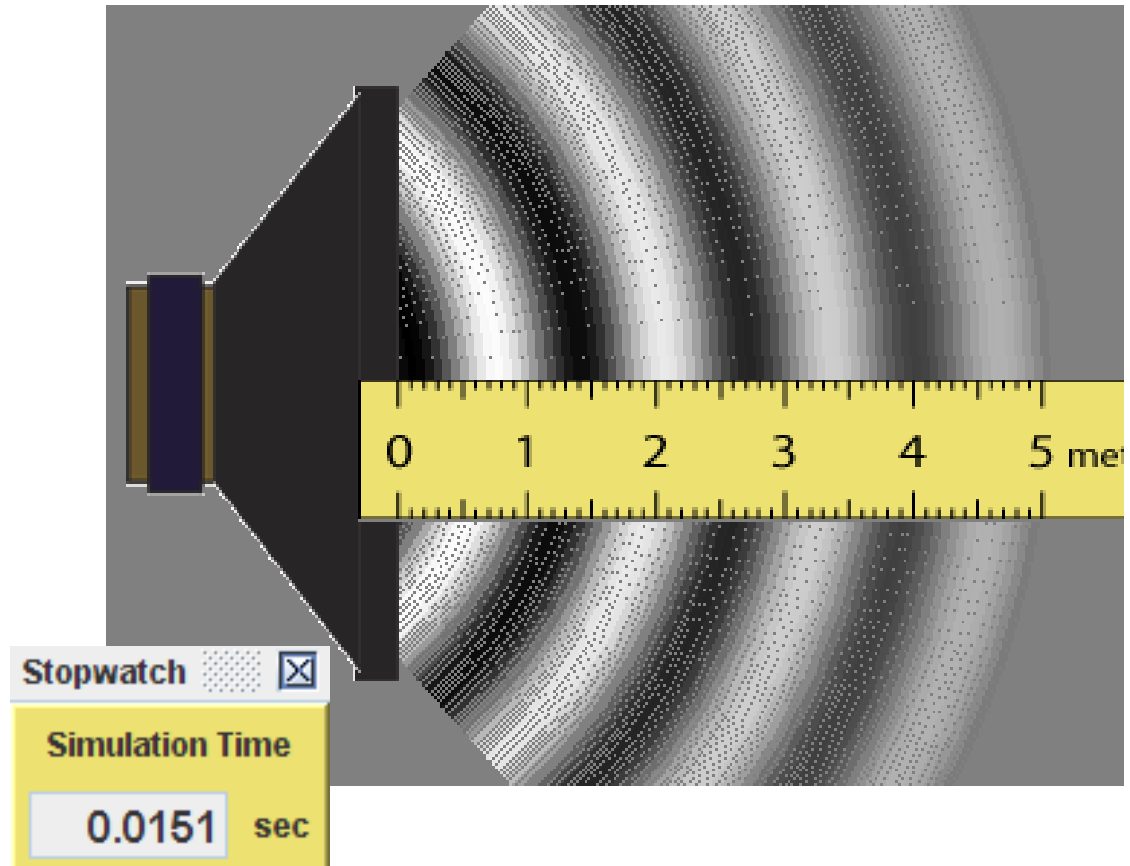

### 3. What is the frequency of the sound waves shown here?

- A. 0.0037 hz
- B. 66 hz
- C. 260 hz
- D. 300 hz
- E. 330 hz

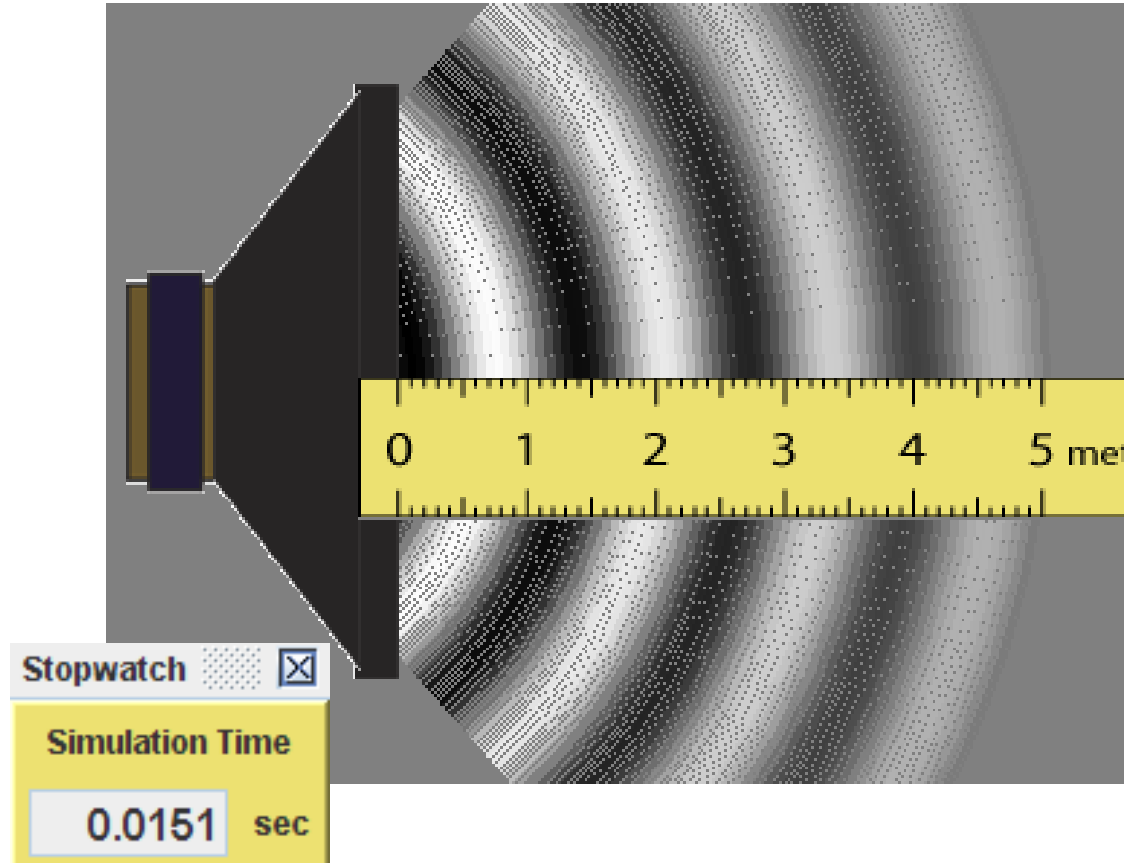

# 4. What is the period of the sound waves shown here?

- A. 0.0151 s
- B. 0.0037 s
- C. 260 s
- D. 300 s
- E. 330 s

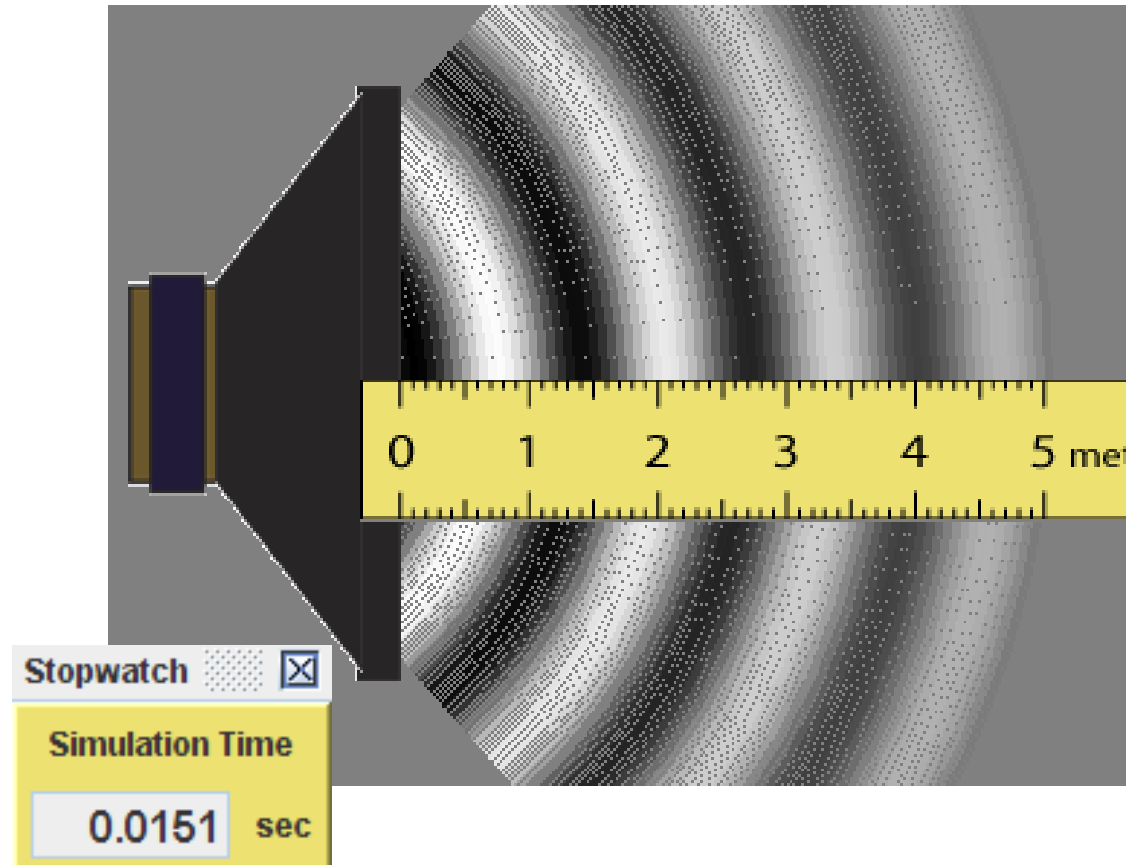

# 5. What is the wavelength of the sound waves shown here?

- A. 5 m
- B. 1.3 m
- C. 1 m
- D. 0.71 m
- E. 300 m

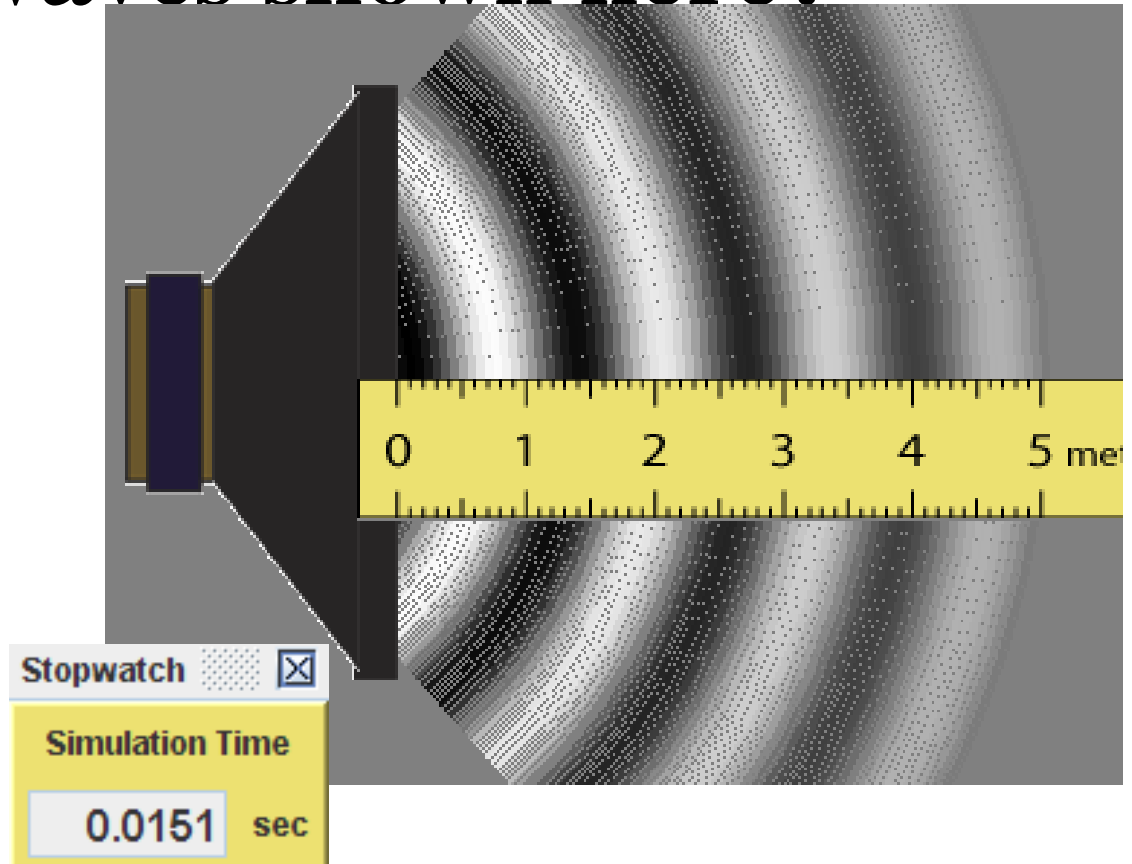

6. If your lab partner moved the frequency slider to the left so that it changed from 500 to 250 the period would be



- A. twice as big
- B.  $1/2$  as big
- C. Stays the same
- D.  $1/4$  times as big
- E. Not enough information to decide

7. If you moved the slider to the far right, doubling the amplitude, the period would be...

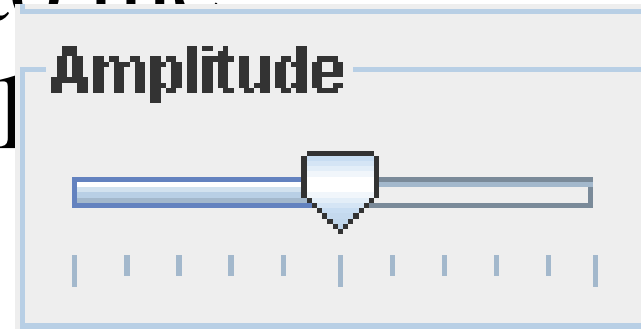

- A. twice as big
- B.  $1/2$  as big
- C. Stays the same
- D.  $1/4$  times as big
- E. Not enough information to decide

## Sound waves traveling out

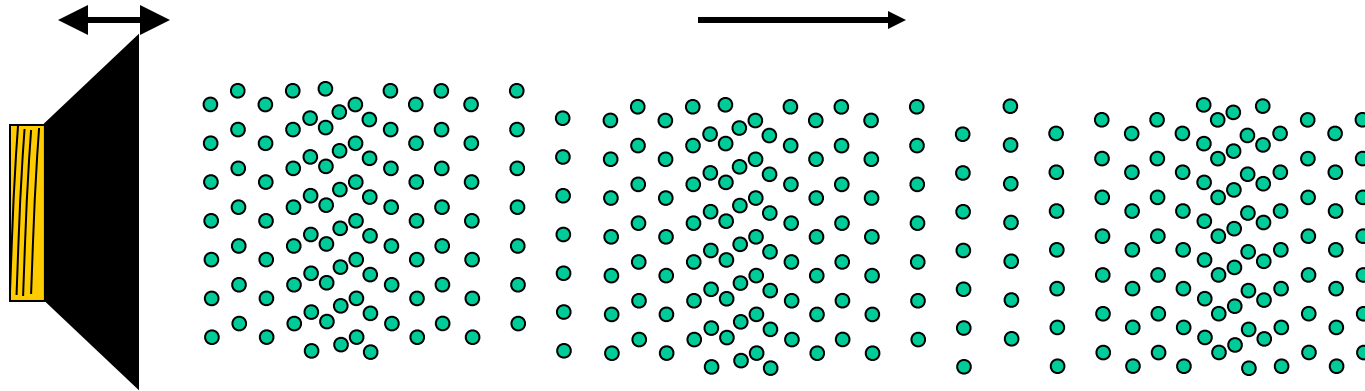

8. If the speaker vibrates back and forth at 200 Hz how much time passes between each time it produces a maximum in pressure?

- a. 0.2 seconds
- b. 0.200 seconds
- c. 0.005 seconds
- d. 0.02 seconds
- e. 0.05 seconds

9. A speaker is playing a constant note.

What happens to the sound when you

- 1) put a solid, thick glass jar over it and
- 2) pump the air out from the jar.

A) 1 => hardly any difference

2 => hardly any difference

B) 1 => hardly any difference

2 => much quieter

C) 1 => noticeably quieter

2 => hardly any MORE quiet

D) 1 => noticeably quieter

2 => much quieter still (near silence)

E) None of these/something else/??

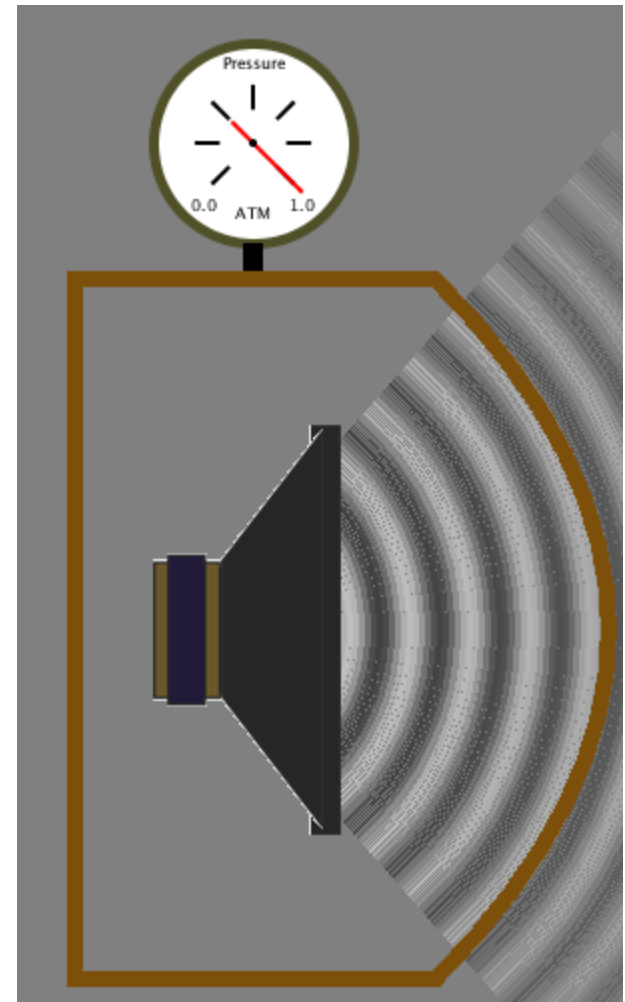



10. If you could put a dust particle in front of the speaker. Which choice below shows the *motion* of the dust particle?

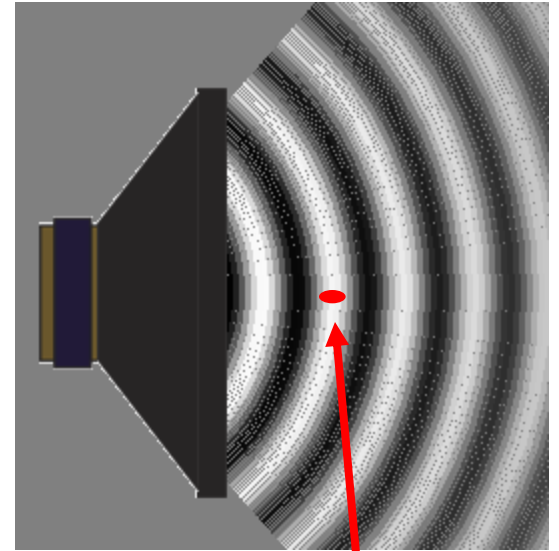

dust

- A)  $\updownarrow$  (up and down)
- B)  $\longrightarrow$  (steadily to the right)
- C)  $\longleftrightarrow$  (left and right)
- D) (no motion)
- E)  $\circlearrowleft$  (circular path)

11. The picture shows “displacement as a function of location along a string”

What is the wavelength (“ $\lambda$ ”)?

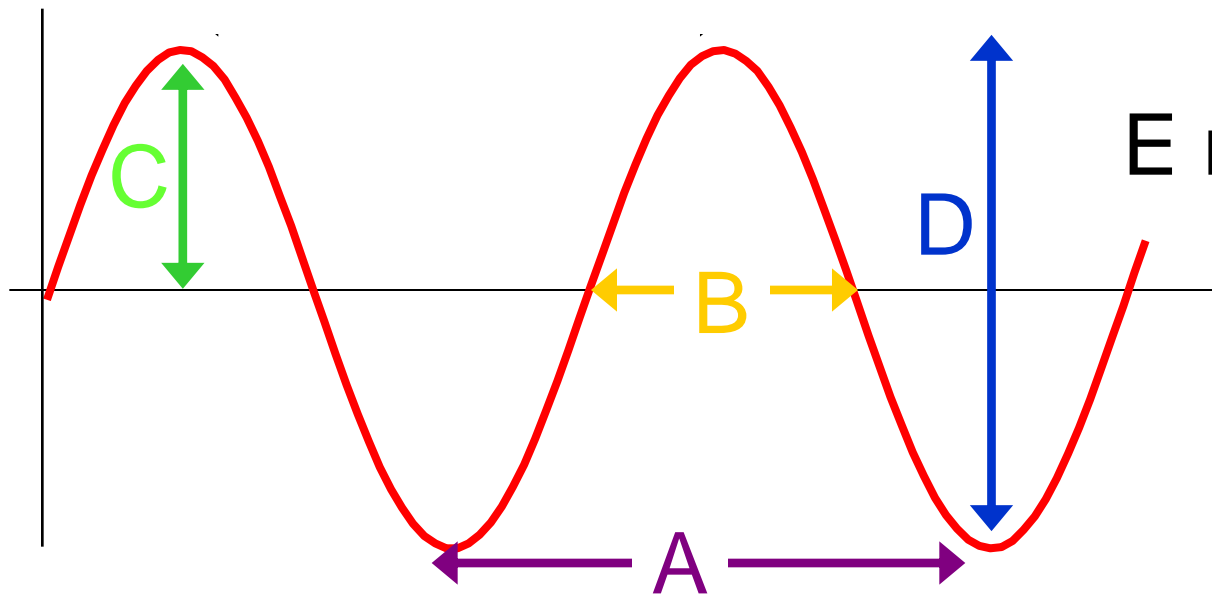

E none of these

Remember X axis is **position**  
not time

12. The picture shows “displacement as a function of location along a string”

What is the amplitude?

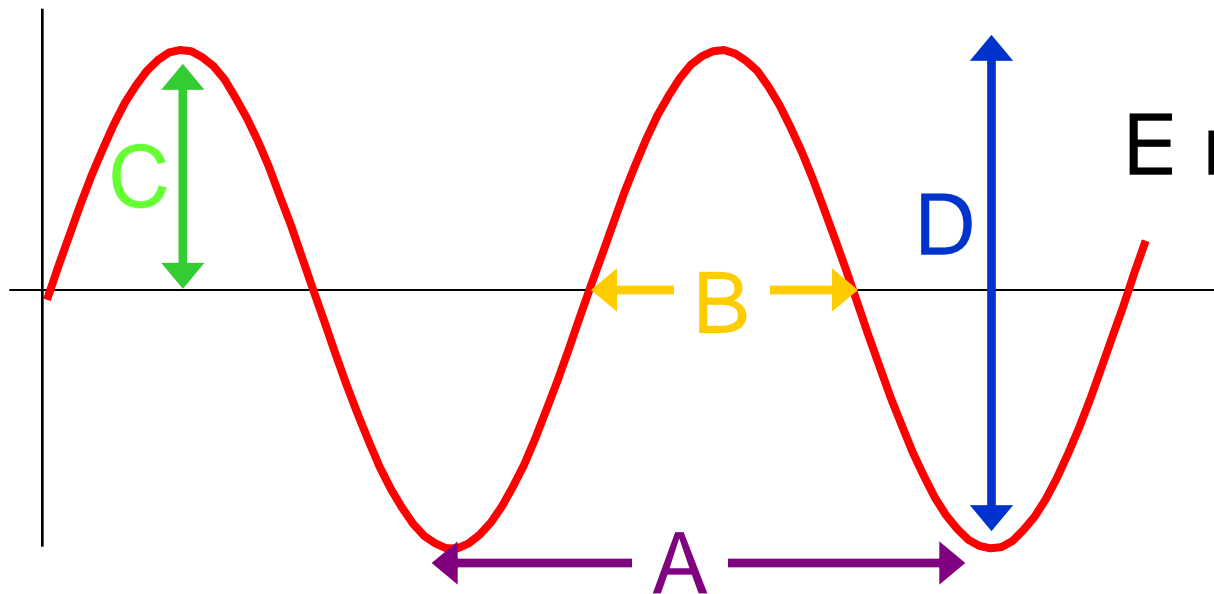

E none of these

Remember X axis is **position**  
not time

13. Looking at the following waveform, what is the period? assume it repeats itself over and over

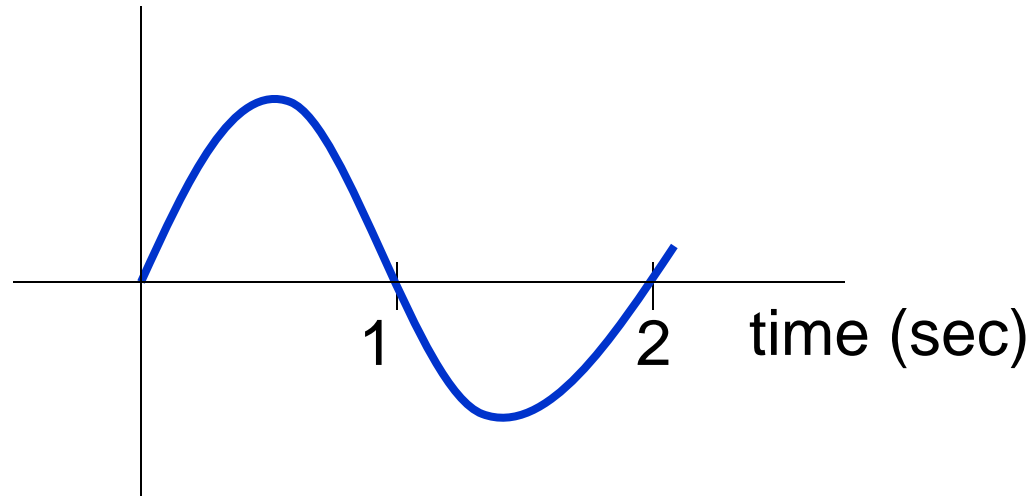

- A. 1 sec
- B. 2 sec
- C. 1 m/s
- D. 2 m/s
- E. Not enough information

14 Looking at that same wave,  
what is its speed?

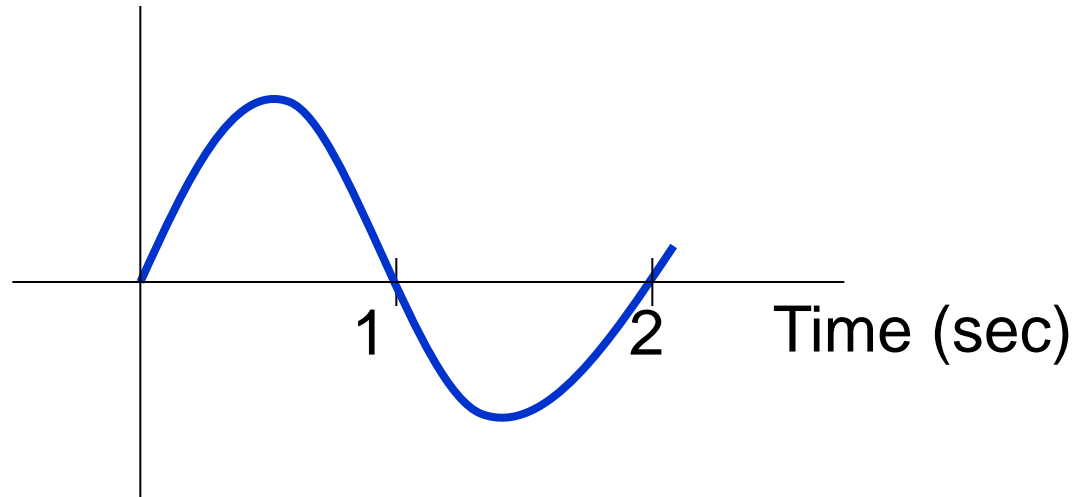

A.  $1/2$  m/s

B. 2 m/s

C. 5 m/s

D. 20 m/s

E. Not enough information

15 The wavelength,  $\lambda$ , is 10 m. What is the speed of this wave?

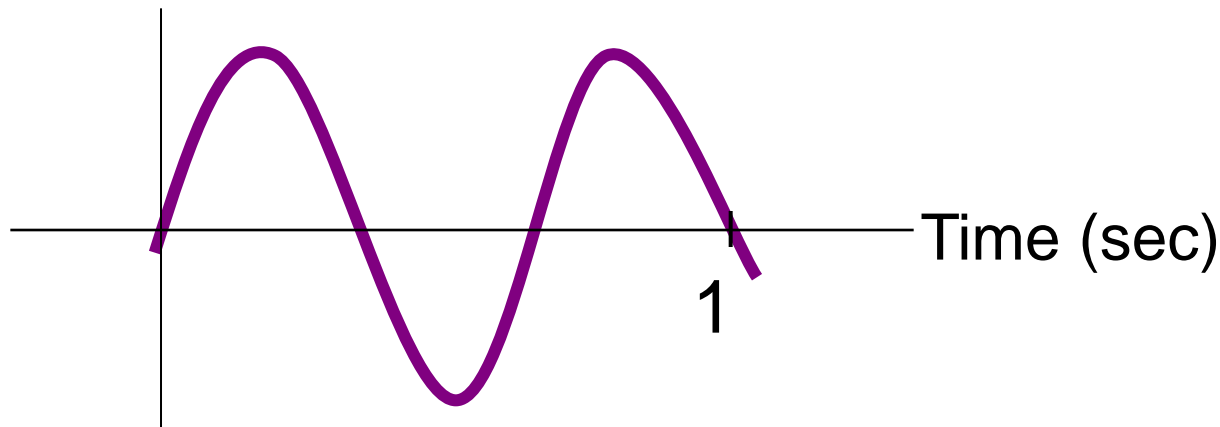

- A) 1 m/s
- B) just under 7 m/s
- C) 10 m/s
- D) 15 m/s
- E) None of the above/not enough info/not sure

16 What is the period of this wave?

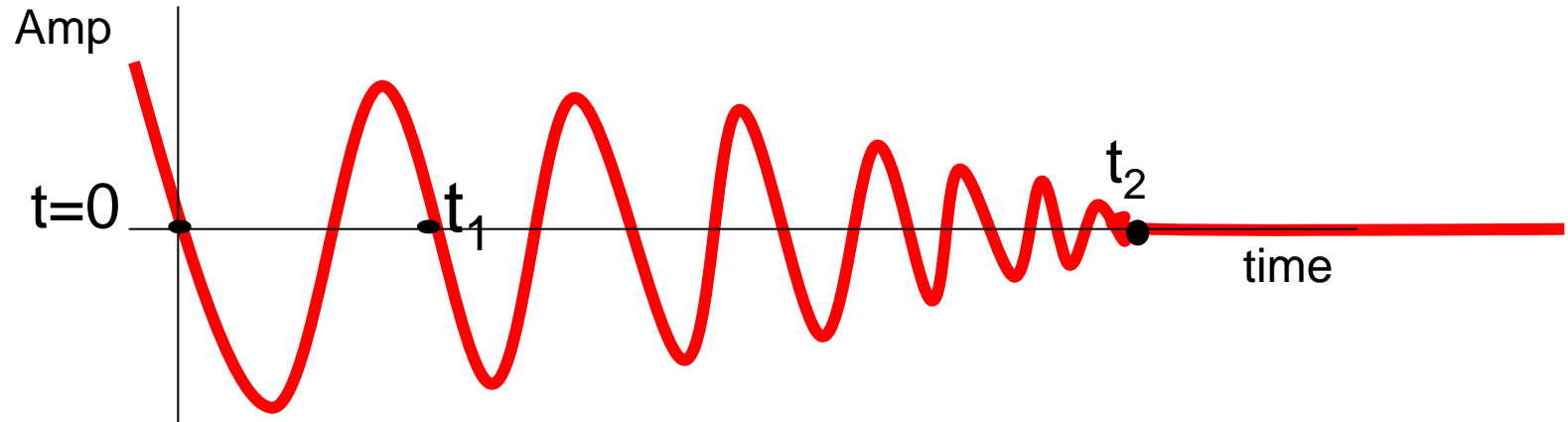

- a)  $t_1$
- b)  $t_2$
- c) Not at all defined
- d) Not well defined, but  $t_1$  is the best answer
- e) Not well defined, but  $t_2$  is the best answer

17 What is the period of this wave?

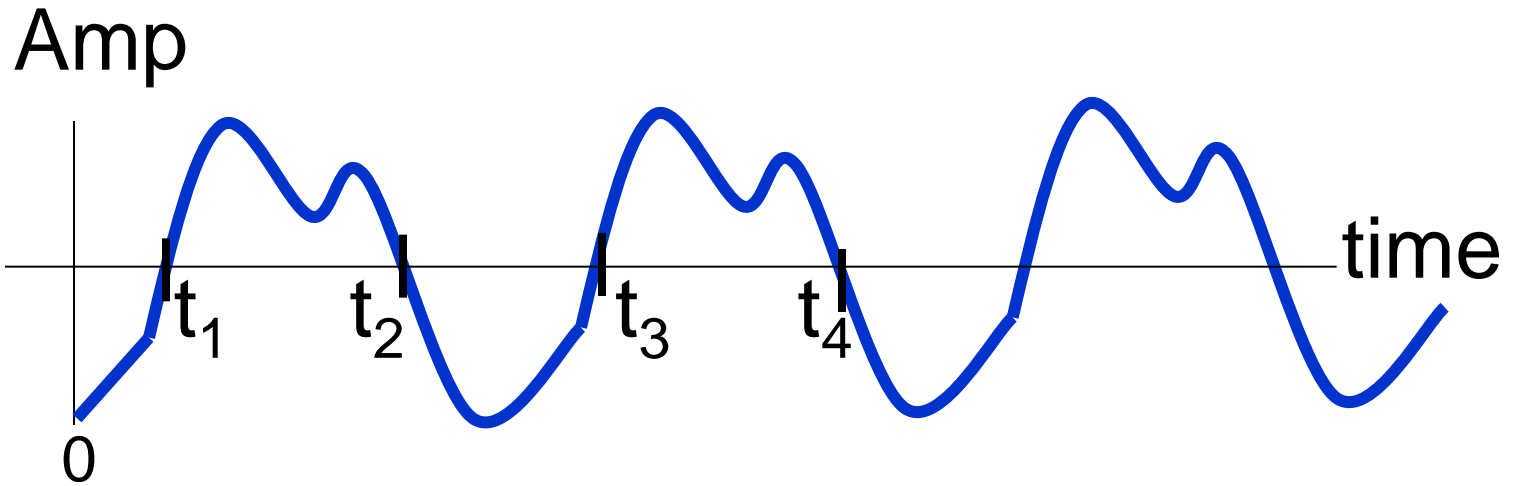

- a)  $t_1$
- b)  $t_2$
- c)  $t_2 - t_1$
- d)  $t_3 - t_1$
- e) None of the above



18 Which one of the following is most likely to be *impossible*?

- A. Transverse waves in a **gas**
- B. Longitudinal waves in a **gas**
- C. Transverse waves in a **solid**
- D. Longitudinal waves in a **solid**
- E. They all seem perfectly possible

19. To increase the volume of a tone at 400 Hz heard by the listener, the speaker must oscillate back and forth more times each second than it does to produce the tone with lower volume.

A. True    B. False

In the following graph we have plotted the pressure measured at the listener's ear as a function of time for a 200 Hz tone generated by the speaker.

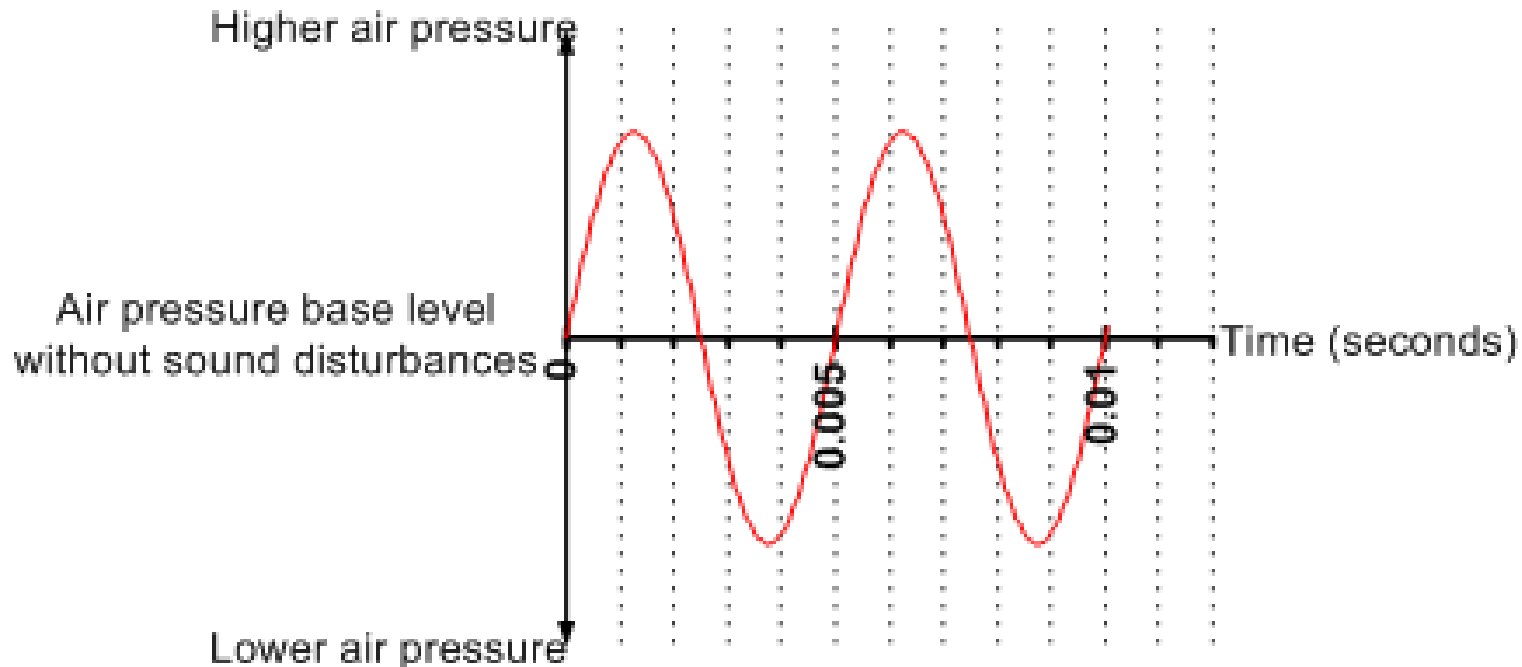

20. Which of the blue solid curves could represent the curve for a lower pitch ?

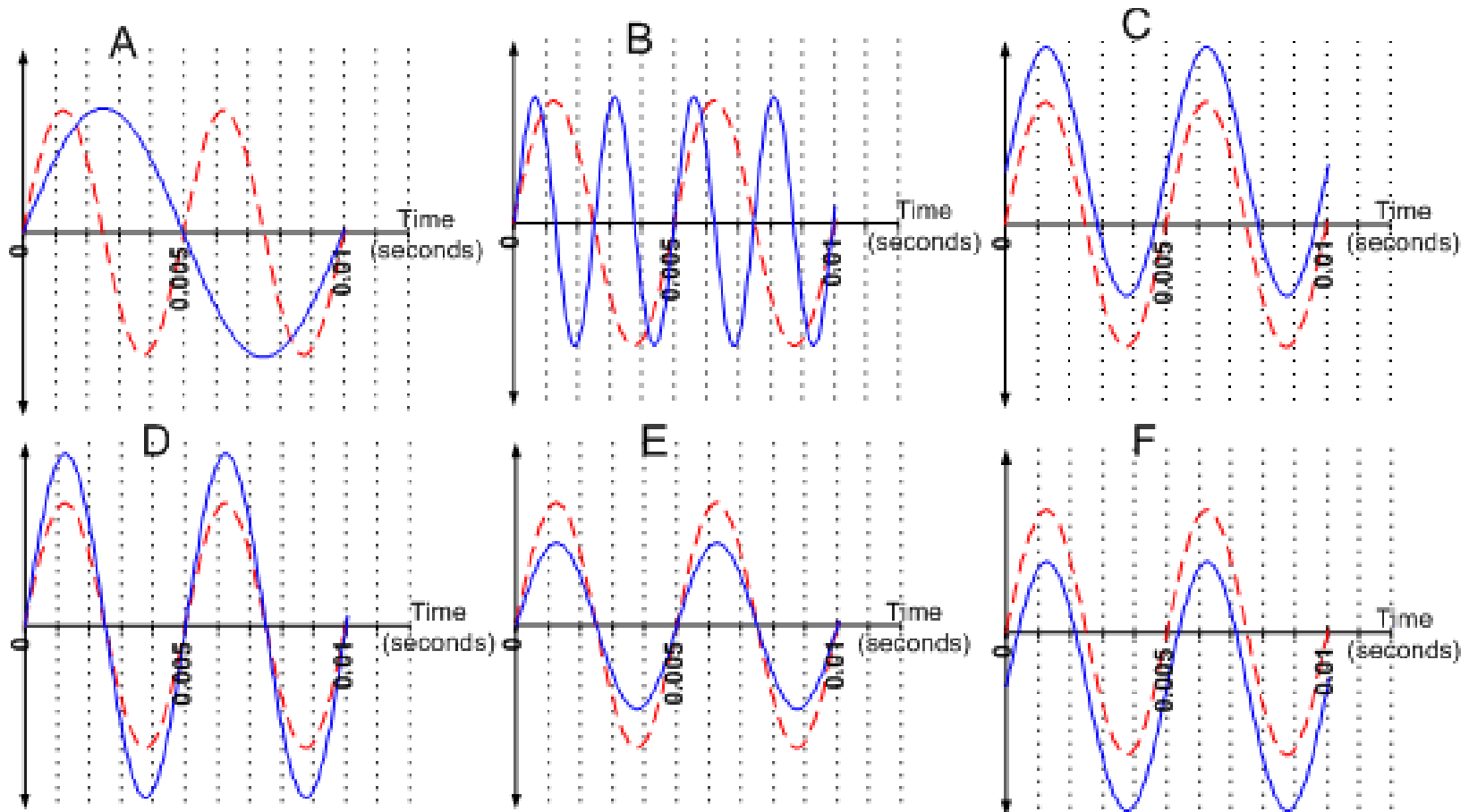

21. Which of the blue curves could represent the curve for a louder volume?

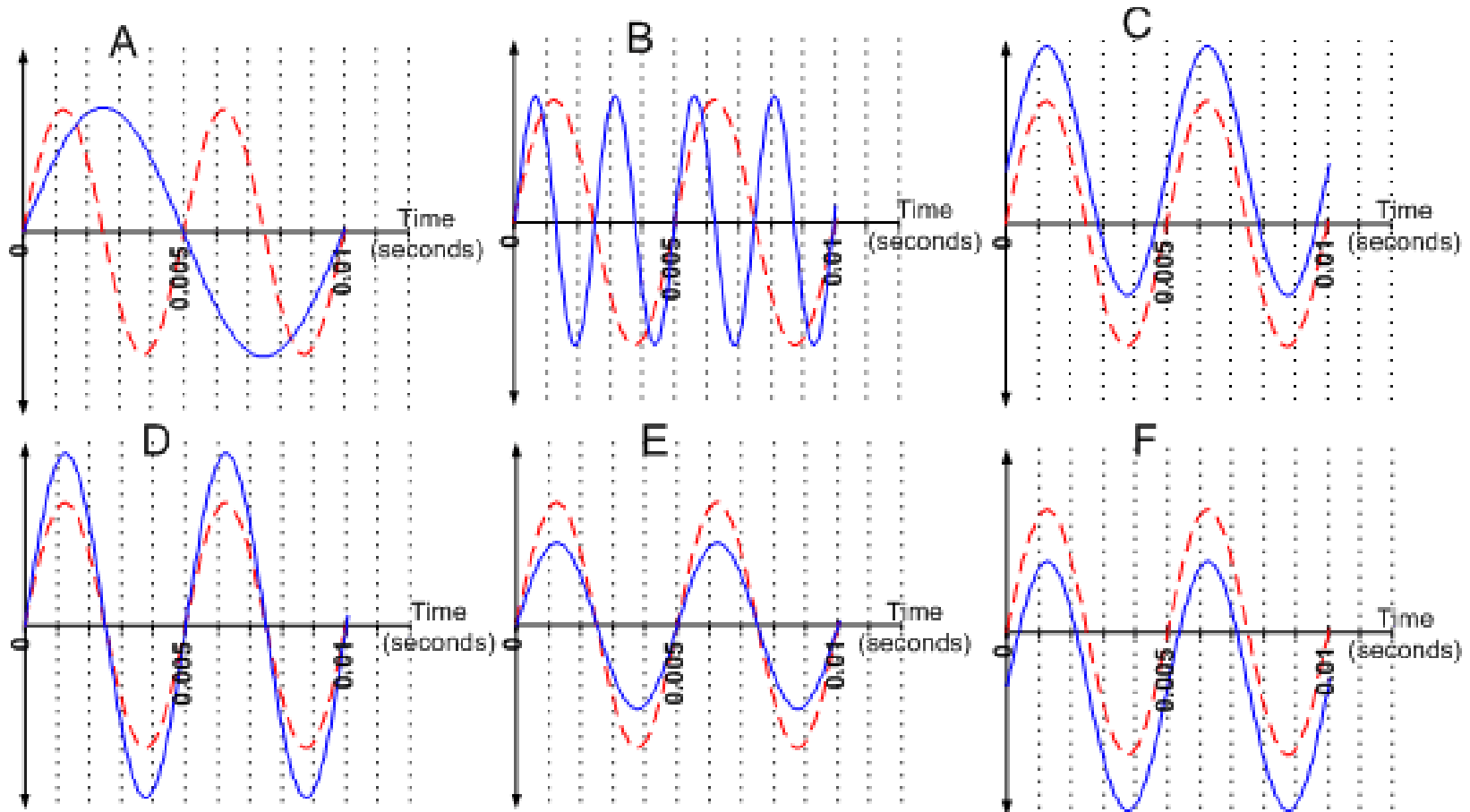

22. Which of the blue curves could represent the curve if the speaker settings are unchanged, but the listener is further?

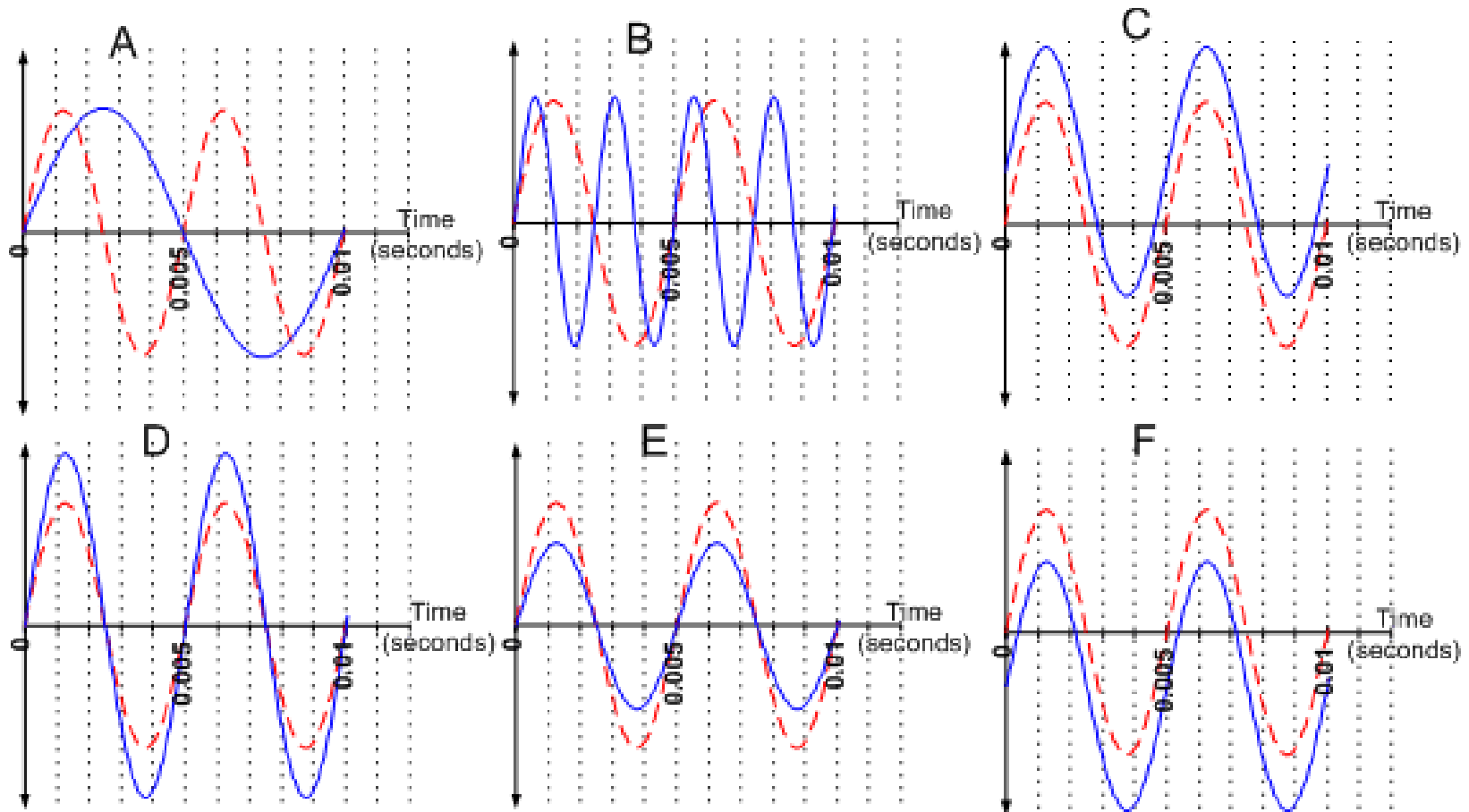

# Moving man clicker questions

Trish Loeblein [phet.colorado.edu](http://phet.colorado.edu)

Learning goals: Students will be able to accurately interpret and draw position, velocity and acceleration graphs for common situations and explain their reasoning.

1. Below is a graph of a ball's motion. Which of the following gives the best interpretation of the ball's motion?

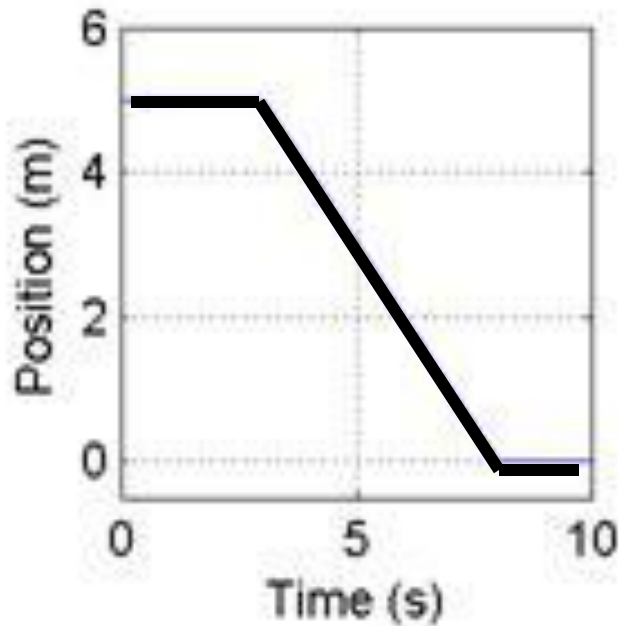



a. The ball moves along a flat surface. Then it moves forward down a hill, and then finally stops.

b. The ball doesn't move at first. Then it moves forward down a hill and finally stops.

c. The ball is moving at constant velocity. Then it slows down and stops.

d. The ball doesn't move at first. Then it moves backwards and then finally stops.

e. The ball moves along a flat area, moves backwards down a hill and then it keeps moving.

2. Draw a *velocity-time* graph would best depict the following scenario?

A man starts at the origin, walks back slowly and steadily for 6 seconds. Then he stands still for 6 seconds, then walks forward steadily about twice as fast for 6 seconds.

2 Which velocity time graph best depicts the scenario?

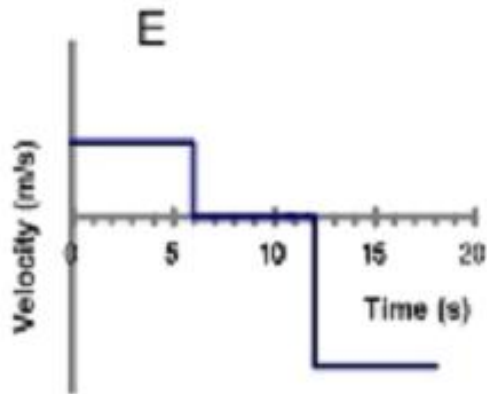
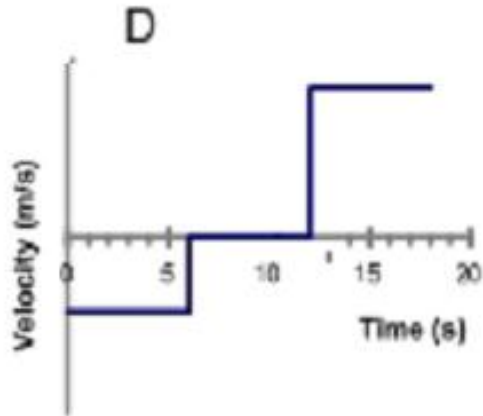
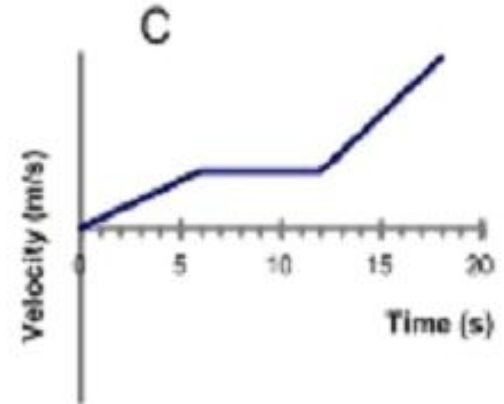
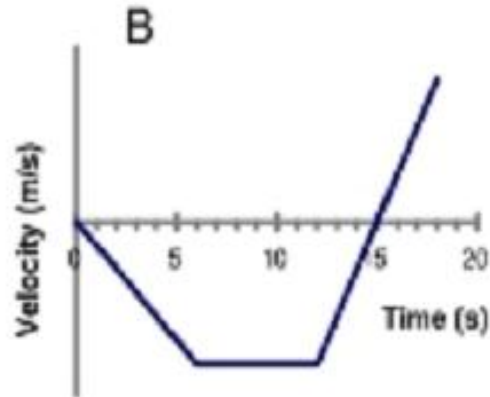
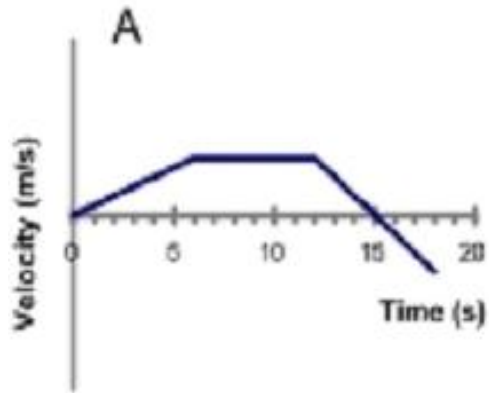

3. For the same scenario as # 2, which *position-time* graph best depicts the motion?

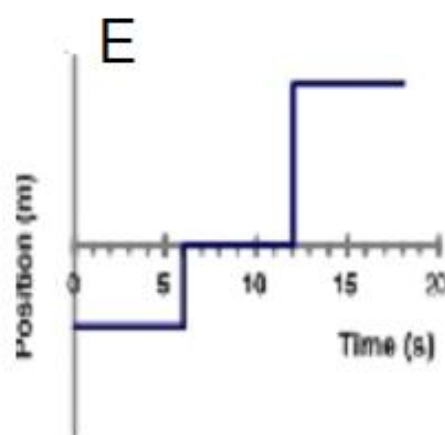
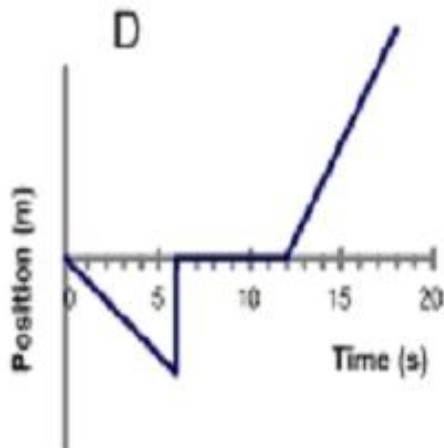
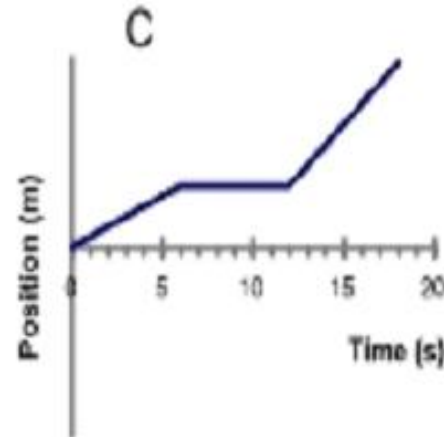
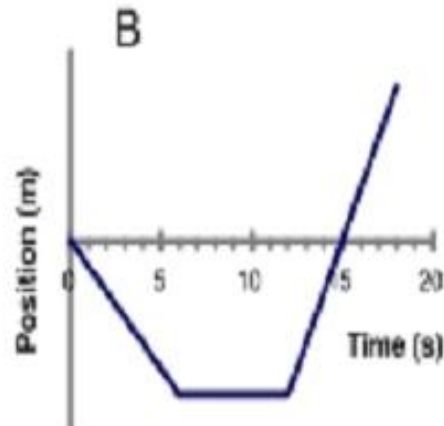
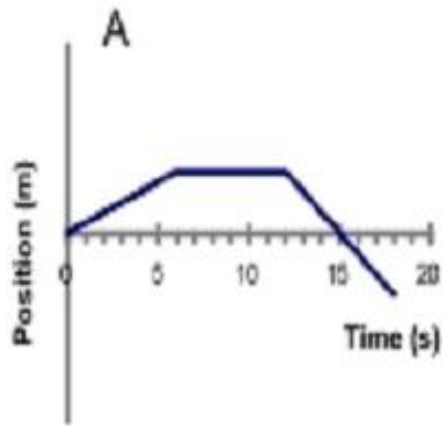

4 A car is traveling along a road. Its velocity is recorded as a function of time and is shown in the graph below.

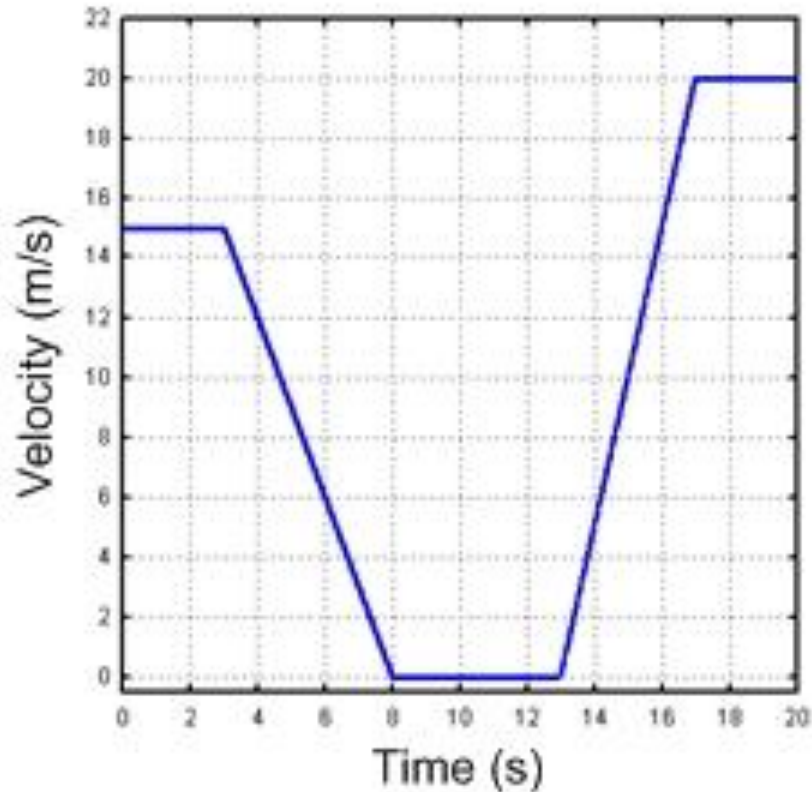

5. Which of the following ***position-time*** graphs would be consistent with the motion of

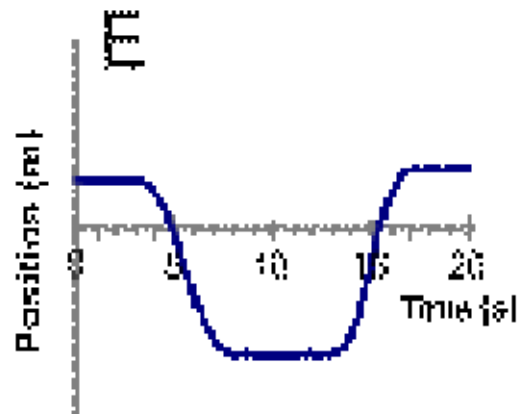
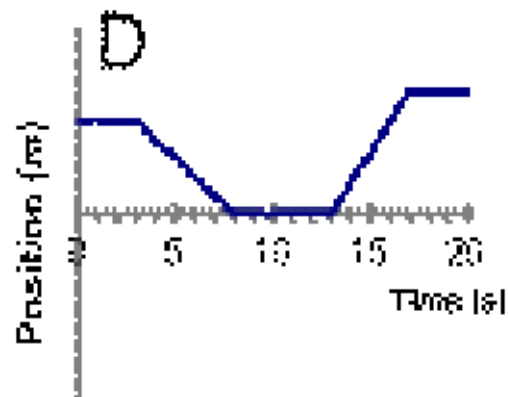
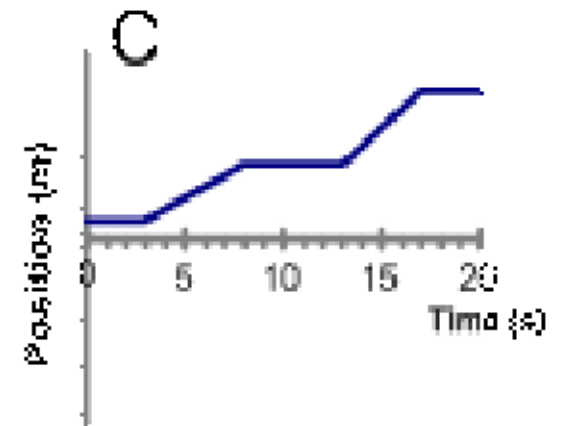
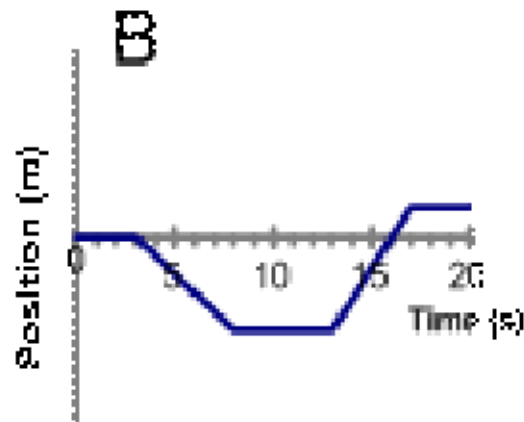
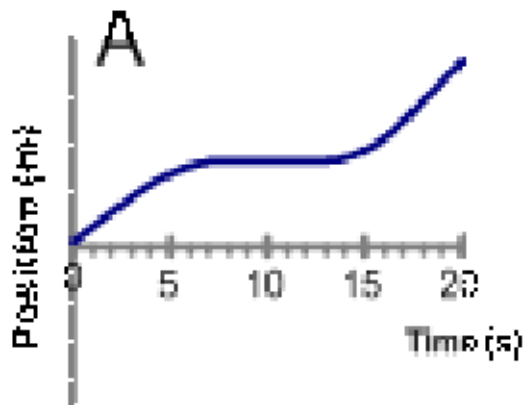

6. A car is moving forward and applying the break. Which *position-time* graph best depicts this motion?

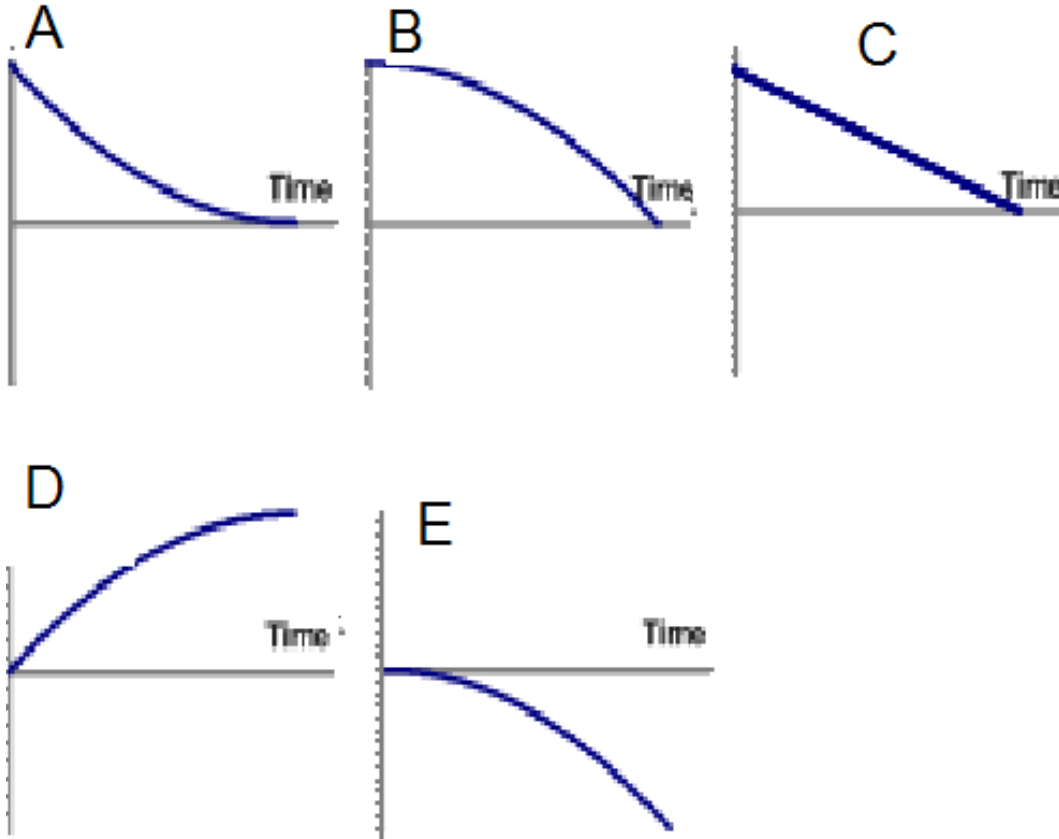

Stopping Distance. Consider two cars, a 700kg Porsche and a 600kg Honda Civic. The Porsche is speeding along at 40 m/s (mph) and the Civic is going half the speed at 20 m/s. If the two cars brake to a stop with the same constant acceleration, let's look at whether the amount of time required to come to a stop or the distance traveled prior to stopping is influenced by their initial velocity.



Using Moving man

Select the accelerate option and set the initial velocity, initial position, and an acceleration rate so that the walking man's motion will emulate that of the car stopping with constant acceleration.

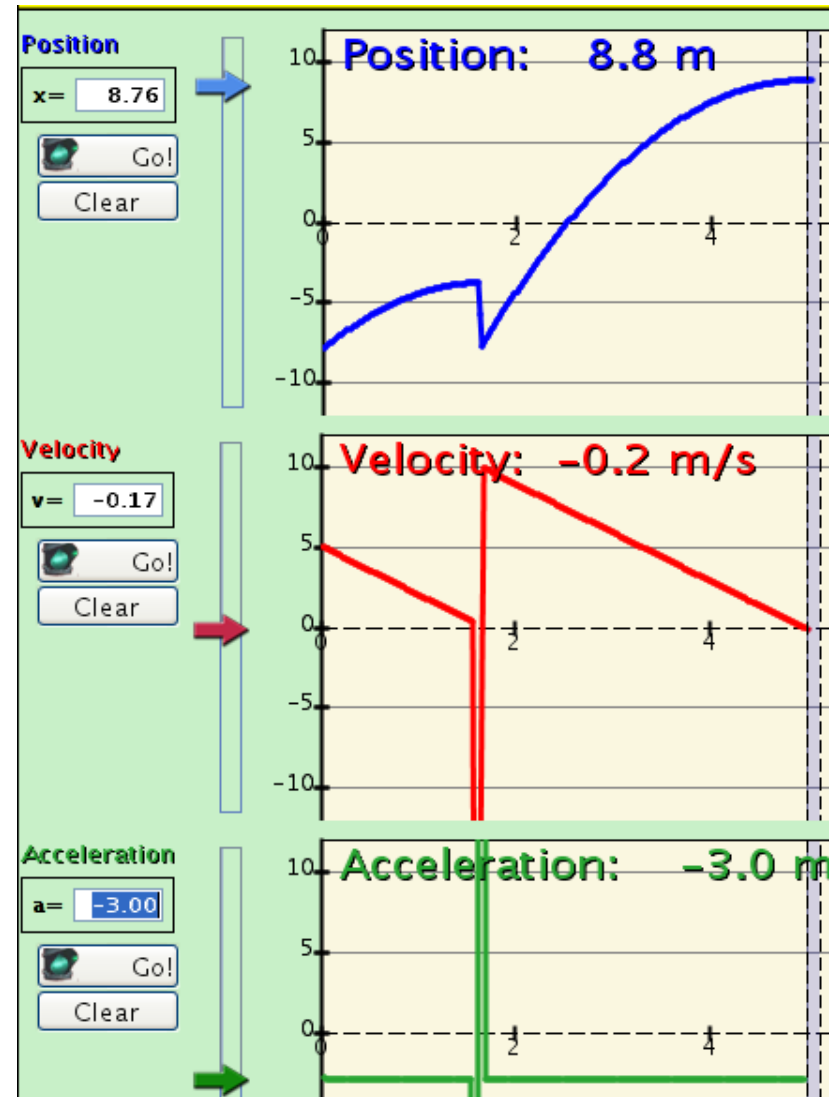

7. If you double the initial walking speed, the amount of time it takes to stop

A. is six times longer

B. is four times longer

C. is two times longer

D. does not change

E. is half as long

8. If you double the initial walking speed, the man walks ... before coming to a stop.

- Half the distance
- four times farther
- three times farther
- two times farther
- The same distance

9. If you triple the initial walking speed, the walking man goes ... before stopping.

- A. one third as far
- B. One ninth as far
- C. three times farther
- D. six times farther
- E. nine times farther

Notes from Perkins' homework

While moving man is useful to answer this question, equations give us the same result.

Use  $Velocity = Initial\ velocity + acceleration \times time$   
or  $acceleration = (change\ in\ velocity)/(time\ elapsed)$   
which is the same as  $(time\ elapsed) = (change\ in\ velocity)/acceleration$ .

So it will take 2 times as long to stop if the initial velocity is 2 times larger and the acceleration is the same.

$distance\ traveled = (initial\ velocity) \times time + (1/2 \times acceleration \times time \times time)$

10. If the acceleration is zero, the man must be standing still.

A. True

B. False

11. Velocity and acceleration are always the same sign (both positive or both negative).

A. True

B. False

12. If the speed is increasing, the acceleration must be positive.

A. True

B. False



## Notes from Perkins' homework

A negative acceleration indicates that the acceleration points in the negative direction. Under these conditions, if the man is moving in the positive direction, the negative acceleration will be acting to slow him down (velocity and acceleration point in opposite directions). If the man is moving in the negative direction, the negative acceleration will be acting to speed him up (velocity and acceleration point in the same direction).

# Lady Bug: Rotational and Circular motion

**Learning Goals** Students will be able to:

1. Explain the kinematics' variables for rotational motion by describing the motion of a bug on a turntable. The variables are:
  - Angular displacement, speed, and acceleration
  - Arc length
  - Tangential speed
  - Centripetal and tangential acceleration
2. Describe how the bug's position on the turntable affects these variables.

# Lady bug activity directions:

In this activity, you must include values that you measure **and** show sample calculations to support your answers to the questions. Include examples that use both bugs in different locations.

Sample calculations include:

Equation:  $PE = mgh$

Substitution:  $PE = .50 * 9.81 * 2$

Answer with units: 9.81 J

1. A bug is spinning on a platform with constant speed, what was the direction of acceleration at the blue point?

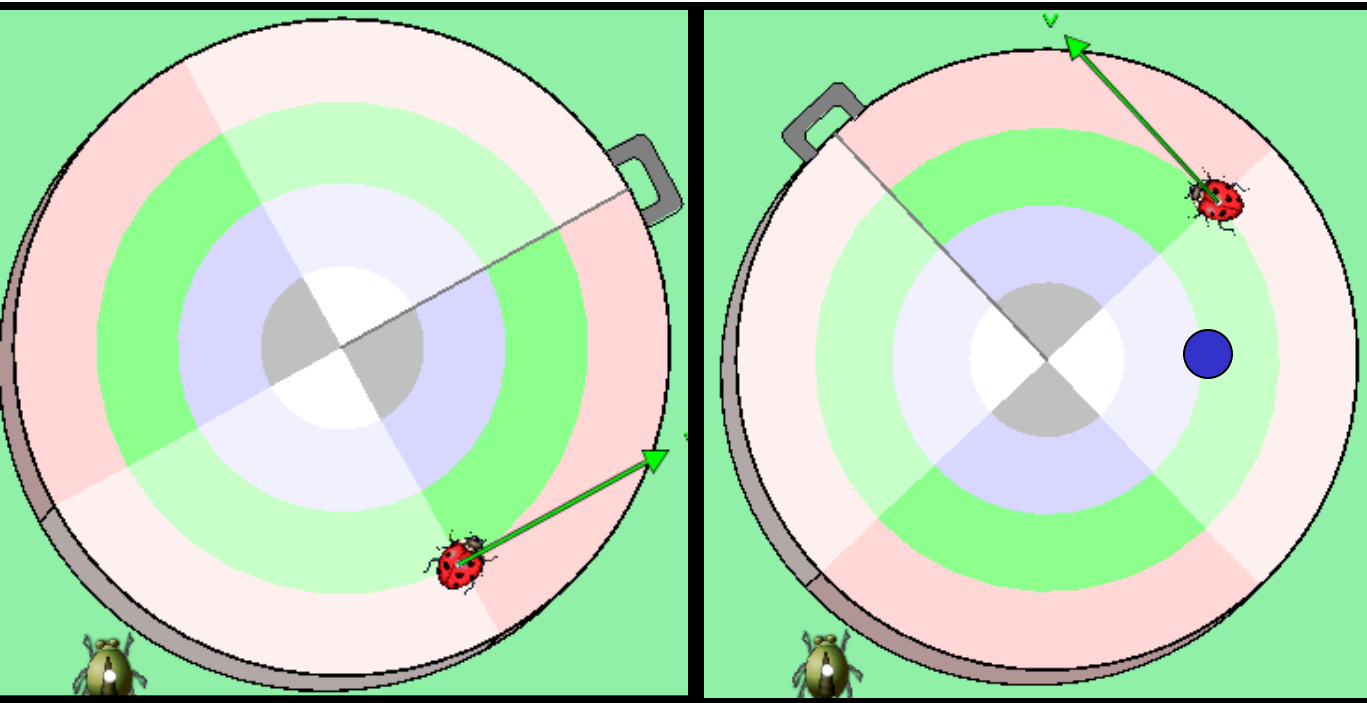

Beginning of test

End of test

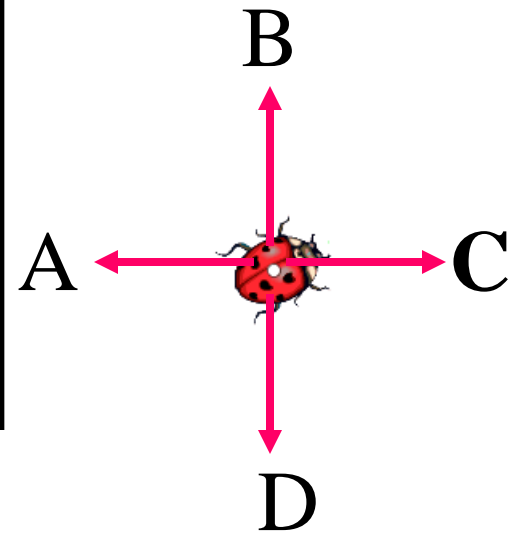

E none of these

Velocity is the green vector

Answer to previous slide

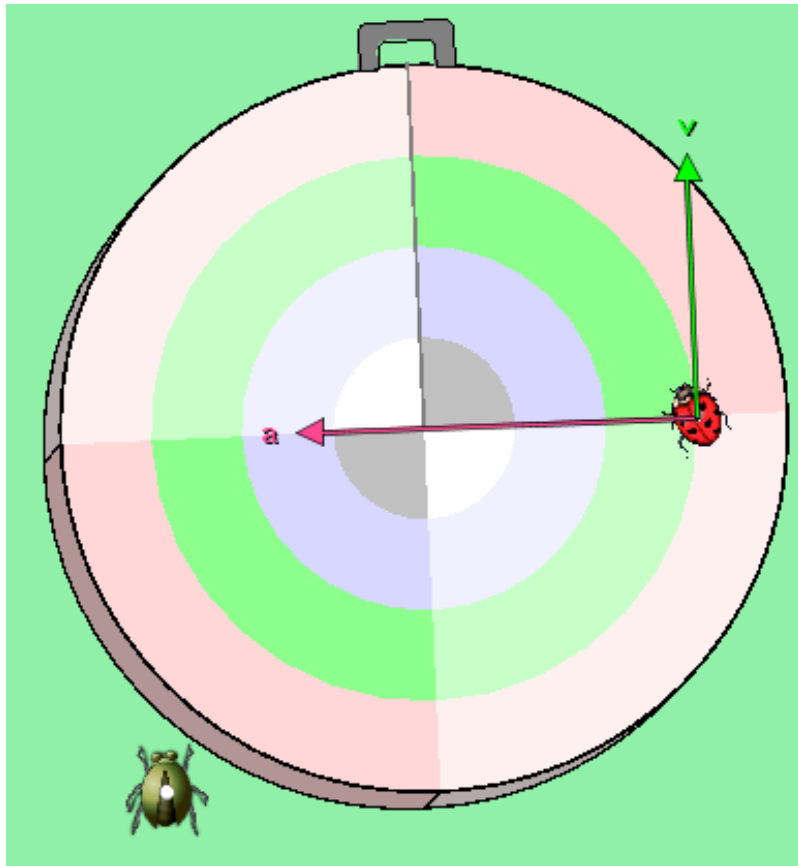

**A: acceleration vector**  
always points radially  
for constant speed

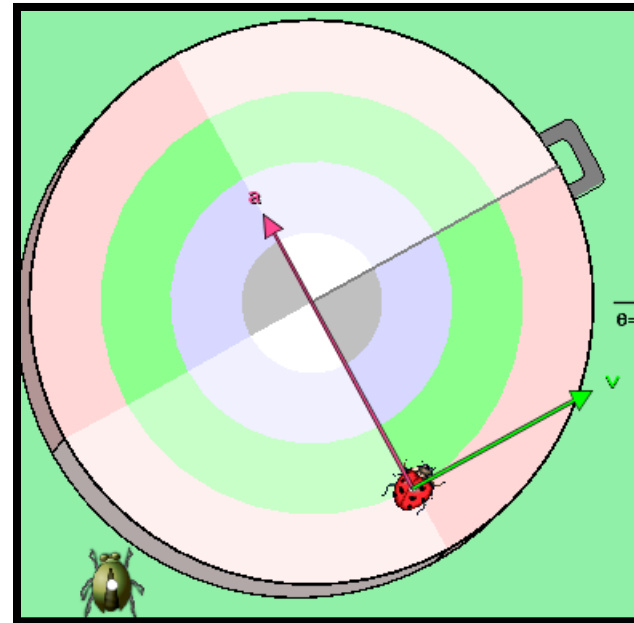

Beginning  
of test

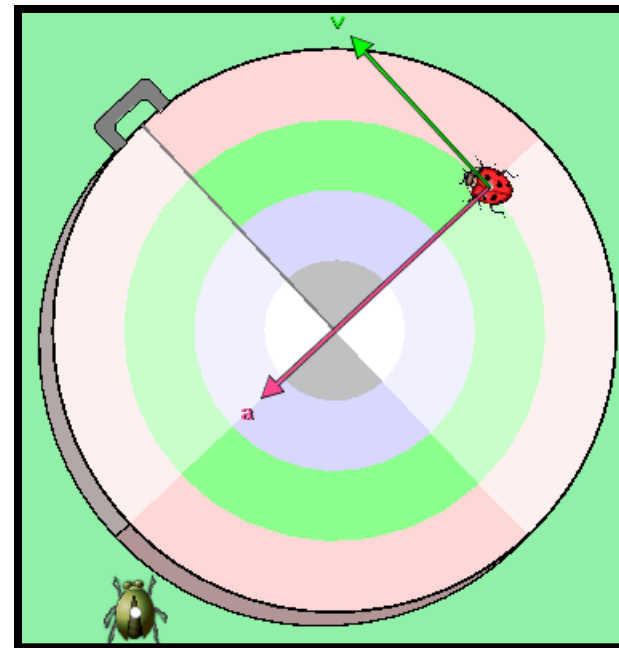

End of test

**CTCirc-1.** A particle is moving along the path shown, with constant speed. Its velocity vector at two different times is shown. What is the direction of the acceleration when the particle is at point X?

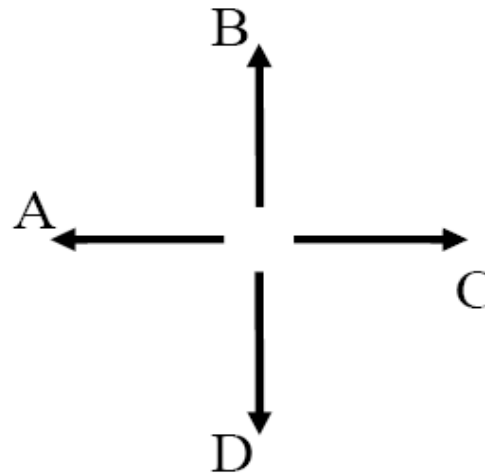
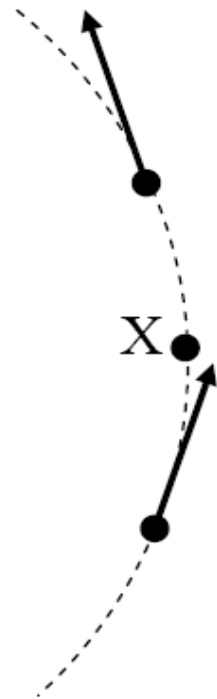

(E) None of these

Answer: to the left (A)

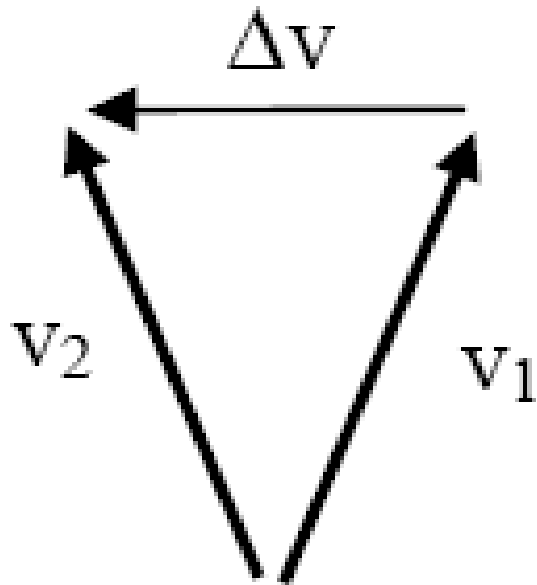



2. A bug is on a platform spinning clockwise & speeding up. Which best shows the bug's acceleration direction at this spot?

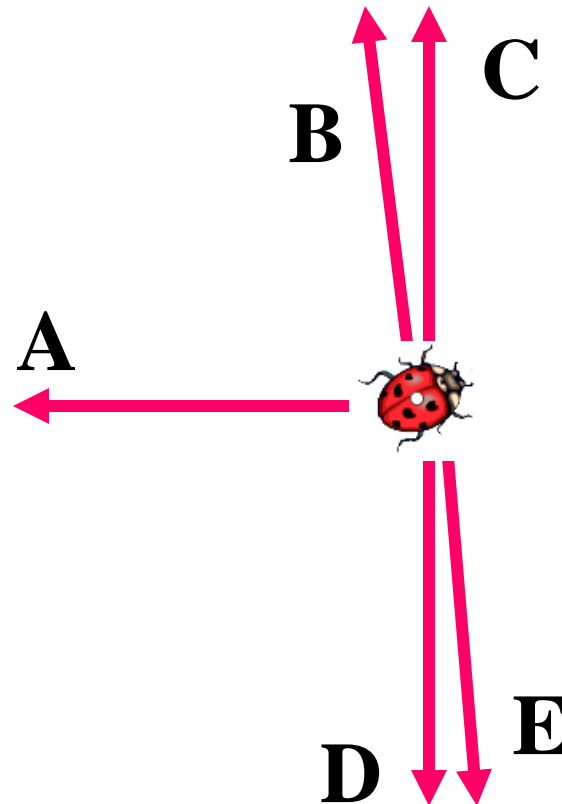
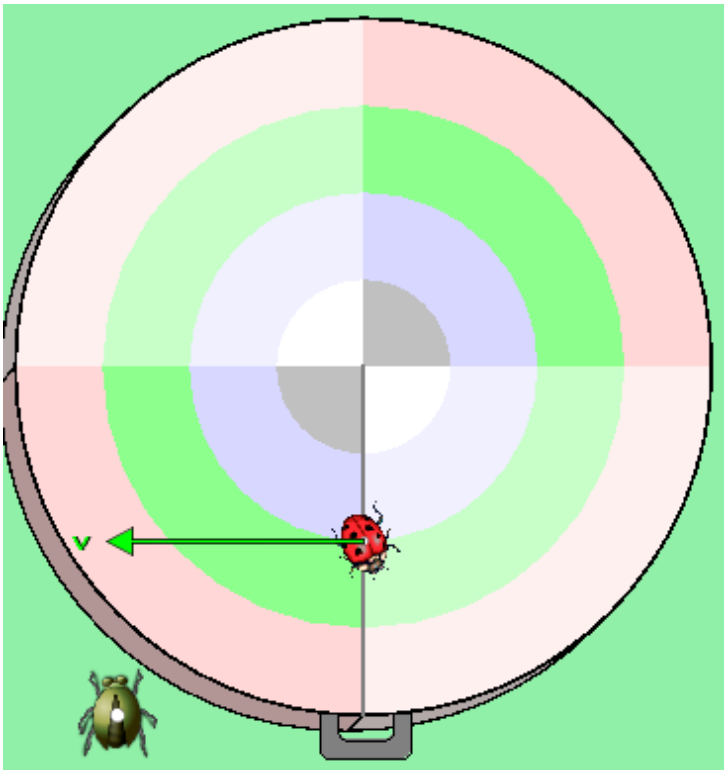

Answer to previous slide

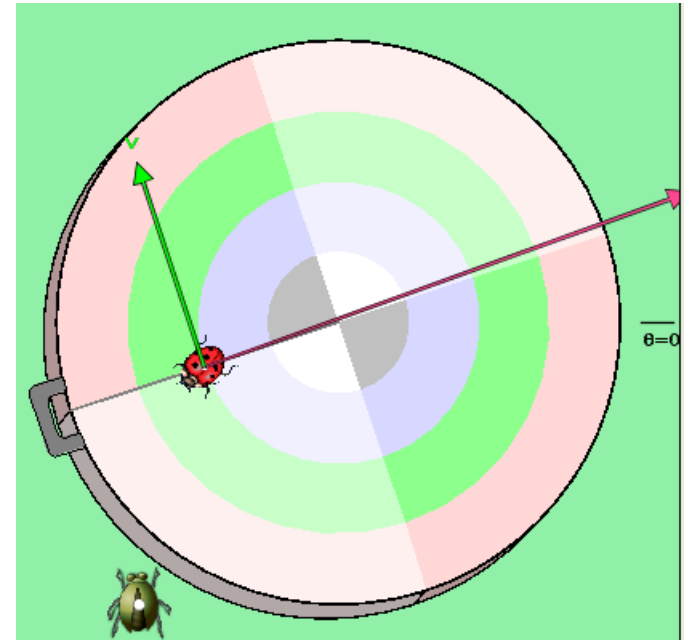
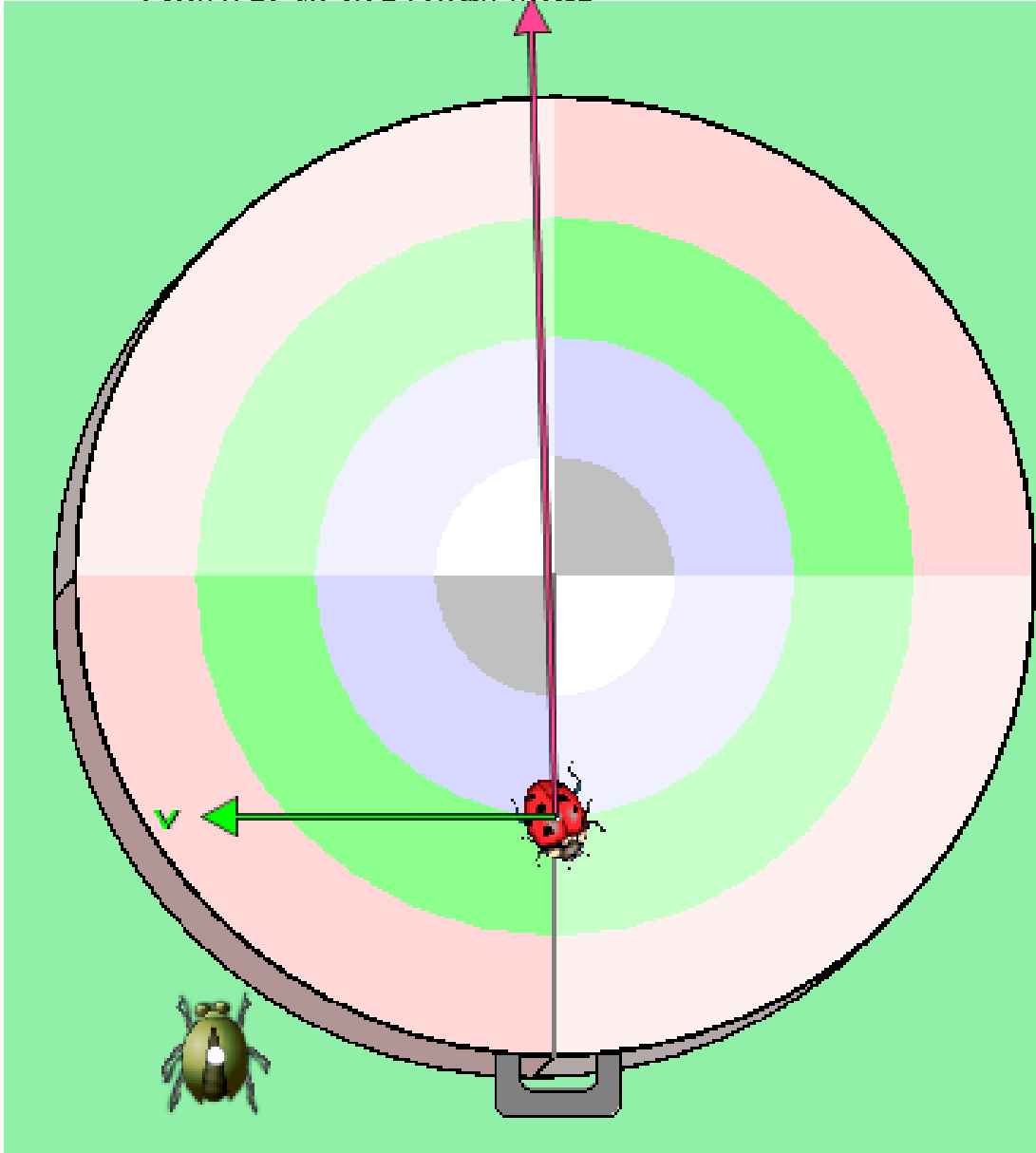

B: If the acceleration is constant and increasing, the vector will be not radial, but off to the same side of the radius as the velocity vector.

**CTRot-3.** A ladybug is clinging to the rim of a spinning wheel which is spinning CCW and is speeding up. At the moment shown, when the bug is at the far right, what is the approximate direction of the ladybug's acceleration?

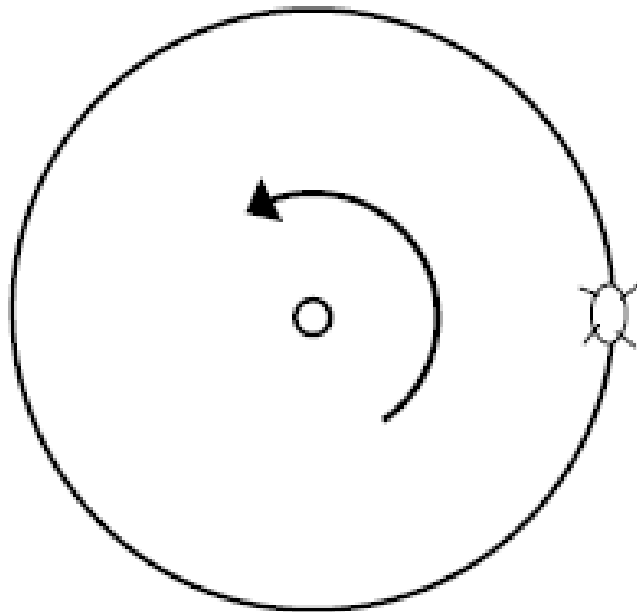

- A) ↙
- B) ↑
- C) →
- D) ←
- E) ↘

# Ctr rot 3 ans E

**Answer:**



The direction of the acceleration  $\mathbf{a}$  is the same as the direction of  $\Delta\mathbf{v}$ . The  $\mathbf{v}_1$ - $\mathbf{v}_2$ - $\Delta\mathbf{v}$  diagram looks like:

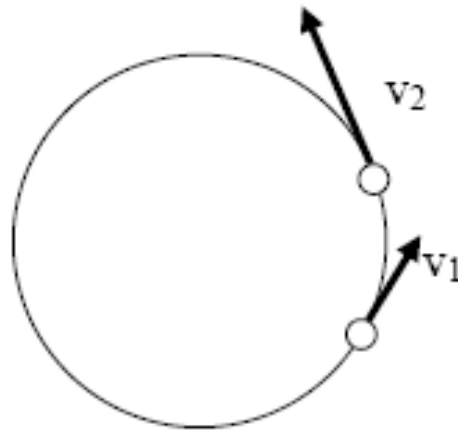
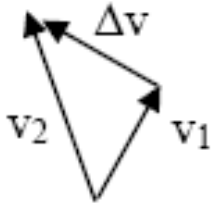

# 3

**CTRot-1.** A pocket watch and Big Ben are both keeping perfect time. Which minute hand has the larger angular velocity  $\omega$ ?

- A) Pocket watch's
- B) Big Ben's
- C) Same  $\omega$  on both.

Which minute hand's tip has the larger tangential velocity?

- A) Pocket watch's
- B) Big Ben's
- C) Same  $\omega$  on both.

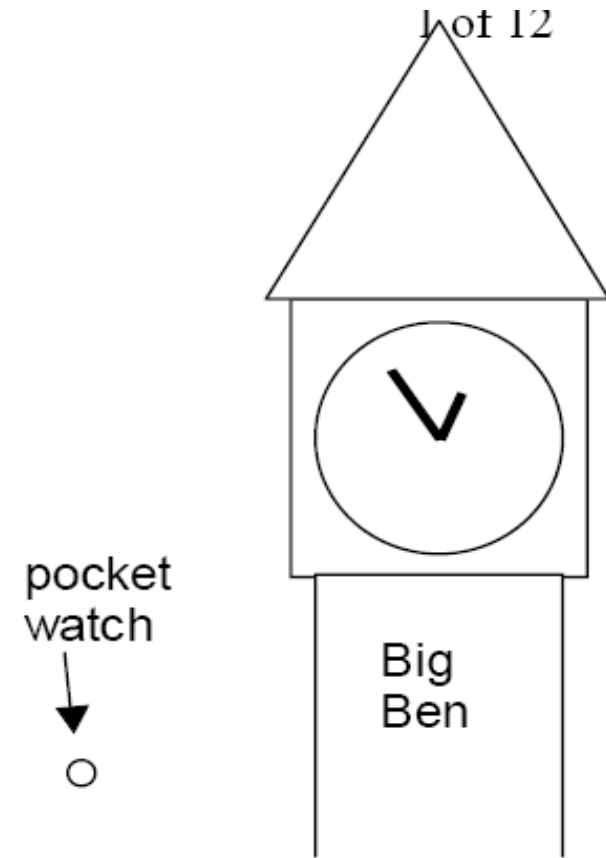

CRT rot 1 ans **C, B**

---

Answers: Both Big Ben and the pocket watch have the same magnitude angular velocity

$$|\omega| = \frac{2\pi \text{ rad}}{3600 \text{ s}}$$

Big Ben has the larger tangential velocity  $v = \omega r$ .

**Ladybug Revolution (1.05.02)**

File Options Help

Intro **Rotation**

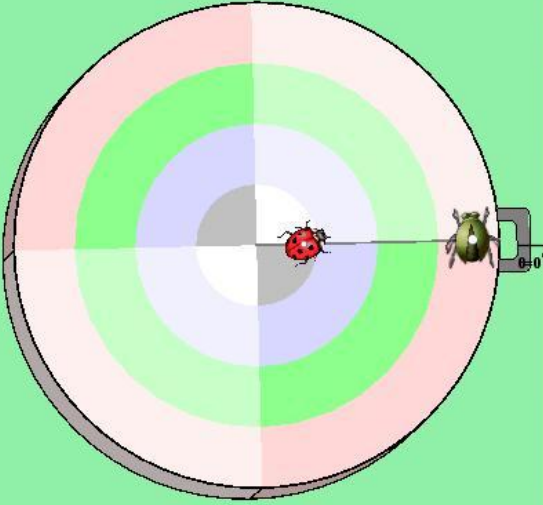

**Angle**

$\theta =$

Go! Clear

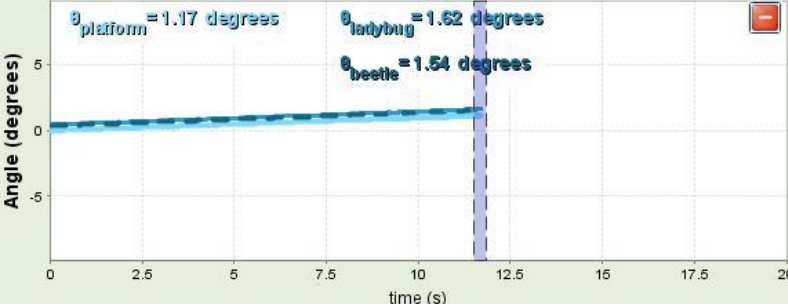

$\theta_{platform} = 1.17$  degrees  
 $\theta_{ladybug} = 1.62$  degrees  
 $\theta_{beetle} = 1.54$  degrees

**Angular Velocity**

$\omega =$

Go! Clear

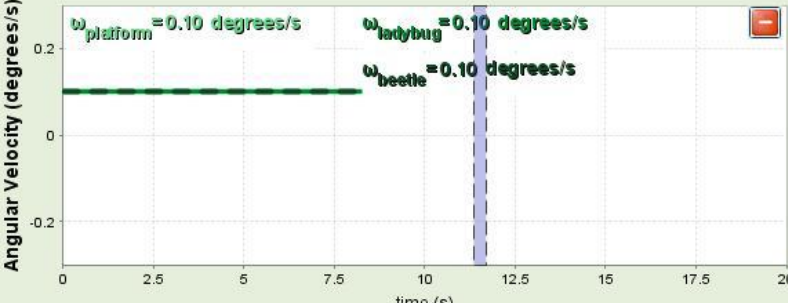

$\omega_{platform} = 0.10$  degrees/s  
 $\omega_{ladybug} = 0.10$  degrees/s  
 $\omega_{beetle} = 0.10$  degrees/s

**Velocity**

Show speed  
 Show X-Velocity  
 Show Y-Velocity

Symbol Key

Show Platform Graph  
 Show Ladybug Graph  
 Show Beetle Graph

Angle Units

degrees  
 radians

Show Velocity Vector  
 Show Acceleration Vector

Reset All

Ruler



$v_{ladybug} = 0.00$  m/s  
 $v_{beetle} = 0.01$  m/s

slow  fast

Go! Playback Step Rewind Clear

Java Application Window

4

**CTCirc-3.** A race car travels around the track shown at constant speed. Over which portion of the track is the magnitude of the acceleration the smallest? (Hint: it's a trick question!!)

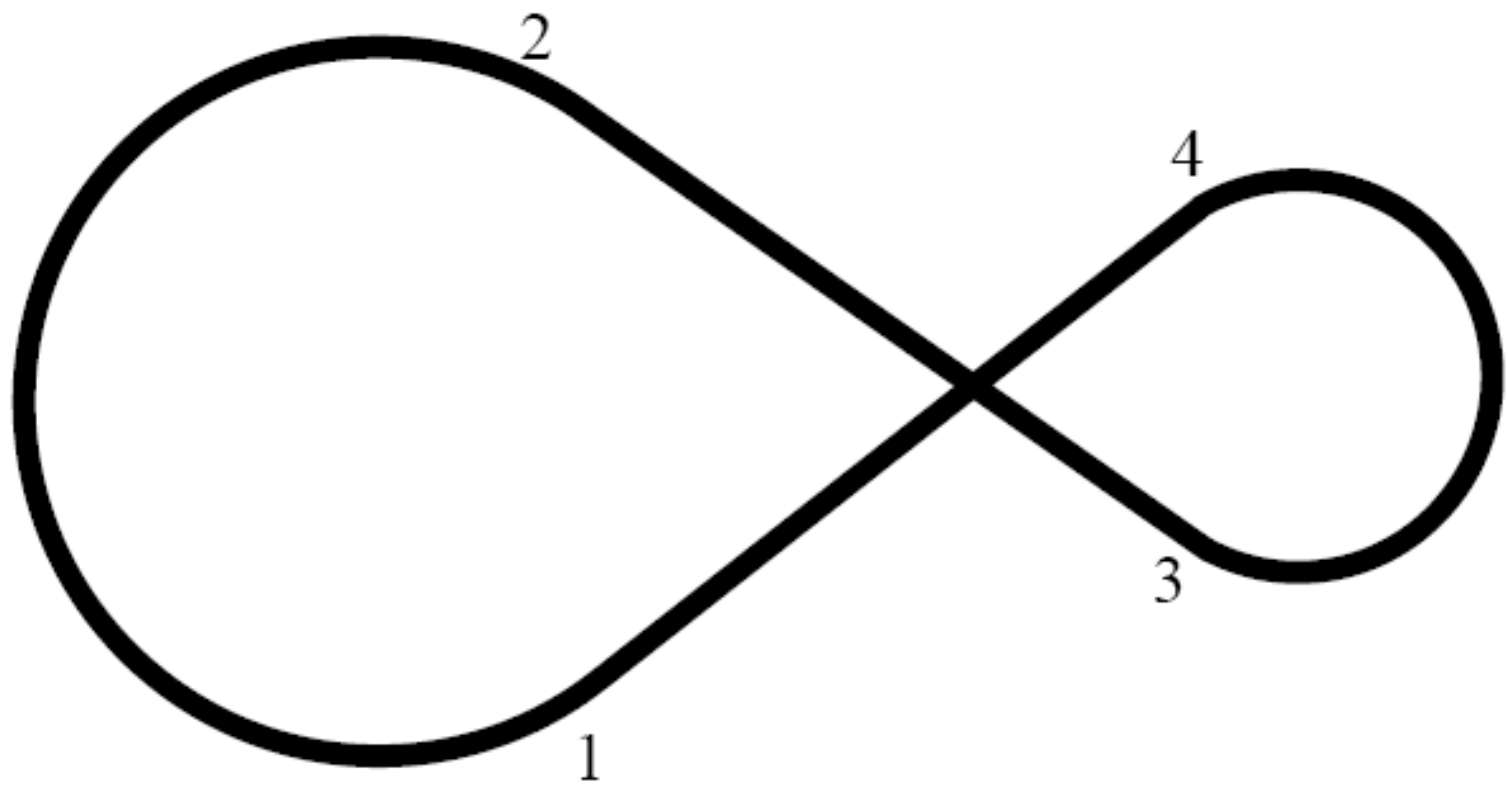

- A) From 1 to 2
- D) Both of these

B) From 3 to 4

C) Neither of these



Ct circ 3 ans c

Answer: Neither of these. The acceleration is zero along the straight line portions of the track.

# 5

**CTRot-2.** A small wheel and a large wheel are connected by a belt. The small wheel is turned at a constant angular velocity  $\omega_s$ . How does the magnitude of the angular velocity of the large wheel  $\omega_L$  compare to that of the small wheel?

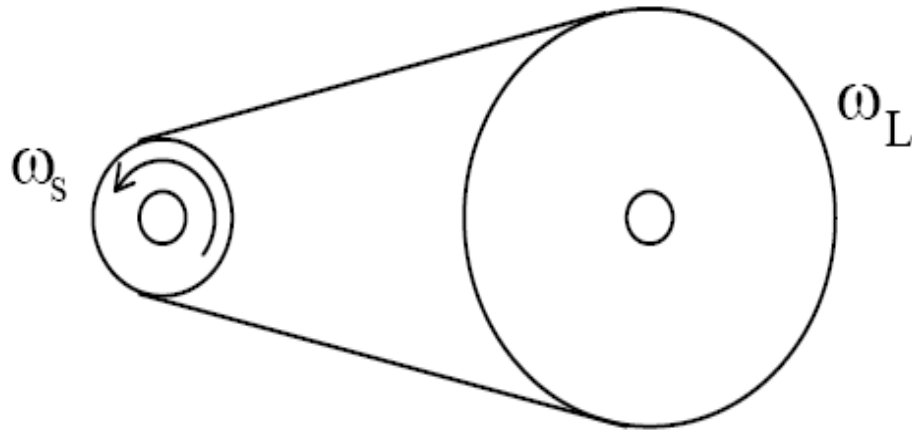

A)  $\omega_s = \omega_L$

B)  $\omega_s > \omega_L$

C)  $\omega_s < \omega_L$

There is a bug S on the rim of the small wheel and another bug L on the rim of the large wheel. How do their speeds compare?

A)  $S = L$

B)  $S > L$

C)  $S < L$

# Ctr rot 2 ans

Answers:  $\omega_s > \omega_L$  Every time the big wheel turns once, the little wheel turns several times. So the small wheel turns thru more radians per sec.

$S = L$ . Because the wheels are connected by a belt which does not slip, when one bug moves an inch along the rim, so does the other bug, so they have the same speed.

# Fourier clicker questions

## 1 Wave Representation Learning Goals:

Students will be able to think about waves as a function of time, space or space-time and explain why waves might be represented in these different ways.

## 2 Superposition of Waves Learning Goals:

Students will be able to:

- Define harmonic, determine the relationship between the harmonics,
- Explain the relationship between harmonics and the corresponding wave function.
- Predict what happens when more than one wave is present.

1. The pulse on the left is moving right, the pulse on the right is moving left. What do you see when the pulses overlap?

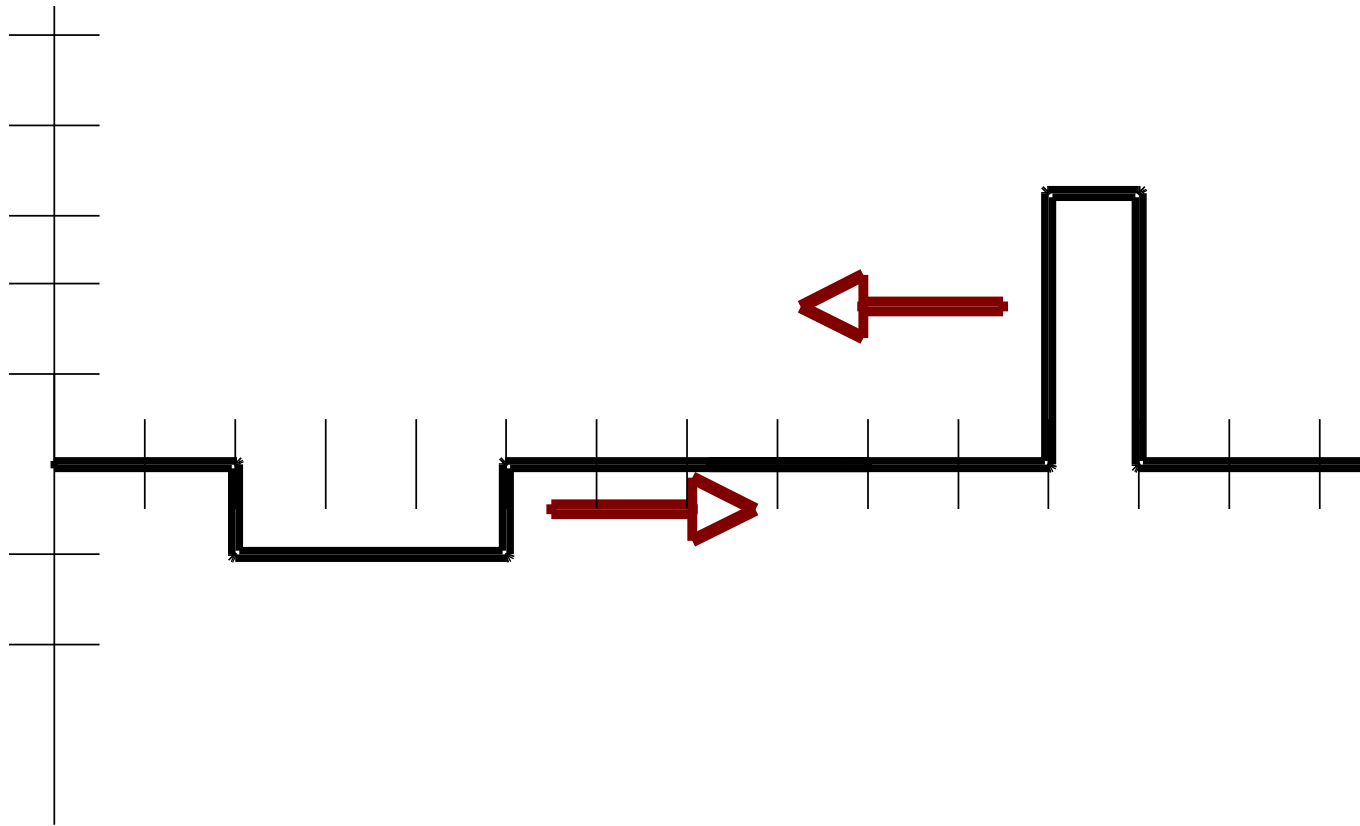

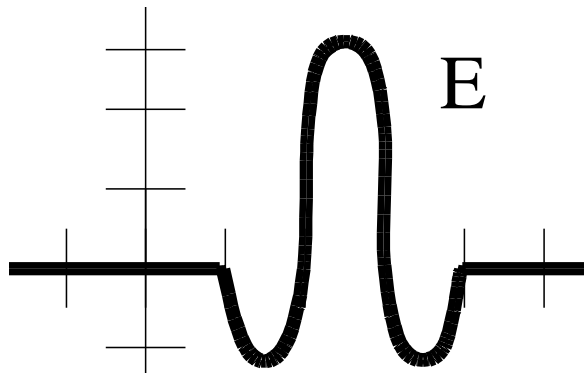
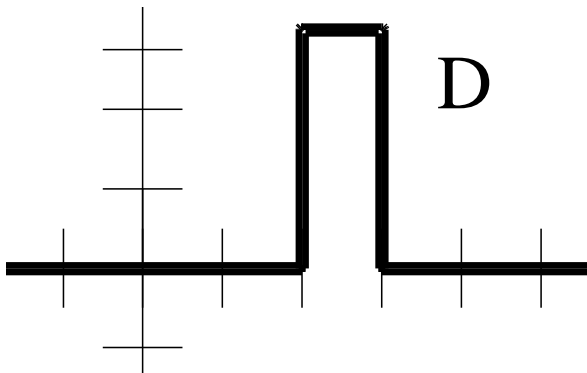
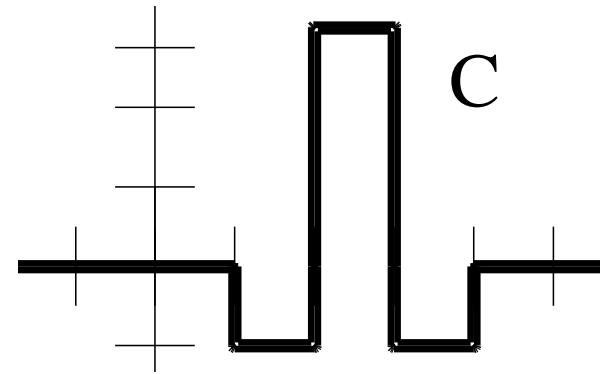
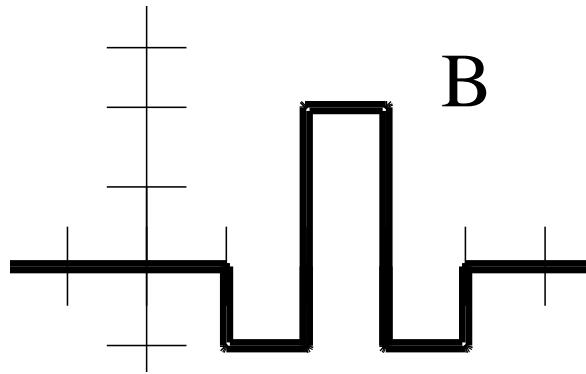
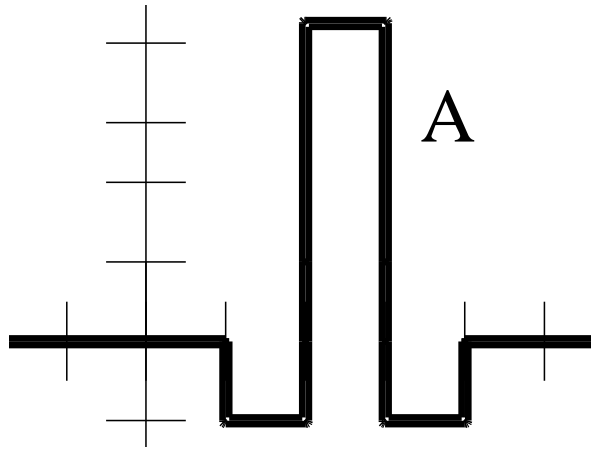
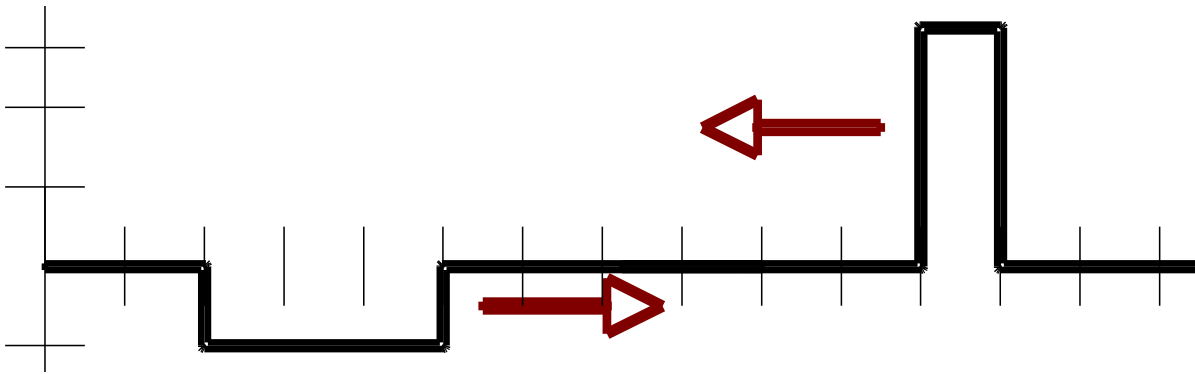

Rest of question

Adapted from CQ from Pollock University of Colorado

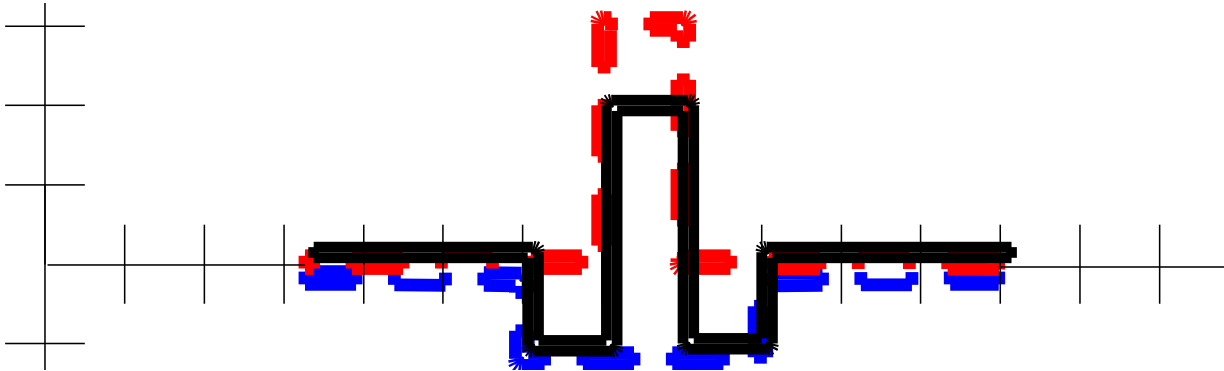
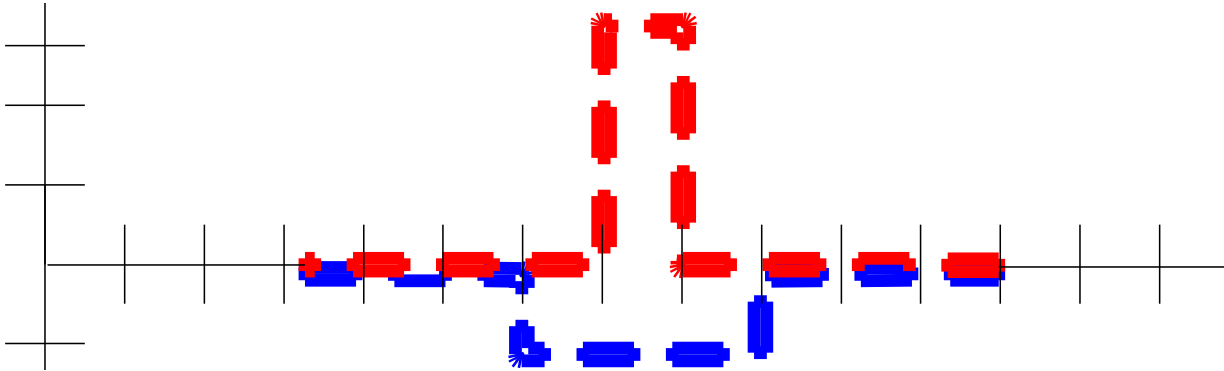
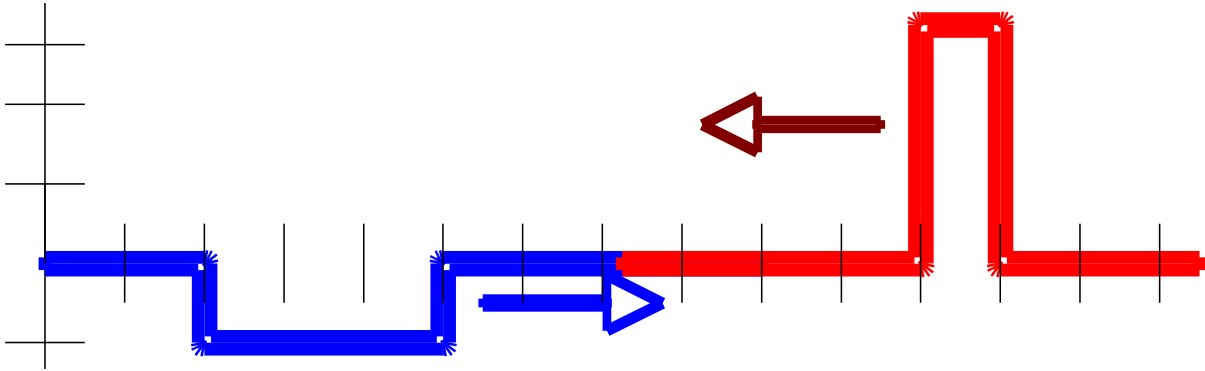

B

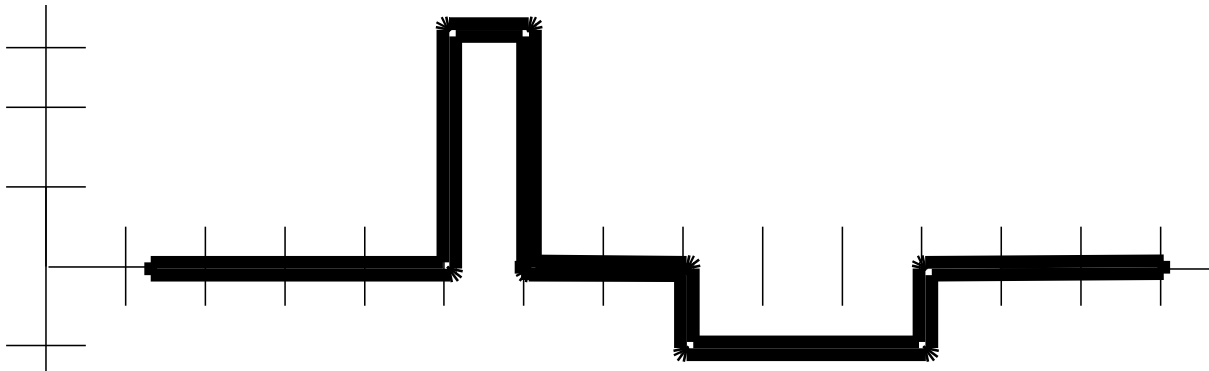
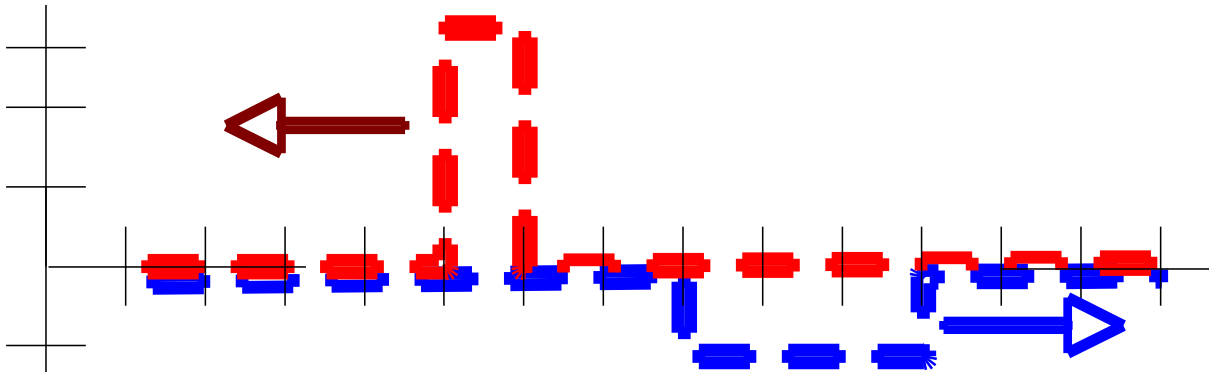
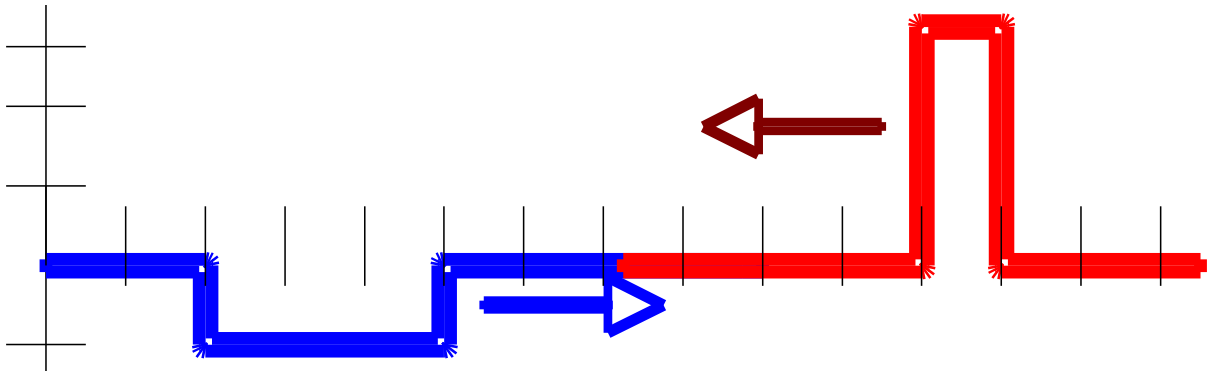

After interacting

Adapted from CQ from Pollock University of Colorado



2. If these two waves were moving through water at the same time, what would the water look like?

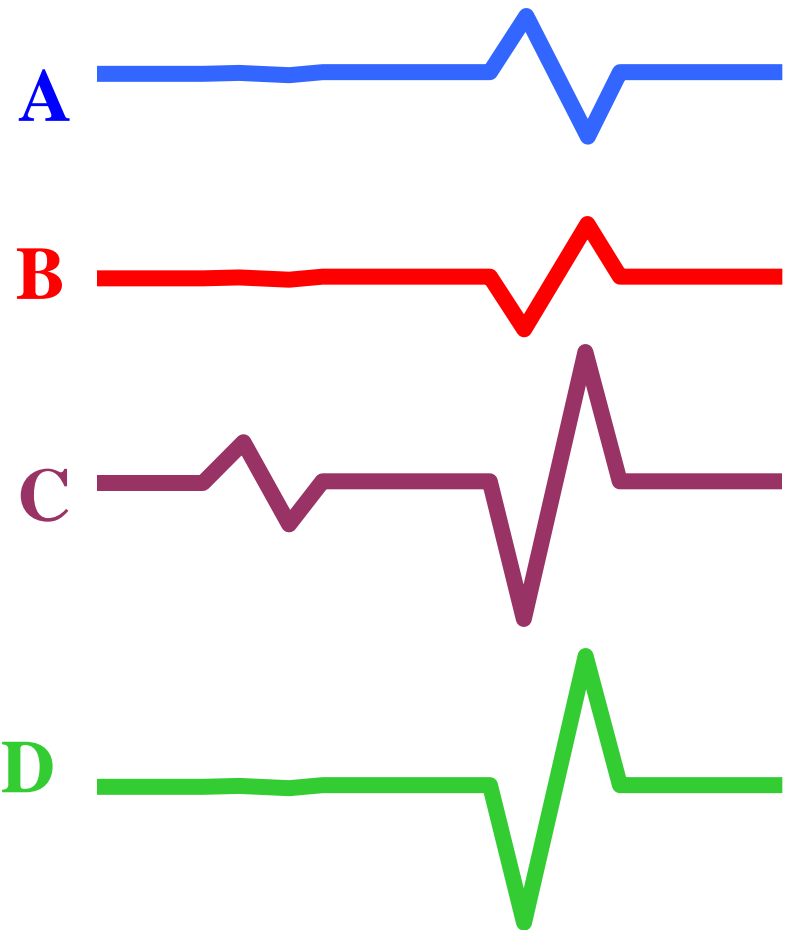
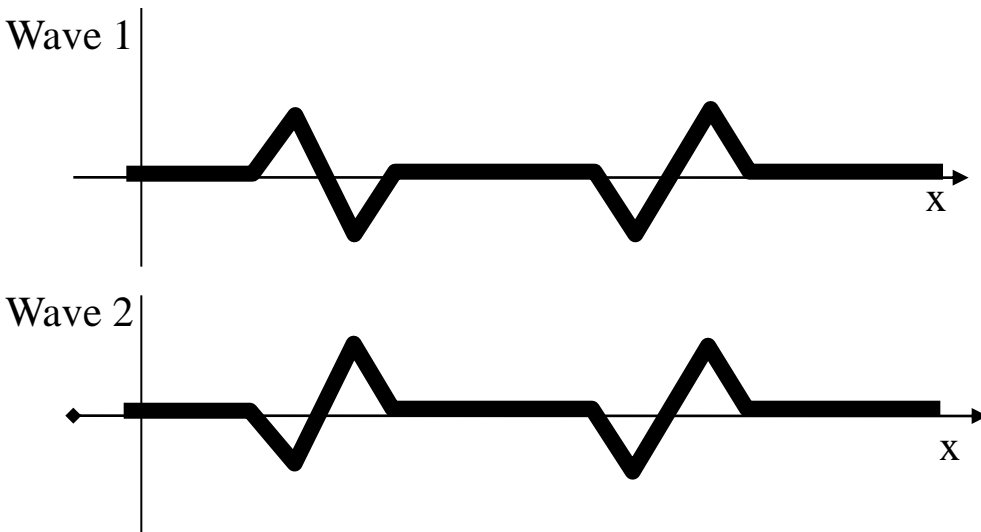

**CT-1.** At a particular instant of time, wave 1 and wave 2 are as shown. What does the sum of the two waves look like?  $f_{\text{total}}$

$$= f_1 + f_2$$

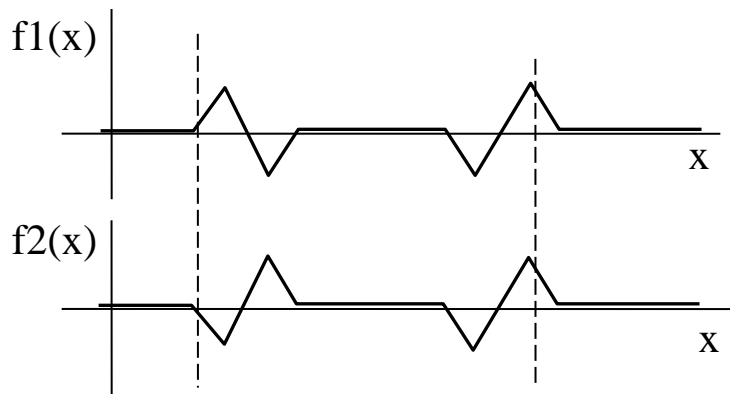

- A)
- B)
- C)
- D)

# Clicker questions for Ramp- Force and Motion [activity 1](#)

If you want to make questions like I have where only one variable changes and you see what changes on the diagram: Play with the sim until you get a diagram you like. (you can go past the spot) **Pause** the sim. Use the vertical bar to go back to a spot that you liked, then you can change variables (hit enter to make the change take place) and the changes will show on the diagram without having to run the sim.

1. If the free body diagram for Betty pushing her file cabinet is:  
What will happen?

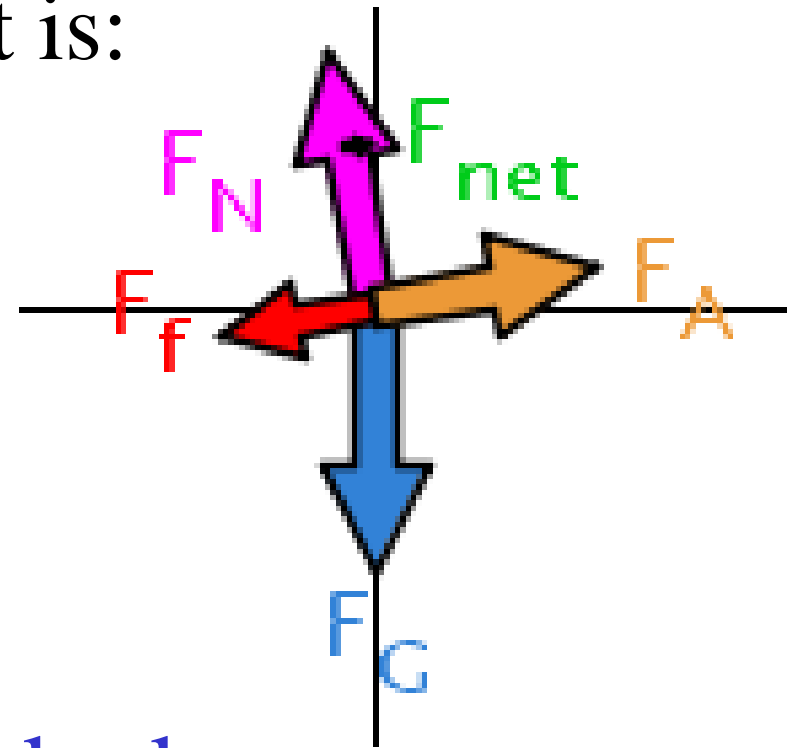
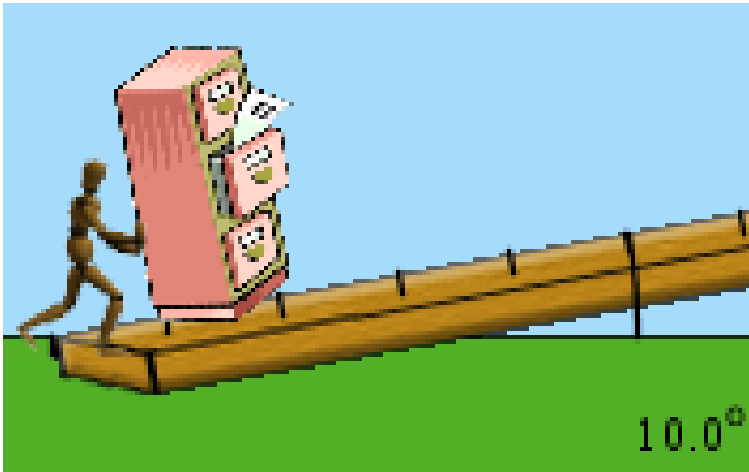

- A. The cabinet will slide down
- B. Betty will push it up the ramp
- C. The cabinet won't move

2. If this is the free body diagram for the fridge, what could be happening

- A. Someone is pushing it up the ramp
- B. It is sliding down the ramp going faster
- C. It is sliding down the ramp going slower
- D. It is sitting still

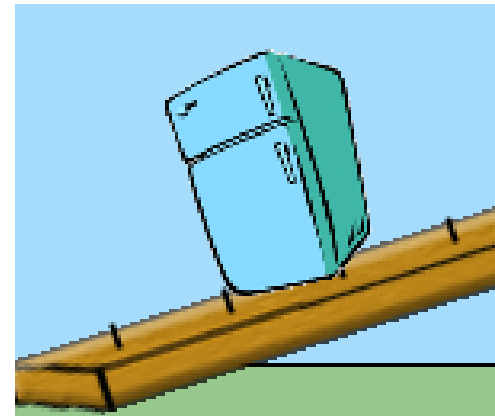
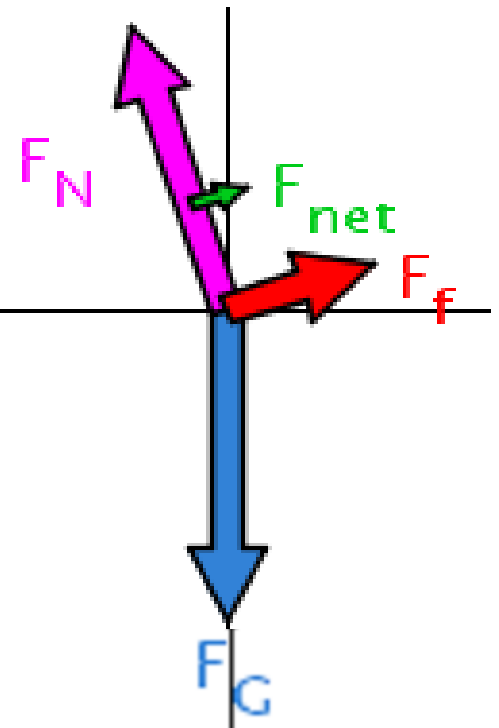

3. One of these diagrams is for a fridge (175 kg) and the other is for a file cabinet (100 kg). If all the conditions are the same, which is the fridge?

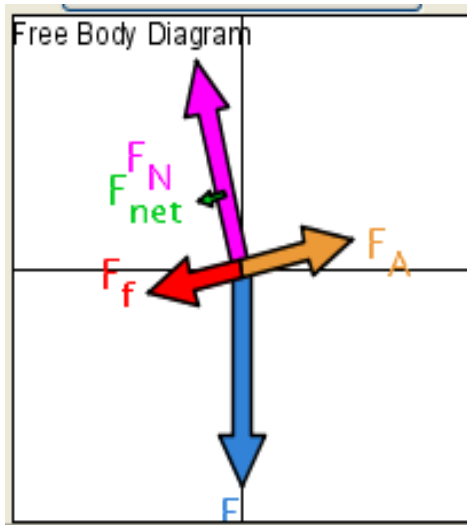
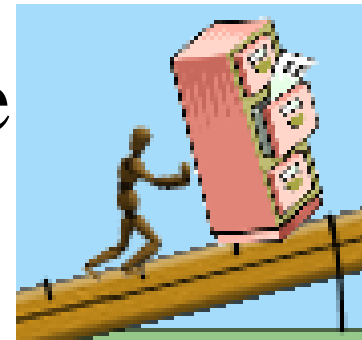
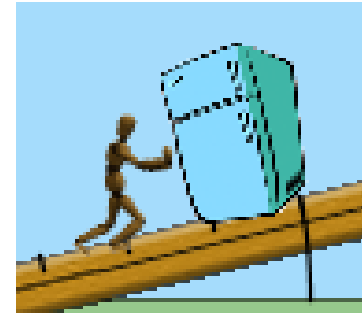

A

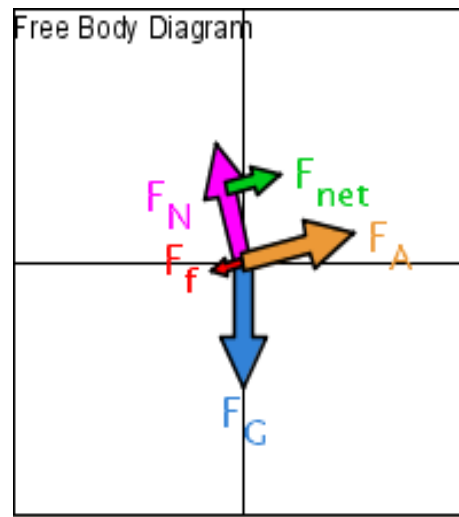

B

C no way to tell

4. Which diagram could show a box of books being lifted straight up?

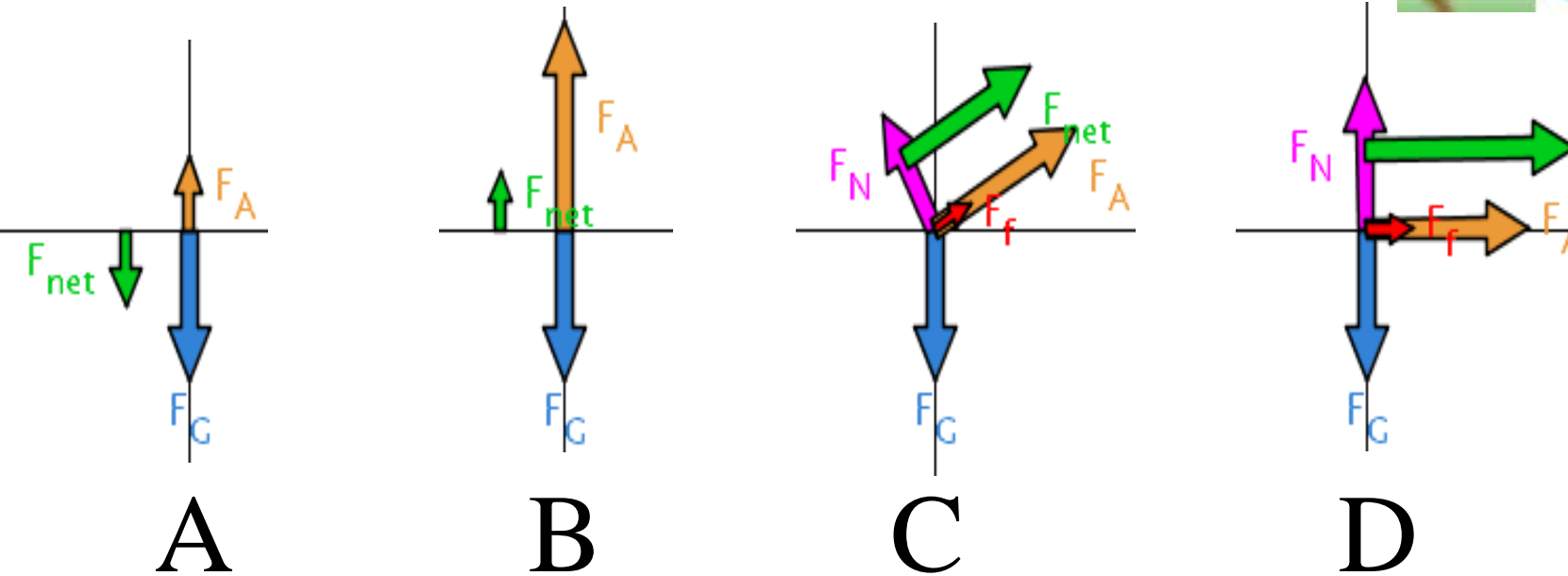

E no way to tell

5. Which would require less pushing force?

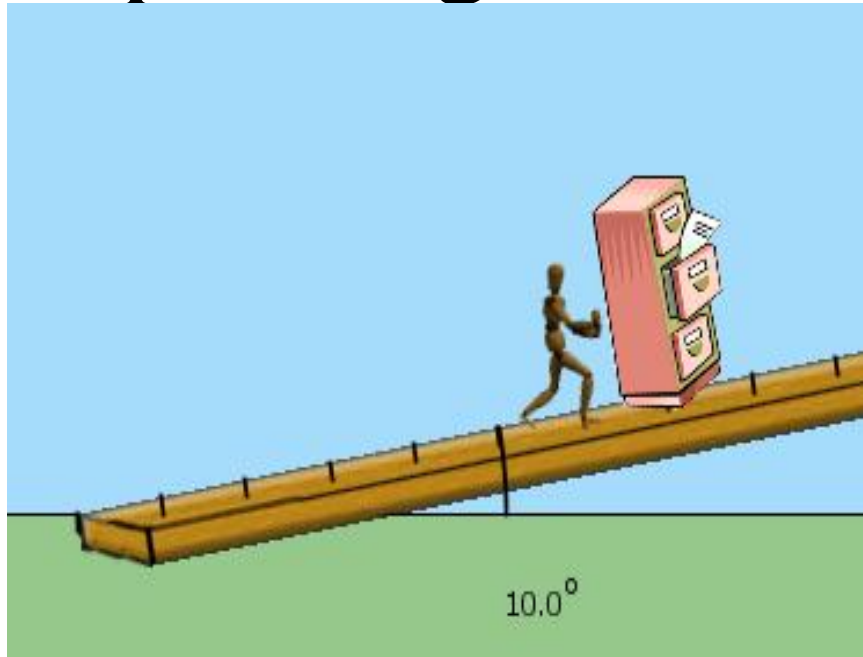

A

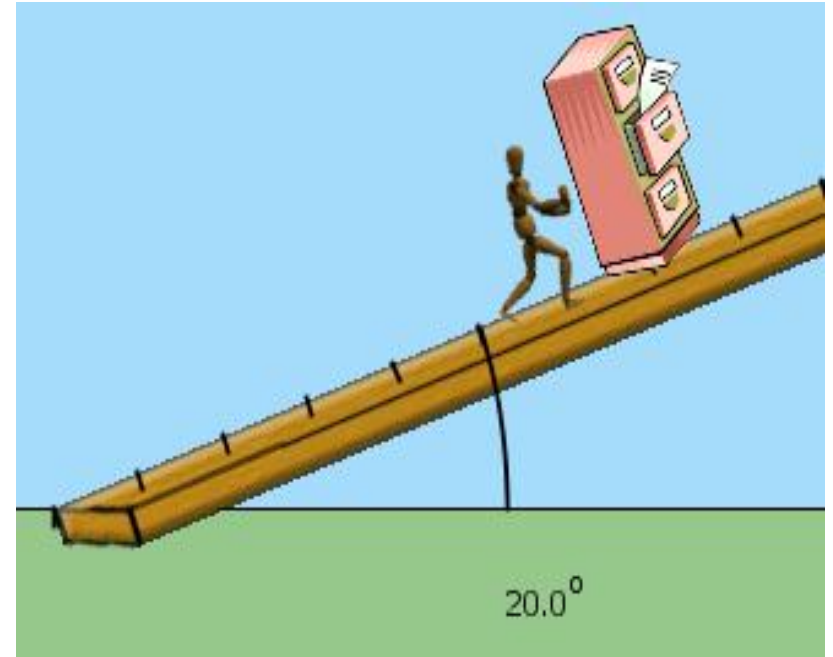

B

C no way to tell



6. It could be easier to push on the  $20^\circ$  ramp, because

- A. The friction force is less
- B. The cabinet weighs less
- C. It is easier to plant your feet

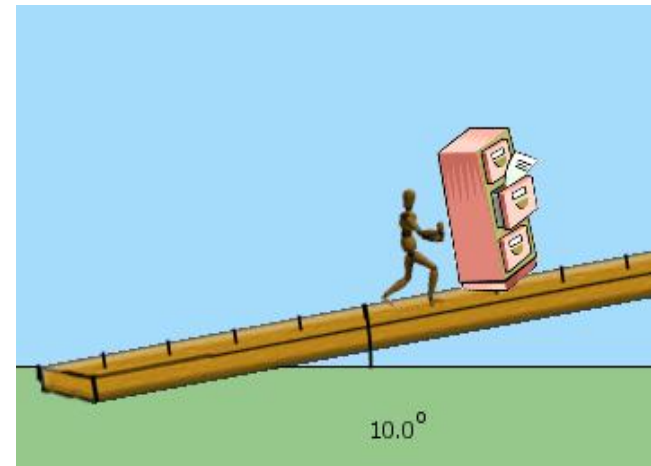
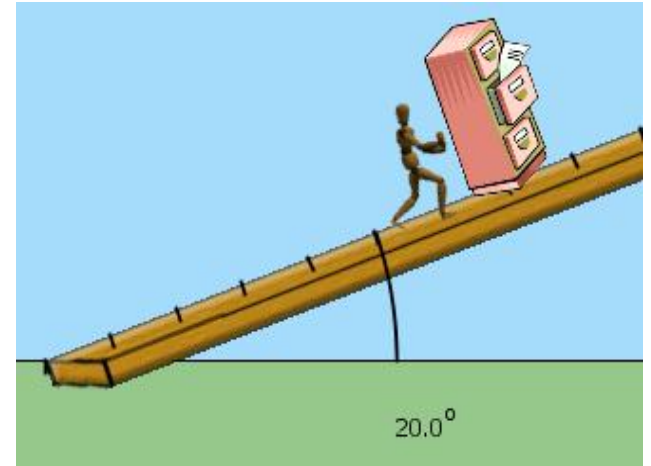

# Geometric Optics: Reflection and Lenses

## Plane mirrors only

Learning Goals: Students will be able to explain (*my notes in italics*)

- How a converging lens makes images. (*real and virtual using ray diagrams*)

How changing the lens (*radius, index and diameter*) effects where the image appears and how it looks



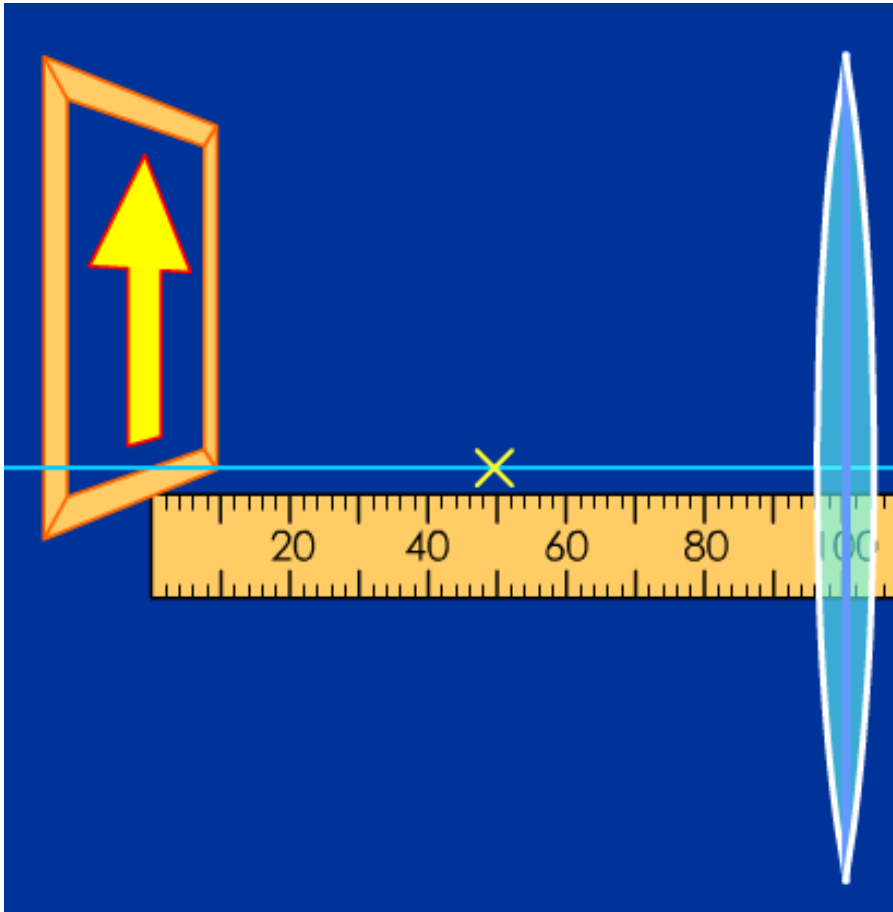

# Where will the image appear?

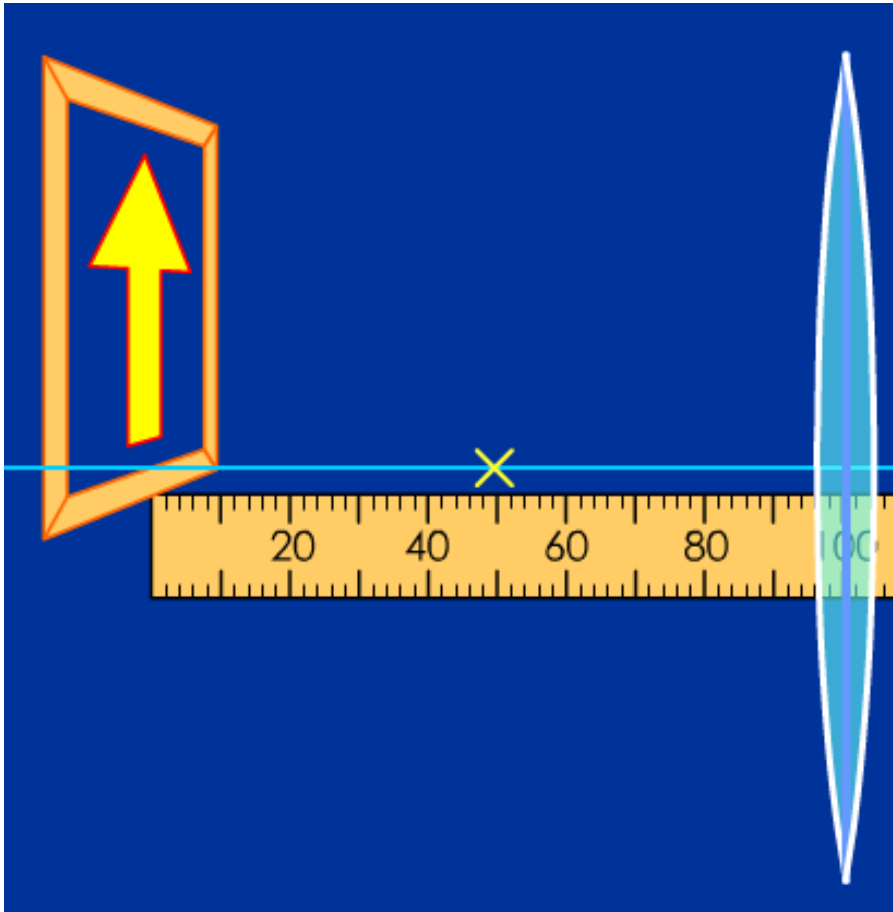

- A. On the left, at the zero mark.
- B. On the right, at the 150 mark.
- C. On the right, at the 200 mark.
- D. On the right, at the 300 mark.

# How will the image look?



- A. Same size 
- B. Smaller 
- C. Larger 
- D. Same size 
- E. Smaller 

- No Rays
- Marginal rays
- Principal rays
- Many rays
- 2nd Point

0.56  
curvature radius(m)

1.56  
refractive index

1.21  
diameter(m)

- change object
- Show Guides
  - Virtual image
  - Screen
  - Ruler

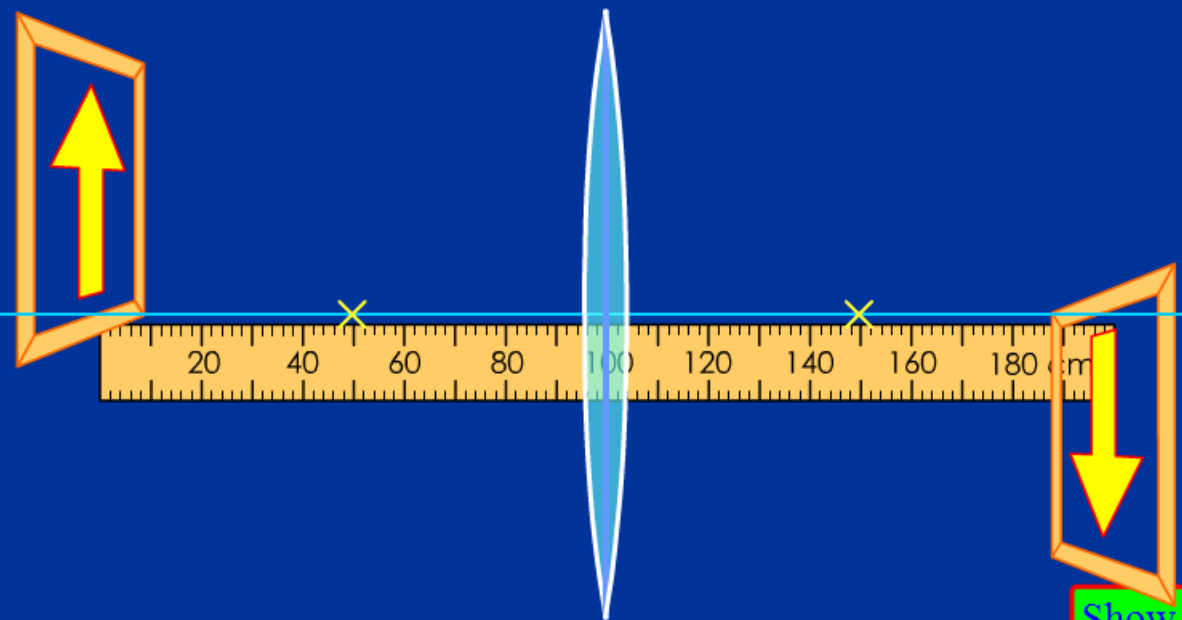

Show Help

Where will the image appear if the lens were concave?

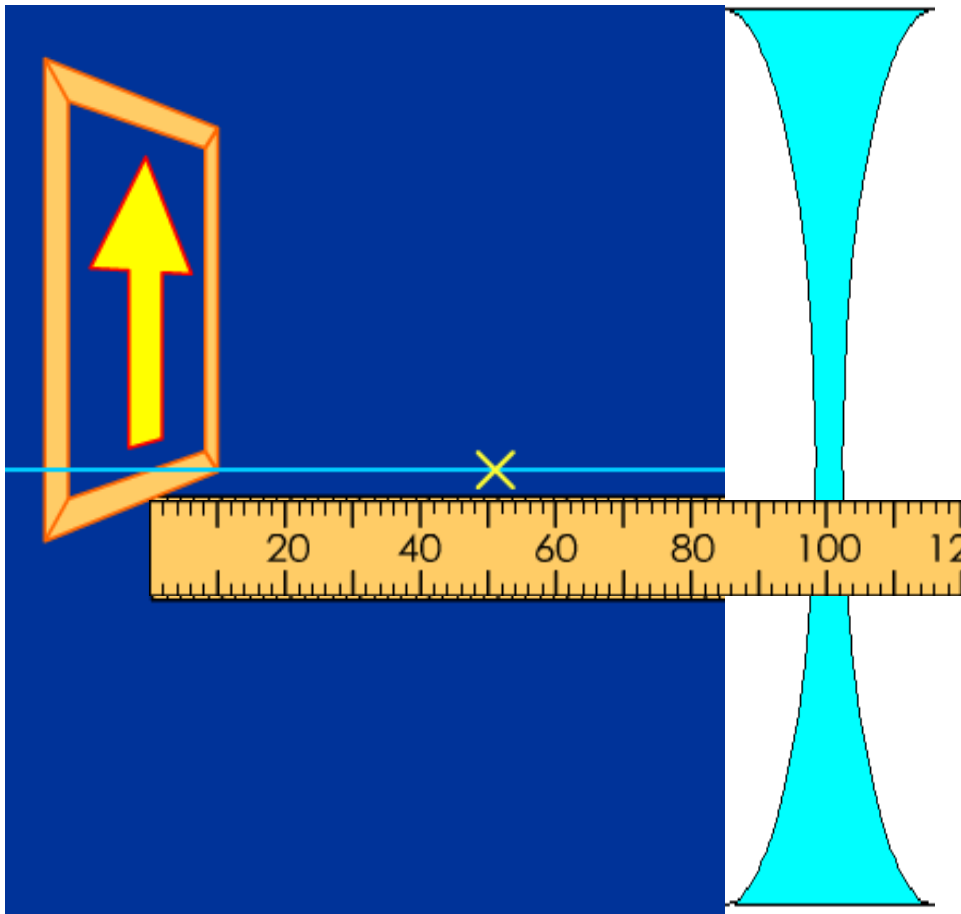

- A. On the left, at the zero mark.
- B. On the left, at the 67 mark.
- C. On the left, at the 33 mark.
- D. On the right, at the 200 mark.

# How will the image look?

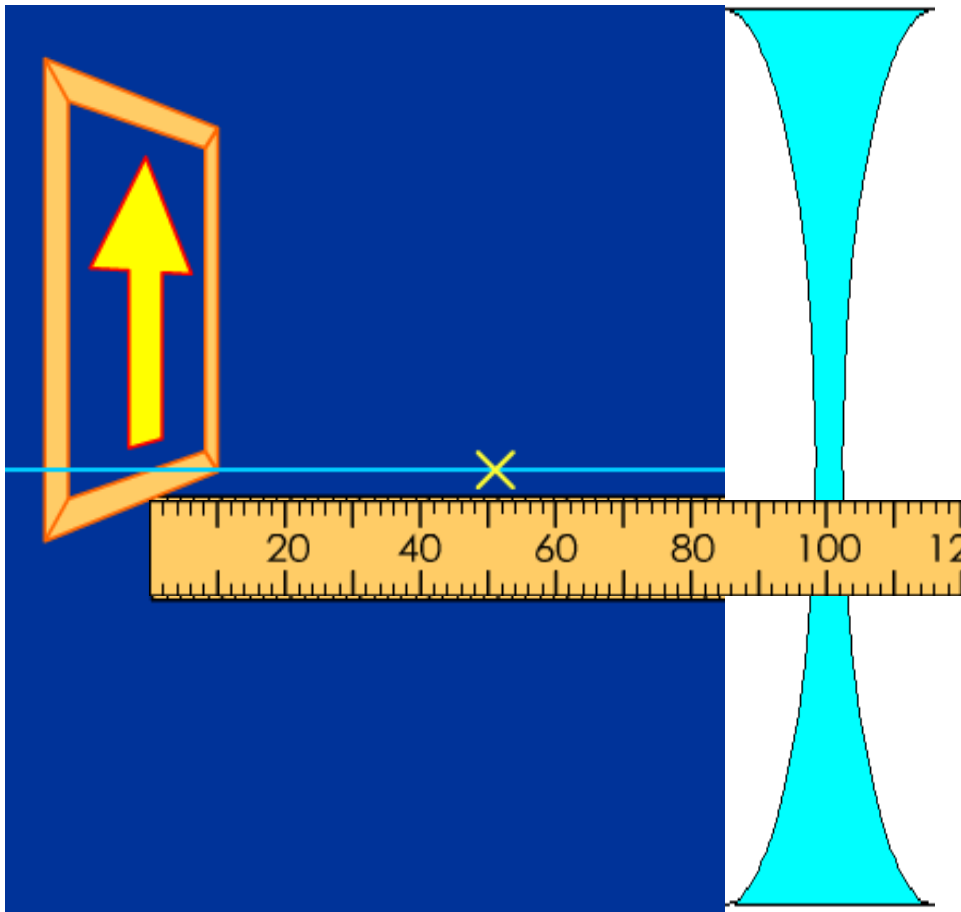

A. Same size 

B. Smaller 

C. Larger 

D. Same size 

E. Smaller 

If the lens is made fatter in the middle, how will the image change?

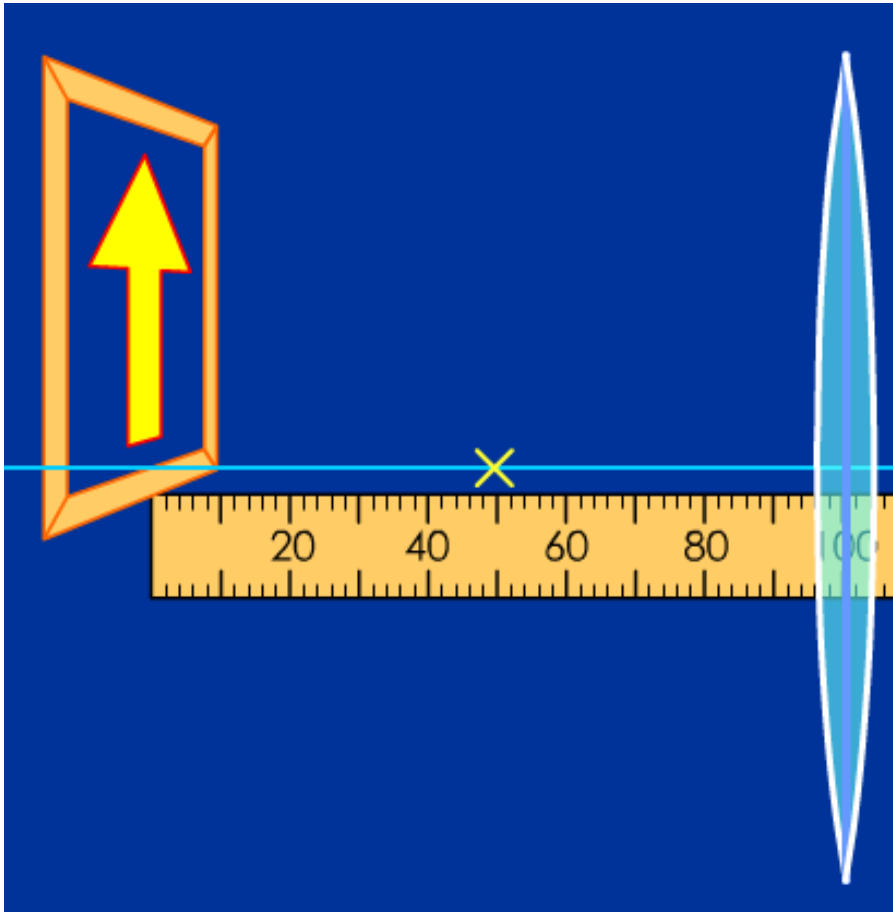

- A. Larger, further away
- B. Smaller, further away
- C. Larger, closer
- D. Smaller, closer





- No Rays
- Marginal rays
- Principal rays
- Many rays
- 2nd Point

0.3      1.56      1.21

curvature radius(m)      refractive index      diameter(m)

- [change object](#)
- Show Guides
  - Virtual image
  - Screen
  - Ruler

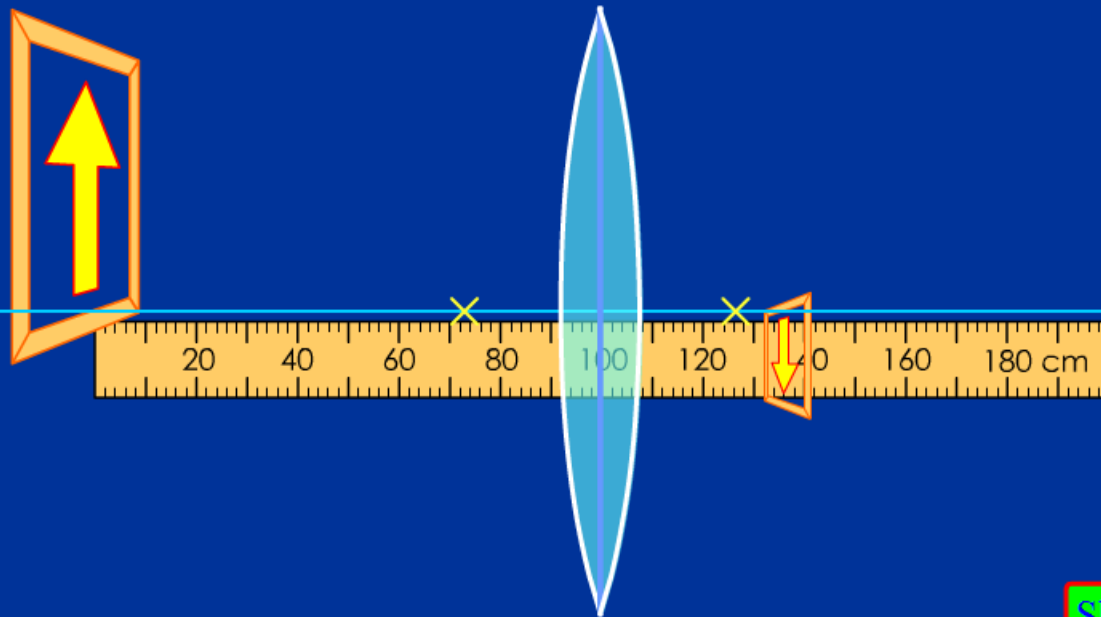

Show Help

If you replace the lens with a mirror, the image will be

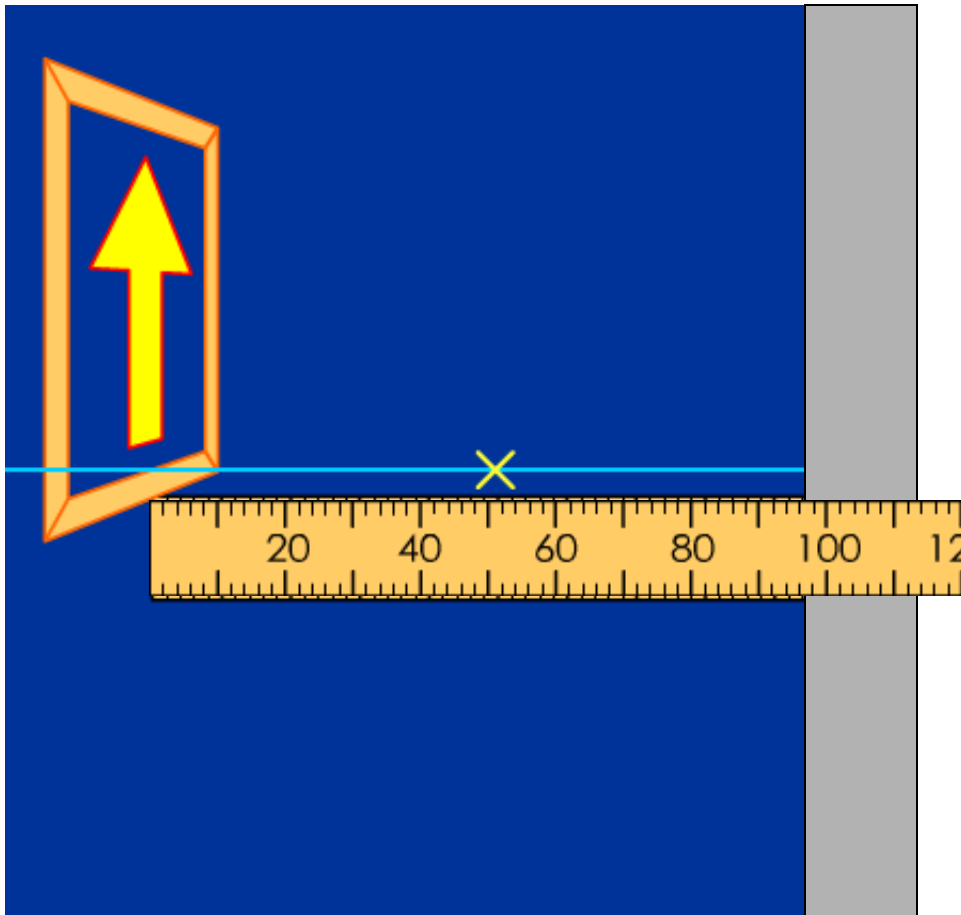

A. Same size 

B. Smaller 

C. Larger 

D. Same size 

E. Smaller 



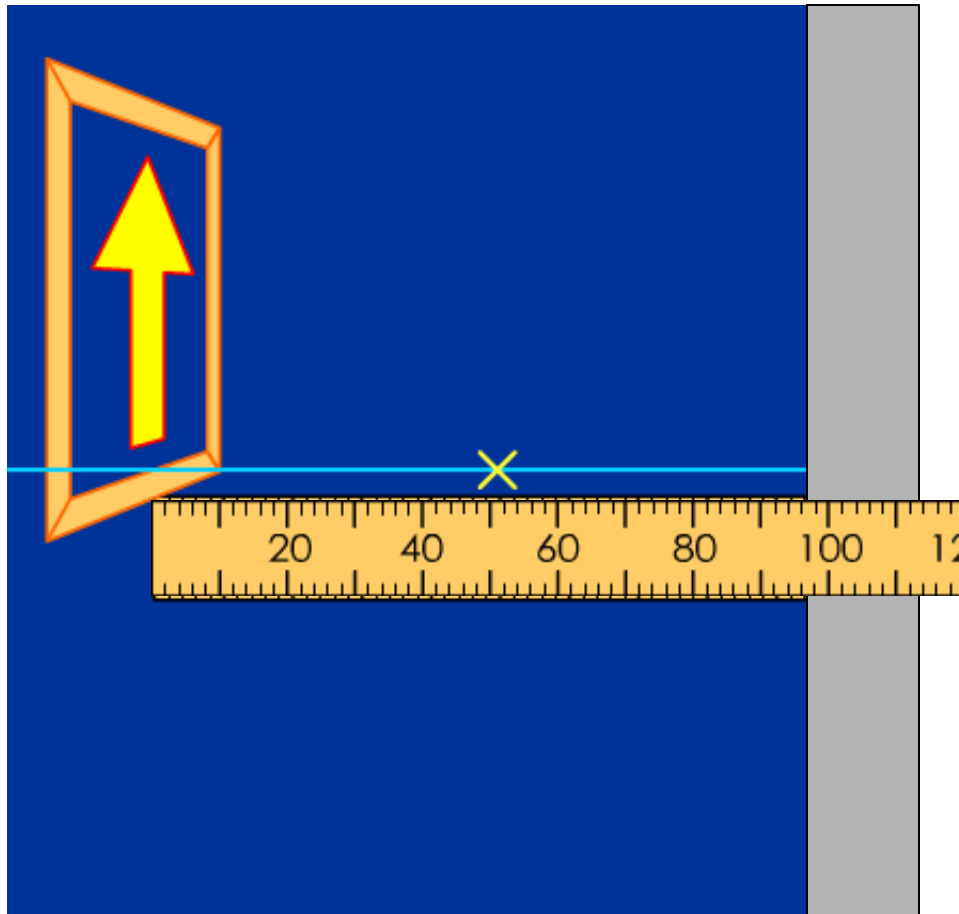

If you move the arrow towards the mirror, the image will be

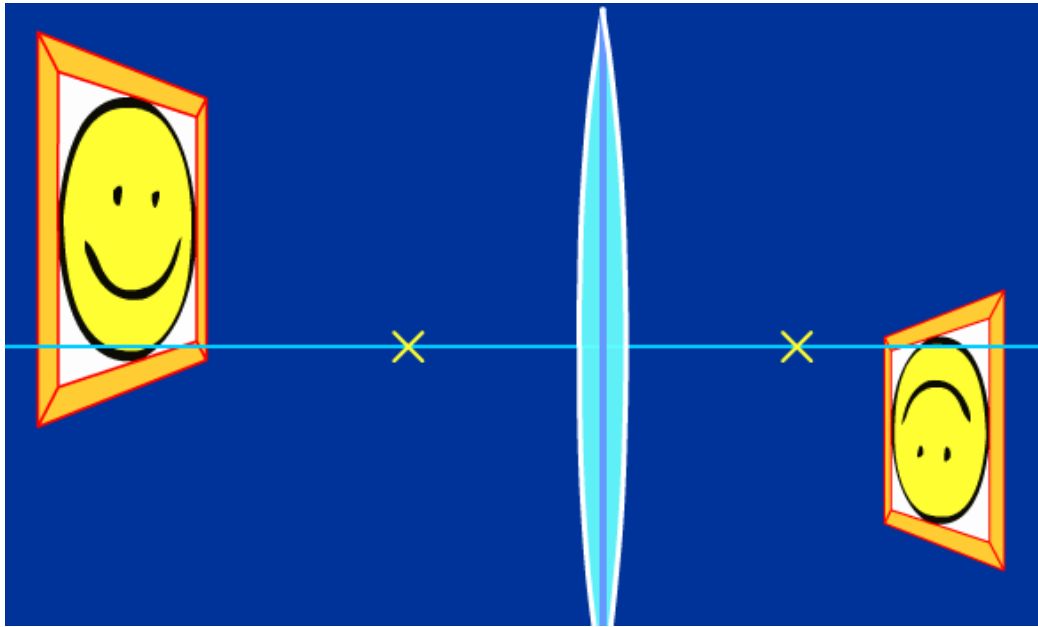

- A. Same size ↑
- B. Smaller ↑
- C. Larger ↑
- D. Same size ↓
- E. Smaller ↓

If the lens had a lower index of refraction, the image be



- A. Same size 
- B. Smaller 
- C. Larger 
- D. Same size 
- E. Smaller 

No Rays  
 Marginal rays  
 Principal rays  
 Many rays  
 2nd Point

0.56 curvature radius(m)    1.81 refractive index    1.21 diameter(m)

change object  
 Show Guides  
 Virtual image  
 Screen     Ruler

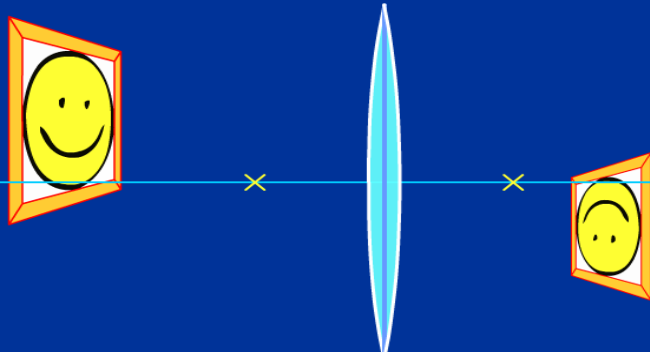

No Rays  
 Marginal rays  
 Principal rays  
 Many rays  
 2nd Point

0.56 curvature radius(m)    1.53 refractive index    1.21 diameter(m)

change object  
 Show Guides  
 Virtual image  
 Screen     Ruler

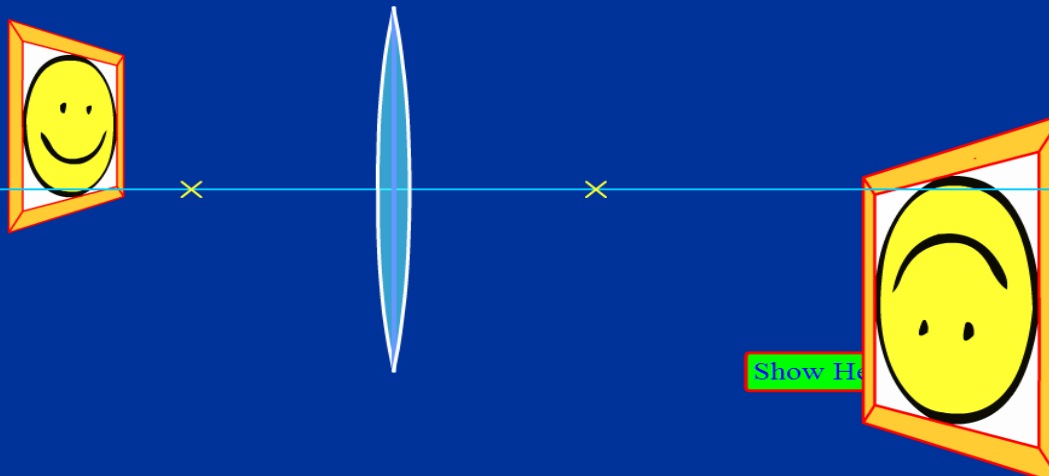

# Electric Field hockey and Charges and Fields

Learning Goals: Students will be able to

- Determine the variables that affect how charged bodies interact
- Predict how charged bodies will interact
- Describe the strength and direction of the electric field around a charged body.
- Use free-body diagrams and vector addition to help explain the interactions.

All but the last 2 questions are adapted from Perkins' homework for a PHYS1010 lecture on electric charges from CU Boulder. The assignment can be downloaded from the PhET Teaching Ideas pages.

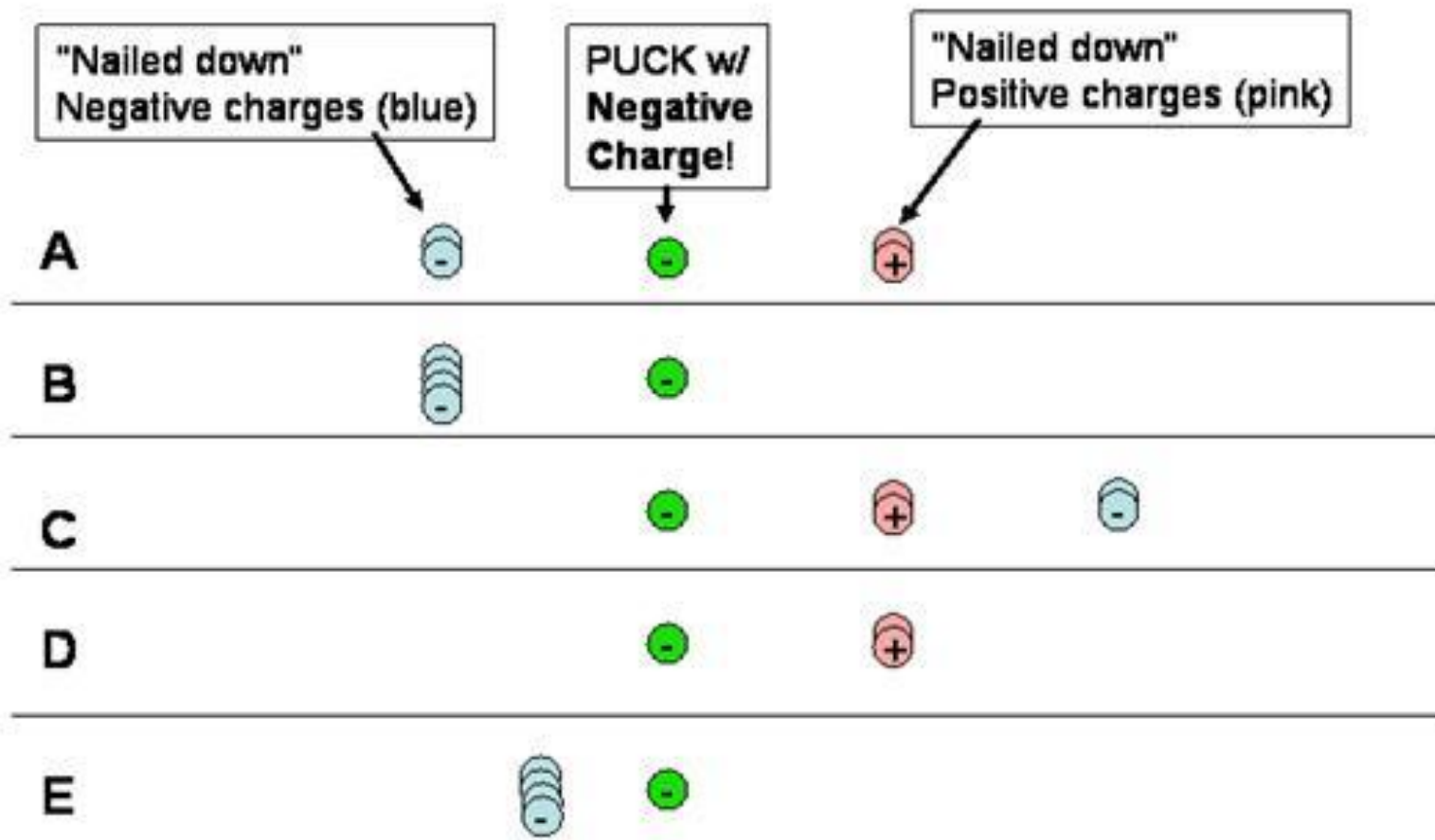

All of the pucks • feel a force to the right.

**A. True    B. False**

"Nailed down"  
Negative charges (blue)

PUCK w/  
Negative  
Charge!

"Nailed down"  
Positive charges (pink)



The puck ● in C feels a greater force to the right than the puck in D.

**A. True    B. False**



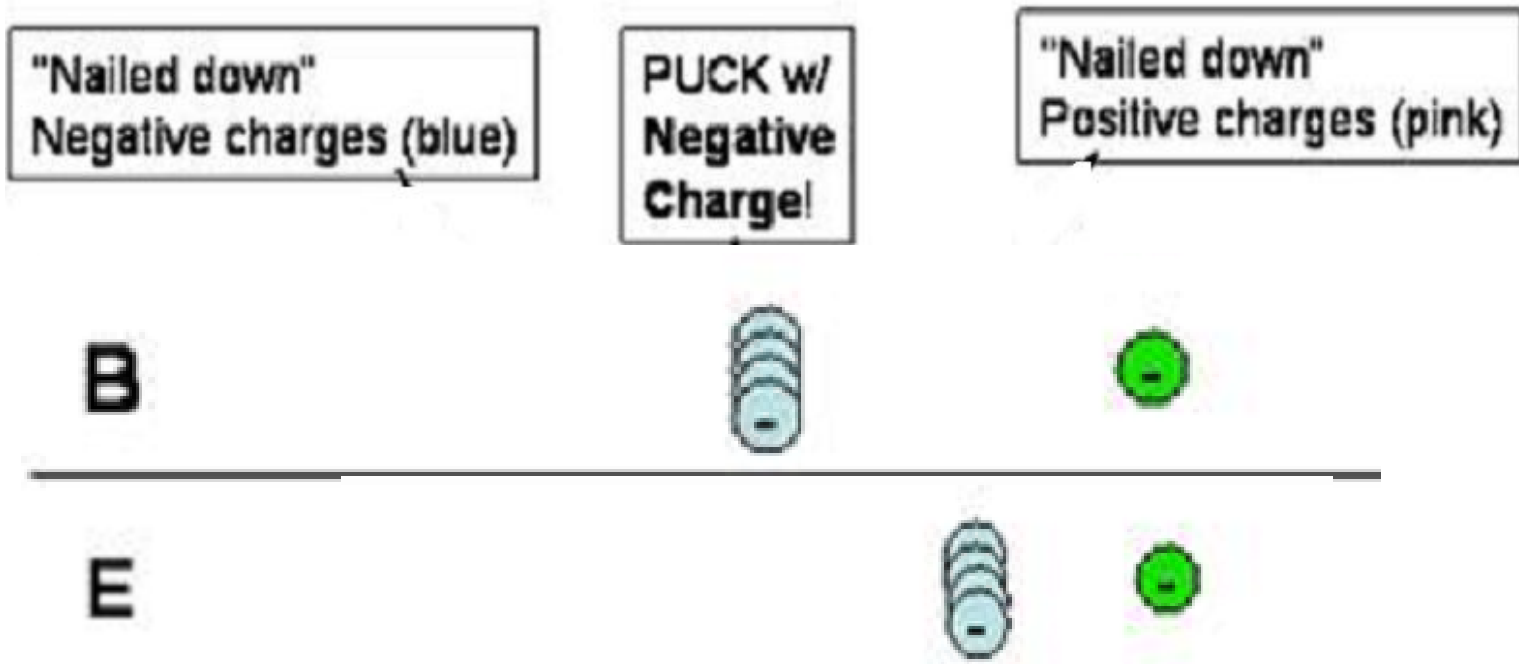

The puck  in E feels a force to the right that is four times greater than that felt by the puck in B.

**A. True    B. False**

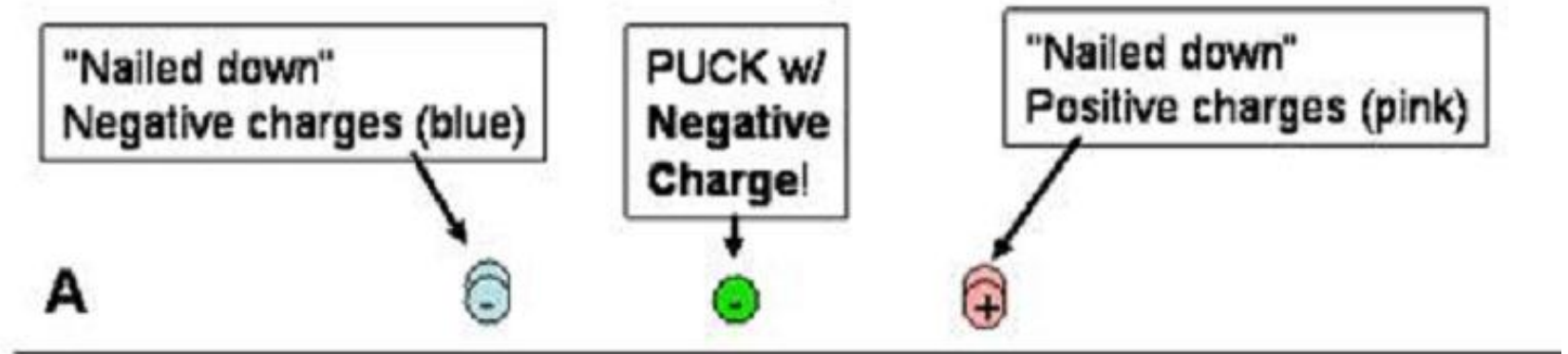

The net force on the puck  in A is zero.

**A. True    B. False**

For which of these choices is puck most likely not to move?

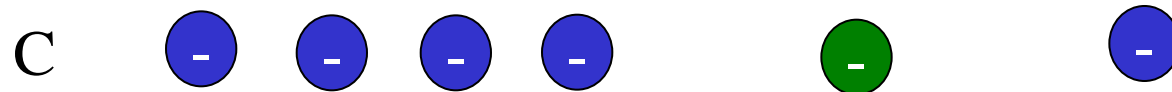
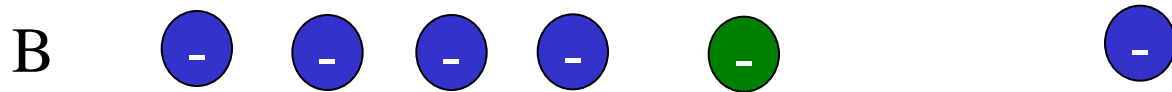
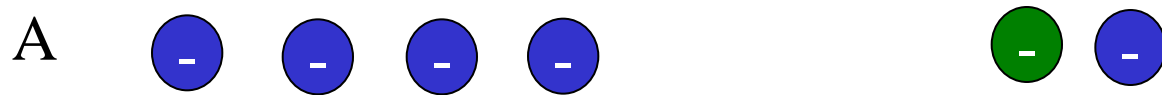

# Answer A Look at forces from each charge and add them up

A

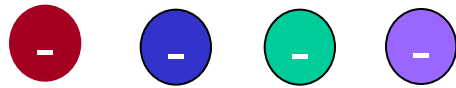

Color-code  
force from each  
charge.

If we put bunch of electrons in a box.  
They will

- a. clump together.
- b. spread out uniformly across box.
- c. make a layer on walls.
- d. do something else.

Which one would help explain why a charged balloon sticks to a wall.

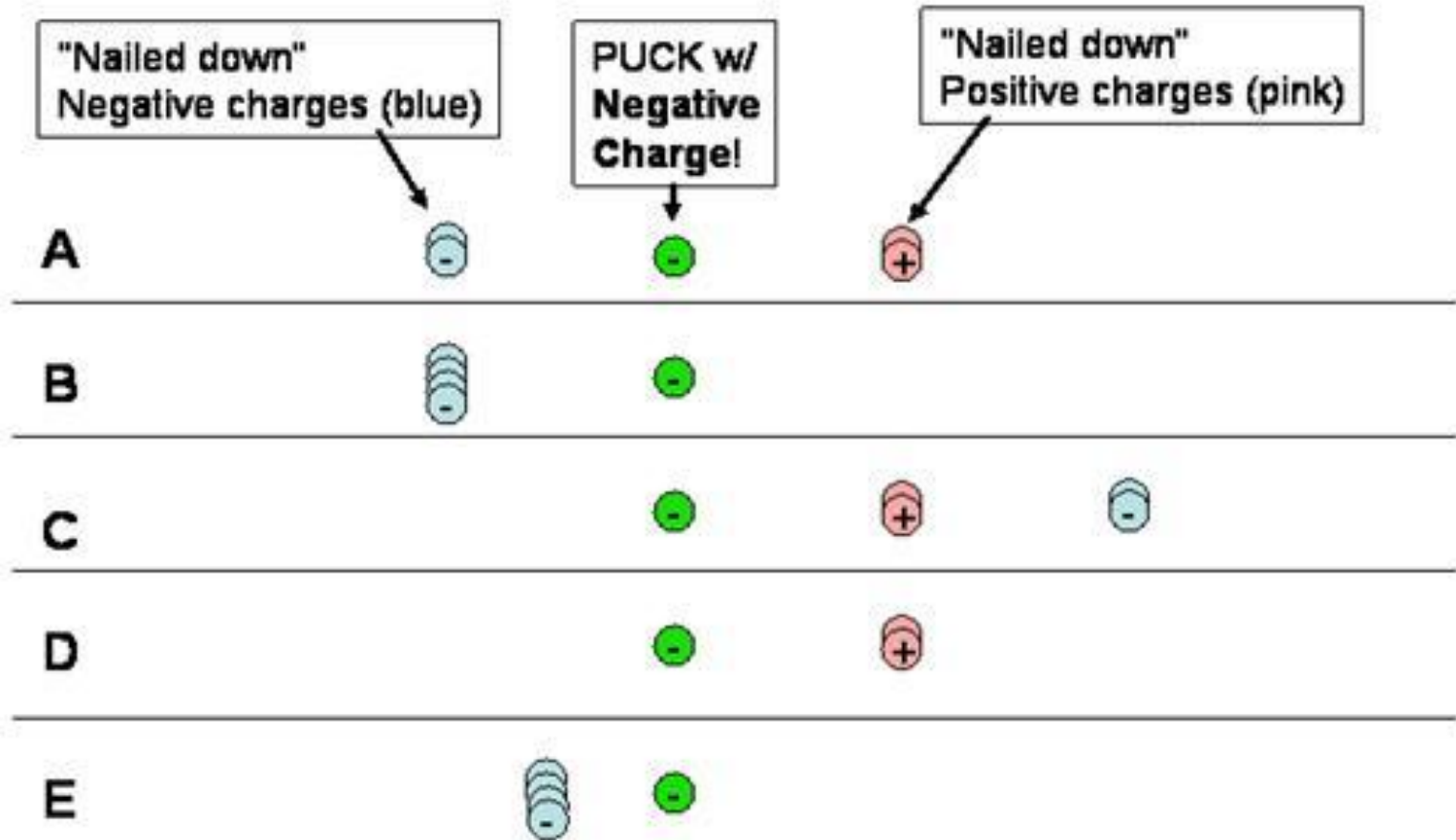

Which arrow best represents the direction of acceleration of the puck as it passes by the wall?

Electric Hockey, Level 1

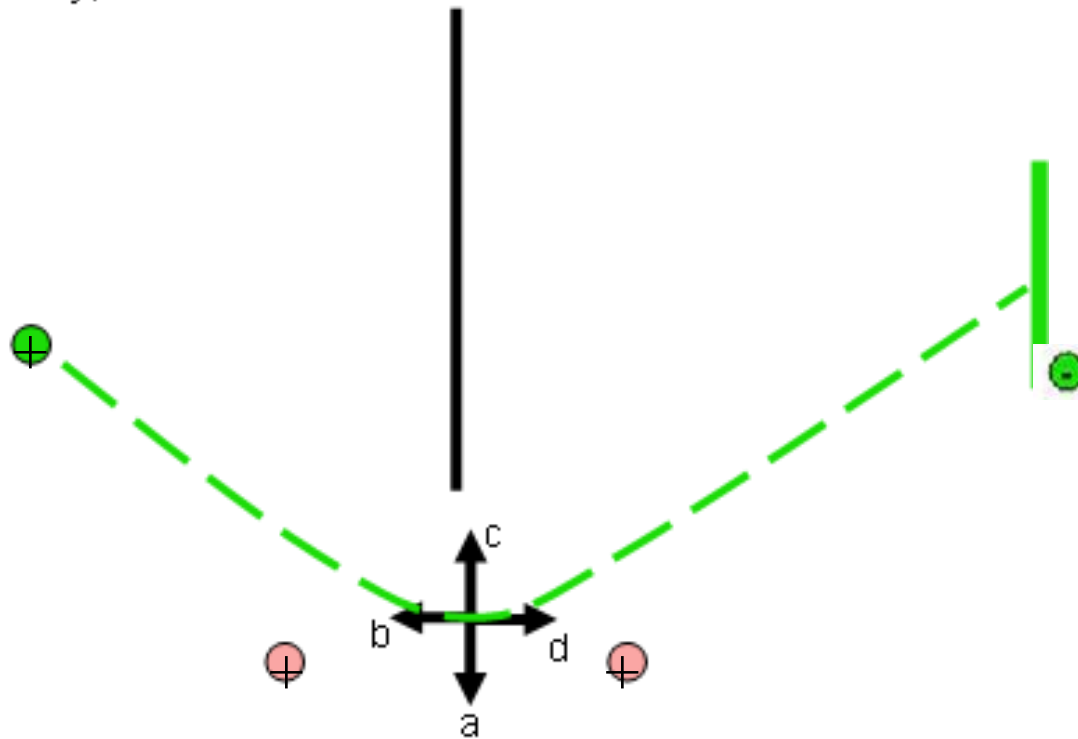

A positive charge might be placed at one of three different locations in a region where there is a uniform electric field, as shown.

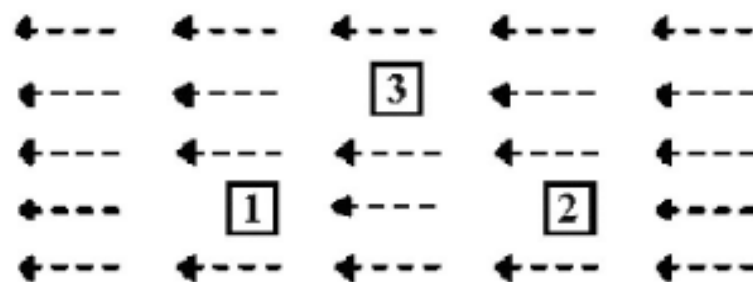

How do the electric force,  $F$ , on the charge at positions 1, 2, and 3 compare?

1.  $F$  is greater at 1.
2.  $F$  is greater at 2.
3.  $F$  is greater at 3.
4.  $F$  is zero at all three places.
5.  $F$  at all three positions is the same but not zero.



When a positive charge is released from rest in a uniform electric field, it will

1. remain at rest in its initial position.
2. move at a constant acceleration.
3. move at a constant velocity.
4. move with a linearly changing acceleration.
5. you can't tell from the information given

# Maze game 1 clicker questions

**Learning Goals:** Students will be able to

- Maneuver through the maze controlling position, velocity, or acceleration.

In activity, but not covered in clicker questions:

- Explain game strategies using physics principles.

1. Which one best shows where the red ball would be?

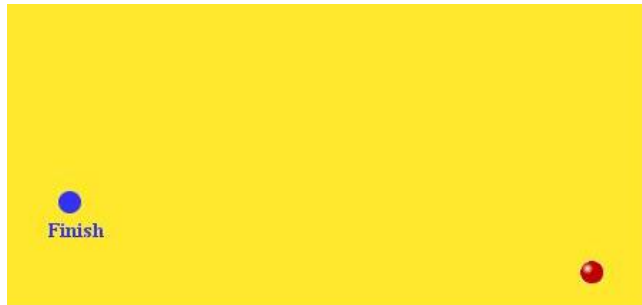
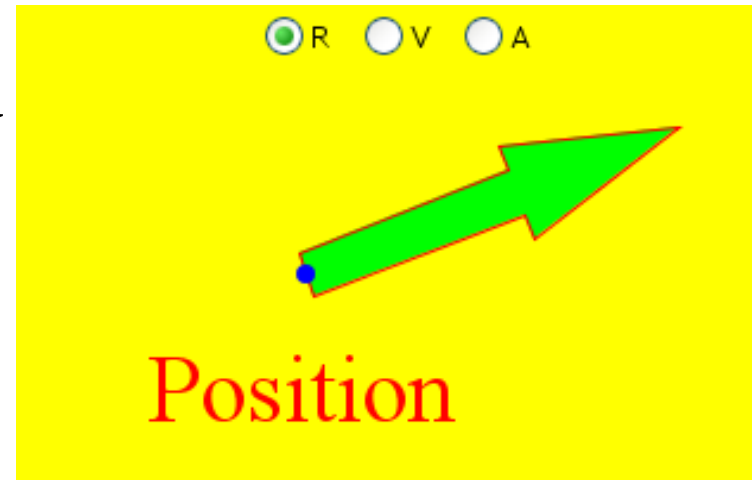

A

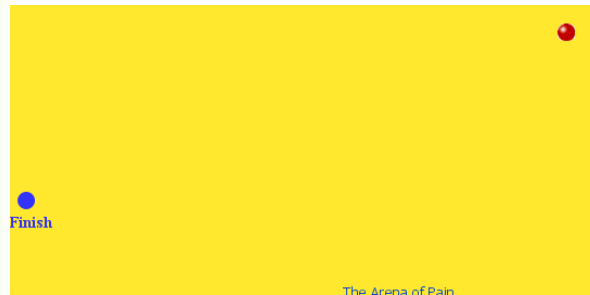

B



C

2. Which best describes how the red ball will move?

- A. Up the page
- B. Down the page
- C. Toward the Finish
- D. Away from the Finish
- E. No way to predict

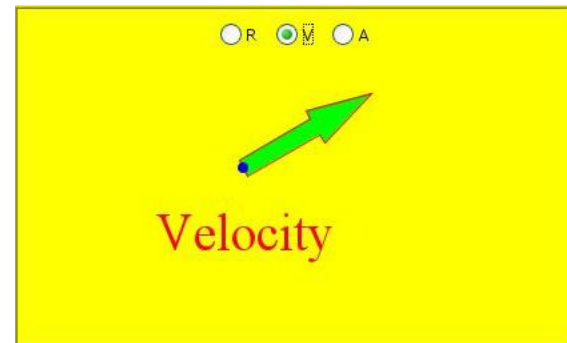
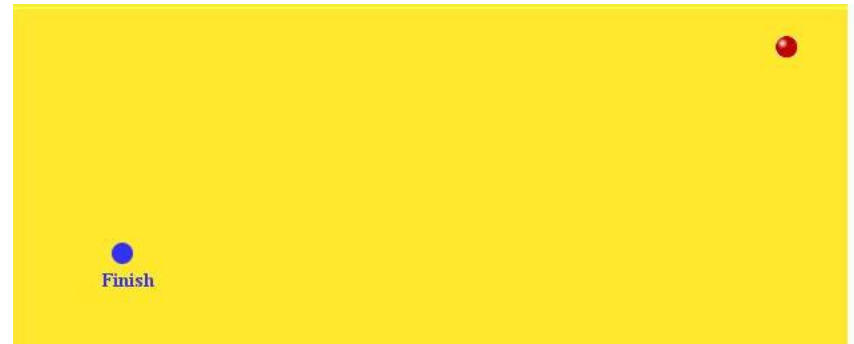

3. Which best describes how the red ball will move?

- A. Up the page
- B. Down the page
- C. Toward the Finish
- D. Away from the Finish
- E. No way to predict

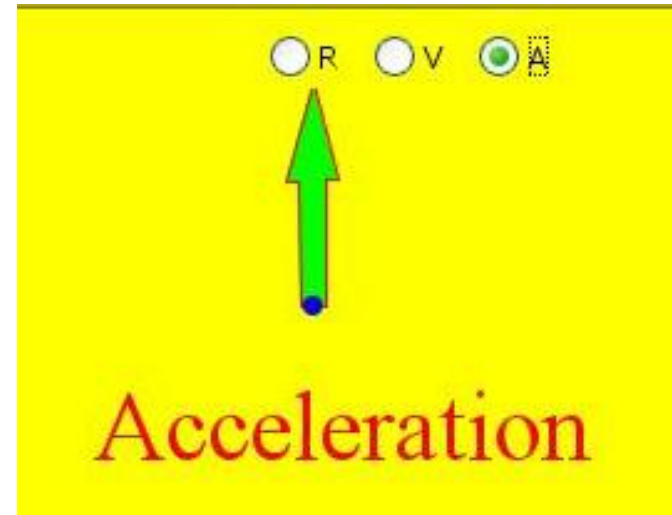
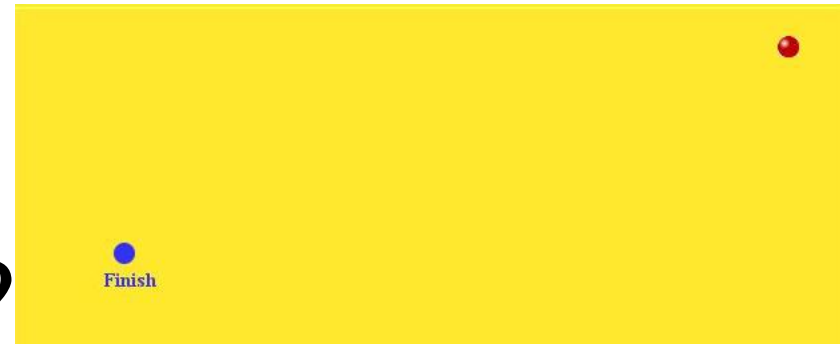

4. If you made the ball up down the page with this velocity vector, and then changed the acceleration to this vector, what would the ball do?

- A. Change direction and go down the page immediately
- B. Go up the page faster
- C. Go up the page slower

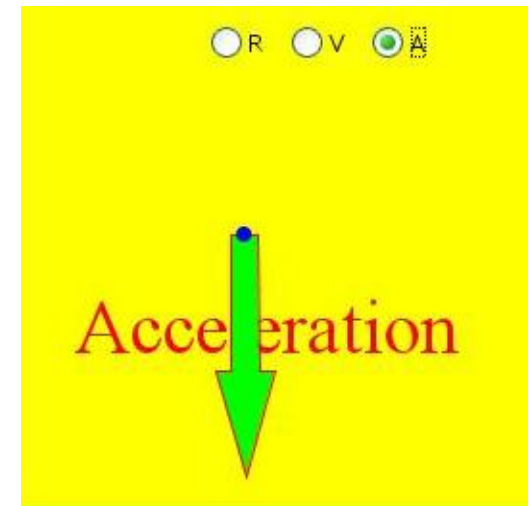
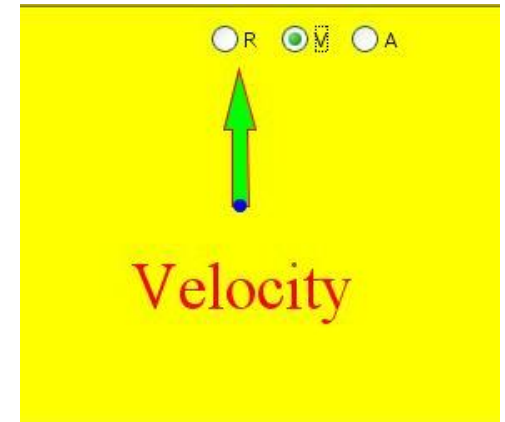

# Pendulum Lab Activity 1

**Learning Goals:** Students will be able to:

- Design experiments to describe how variables affect the motion of a pendulum.
- Use a photogate timer to determine quantitatively how the period of a pendulum depends on the variables you described.

I plan to have the sim open to demonstrate the answers, but I have included the results from the photogate timer just for precise evidence.

Trish Loeblein updated 7/20/2008

1. Which one swings faster?

A. They go the same speed

B. 1 is faster

C. 2 is faster

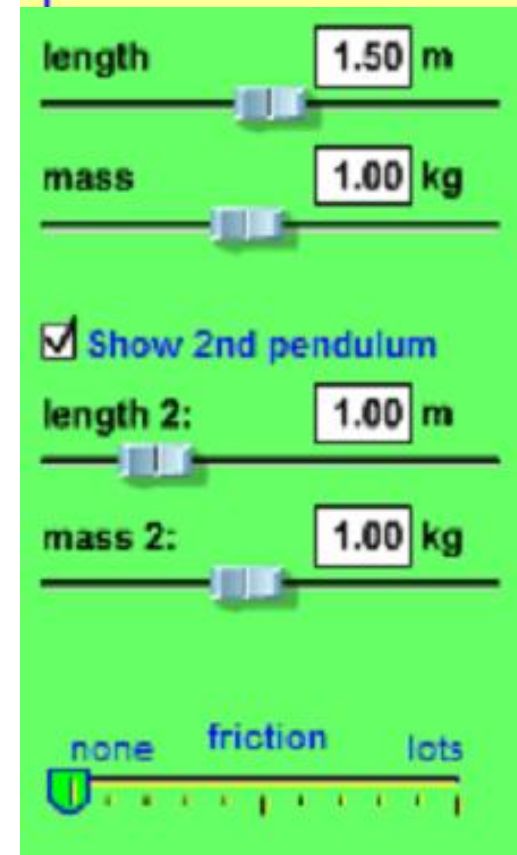
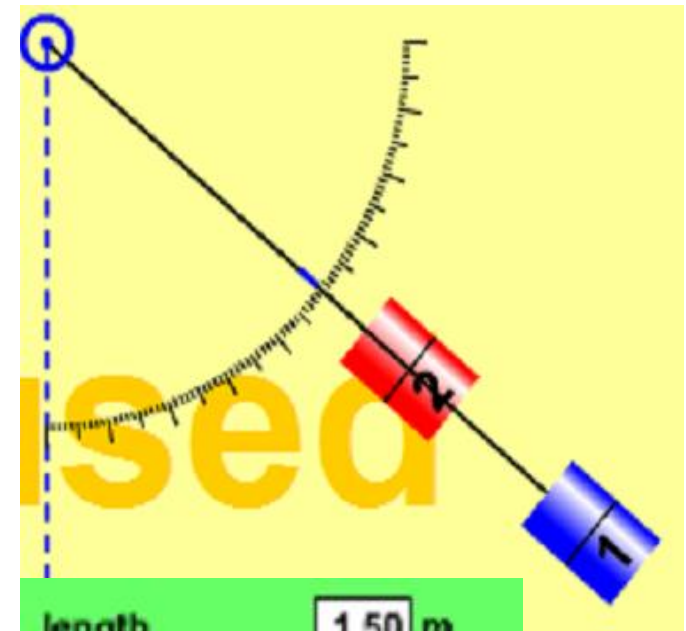



# Answer to 1

photogate timer

Pendulum:  1  2

period:

photogate timer

Pendulum:  1  2

period:

2. What is true about the maximum angle as they swing left?

A. They have the same max angle

B. 1 swings to a greater angle

C. 2 swings to a greater angle

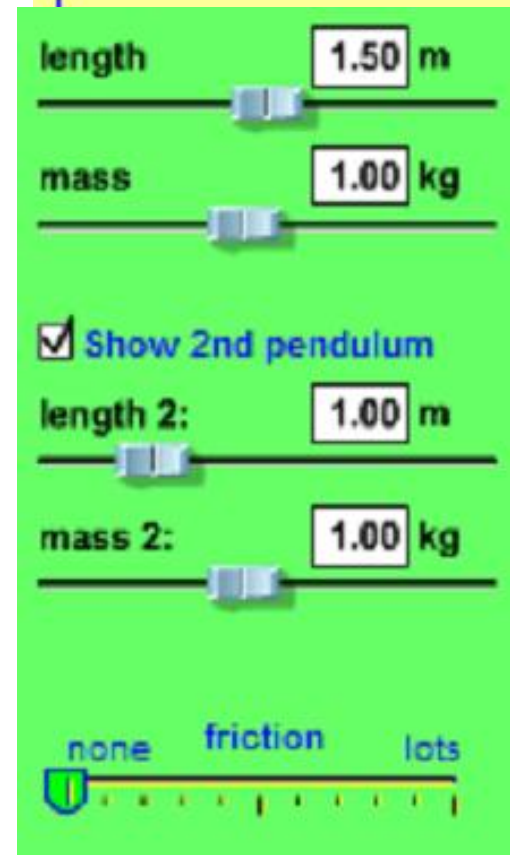
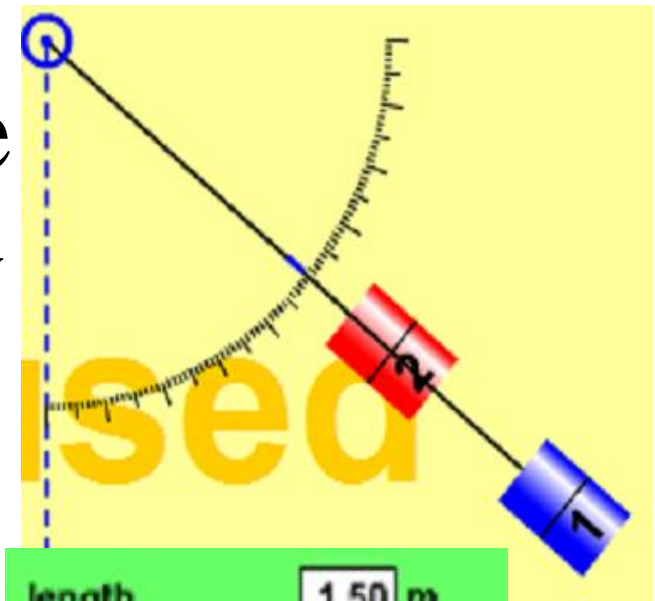

3. What will be the differences in the swinging patterns?

- A. There are no differences
- B. **1** swings higher; stops last
- C. **1** swings higher; stops first
- D. **1** swings lower; stops first
- E. **1** swings lower; stops last

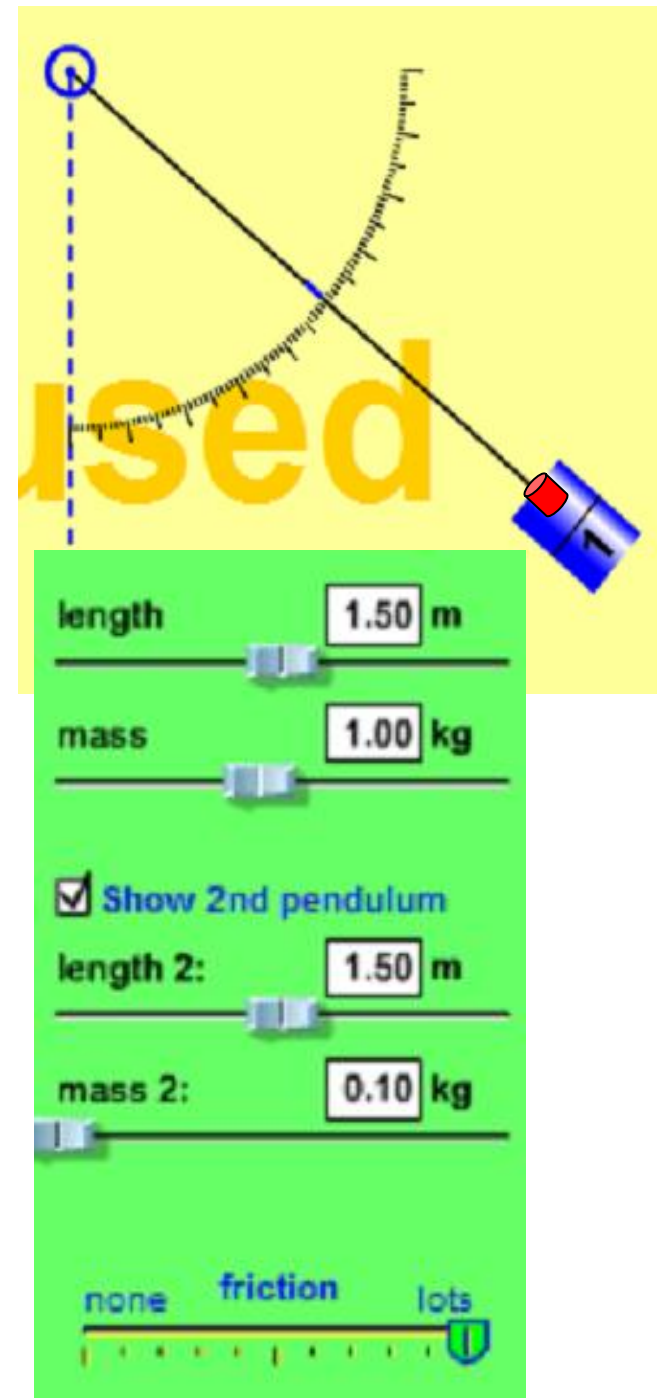

4. Which one will stop first?

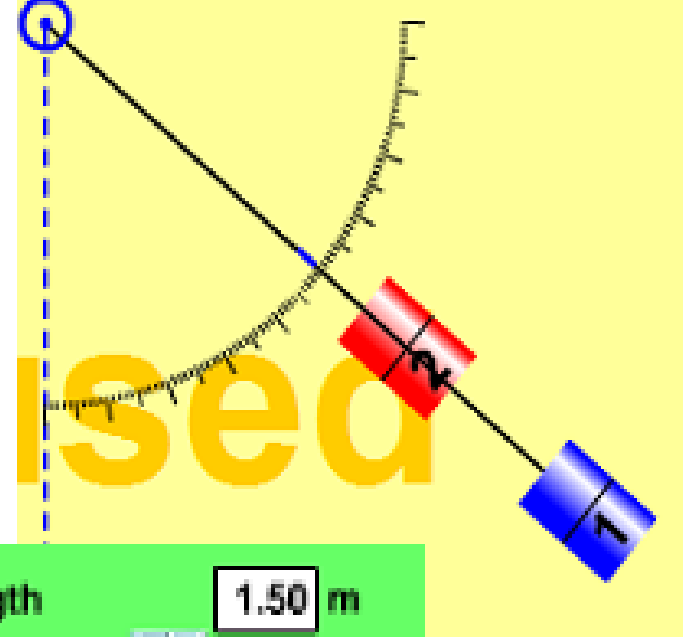

A. They stop at the same time

B. 1 stops first

C. 2 stops first

length 1.50 m

mass 1.00 kg

Show 2nd pendulum

length 2: 1.00 m

mass 2: 1.00 kg

none friction lots

The image shows a control panel for a pendulum simulation. It features several sliders and checkboxes. The first pendulum's length is set to 1.50 m and its mass to 1.00 kg. A checkbox labeled 'Show 2nd pendulum' is checked. The second pendulum's length is set to 1.00 m and its mass to 1.00 kg. At the bottom, there is a slider for friction, with labels 'none', 'friction', and 'lots'. The slider is currently positioned at the 'lots' end, indicated by a blue shield icon.

5. Which has the shortest period?

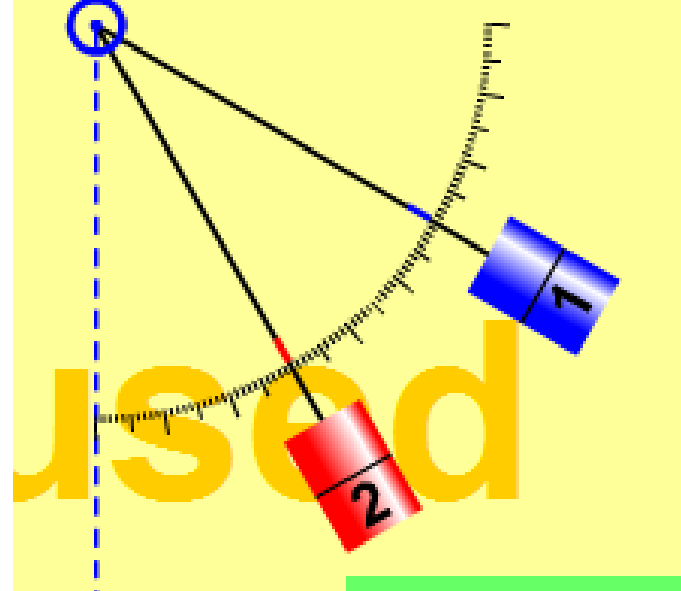

A. They have equal periods

B. 1 has a shorter period

C. 2 has a shorter period

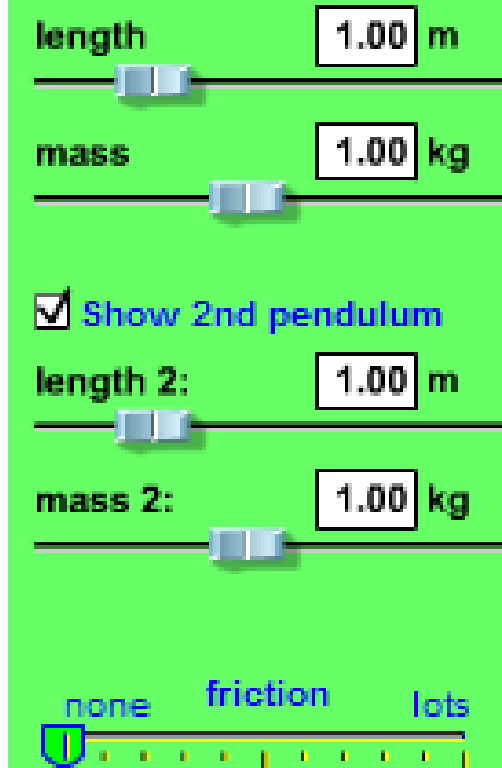

# Answer to 5

photogate timer

Pendulum:  1  2

period:

photogate timer

Pendulum:  1  2

period:

# Balloon and Bouyancy

Learning Goals: Students will be able on a molecular level to

1. Explain why a rigid sphere would float or sink.
2. Determine what causes helium balloon to rise up or fall down in the box.
3. Describe the differences between the hot air balloon, rigid sphere, and helium balloon.
4. Explain why a hot air balloon has a heater.

Teacher note: If you are going to use the simulation to demonstrate, remember that Reset only clears the box of particles, it does not change any settings.

# Would you expect the rigid sphere to float or sink?

- A. Sink
- B. Float

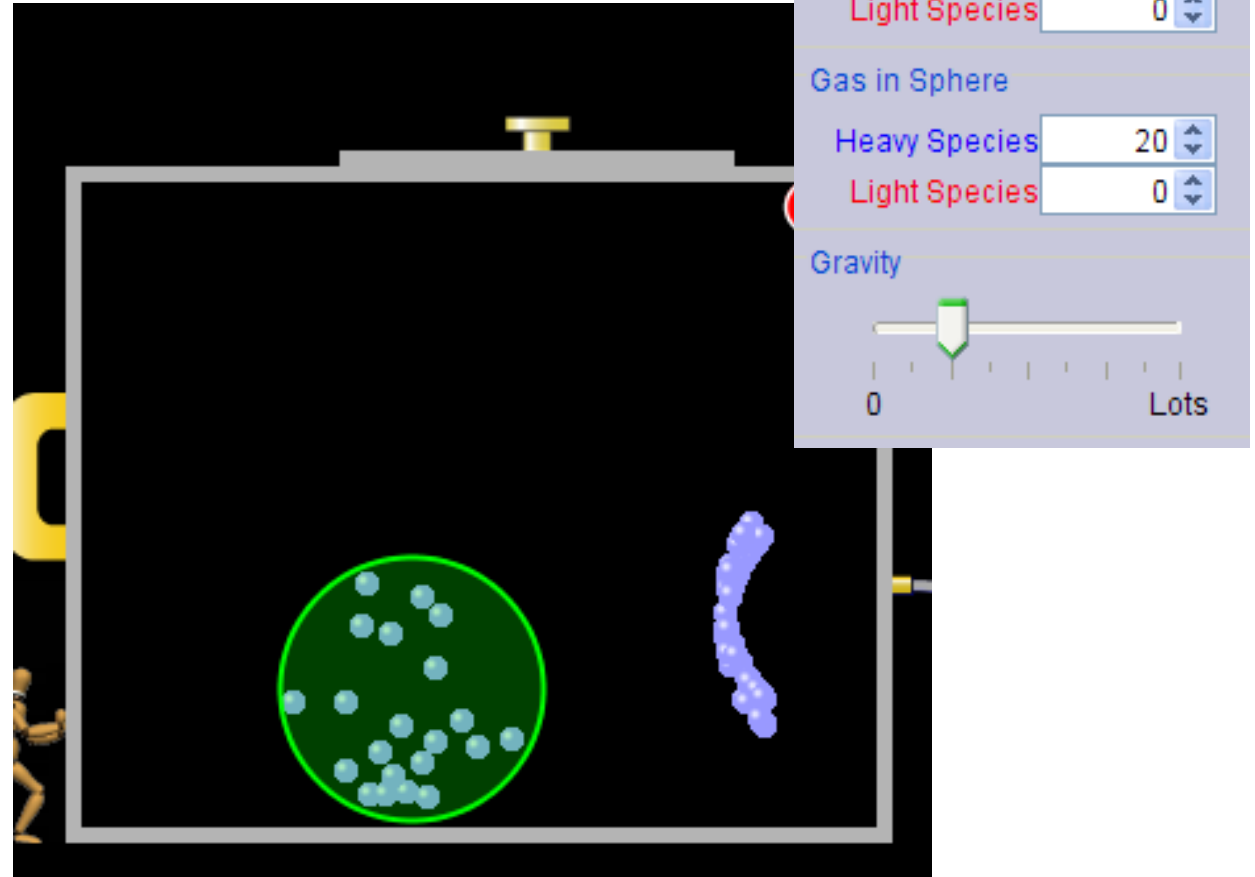



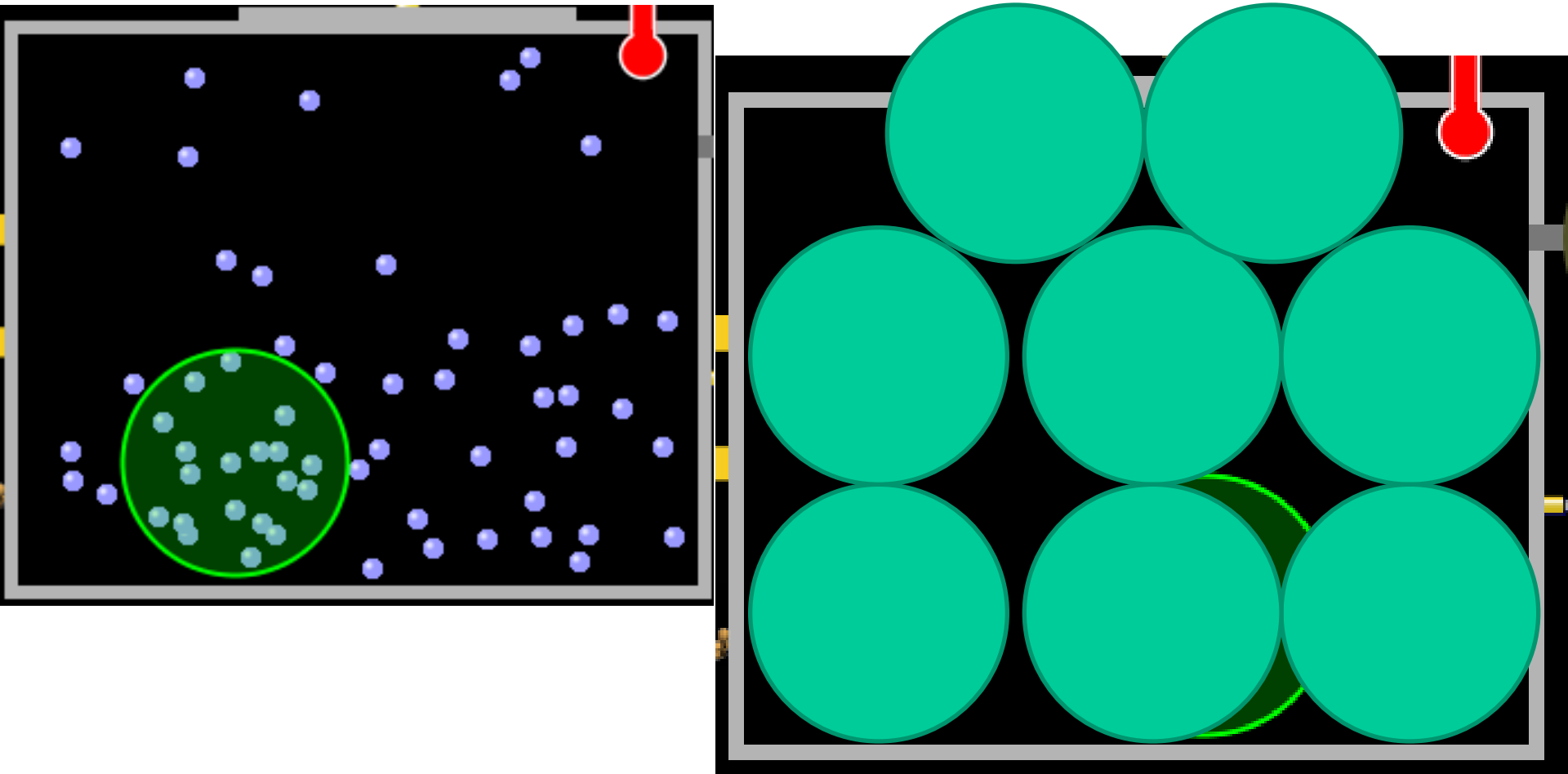

The container is about 8 times larger so the density is much greater in the sphere

# Would you expect the rigid sphere to float or sink?

- A. Sink
- B. Float

The simulation shows a rigid sphere (green) containing blue particles, submerged in a red liquid. The chamber contains a mixture of blue particles and a red liquid. A control panel on the right shows the following settings:

Gas in Chamber	
Heavy Species	60
Light Species	0

Gas in Sphere	
Heavy Species	21
Light Species	0

Gravity: 0 to Lots (slider set to approximately 1/3)

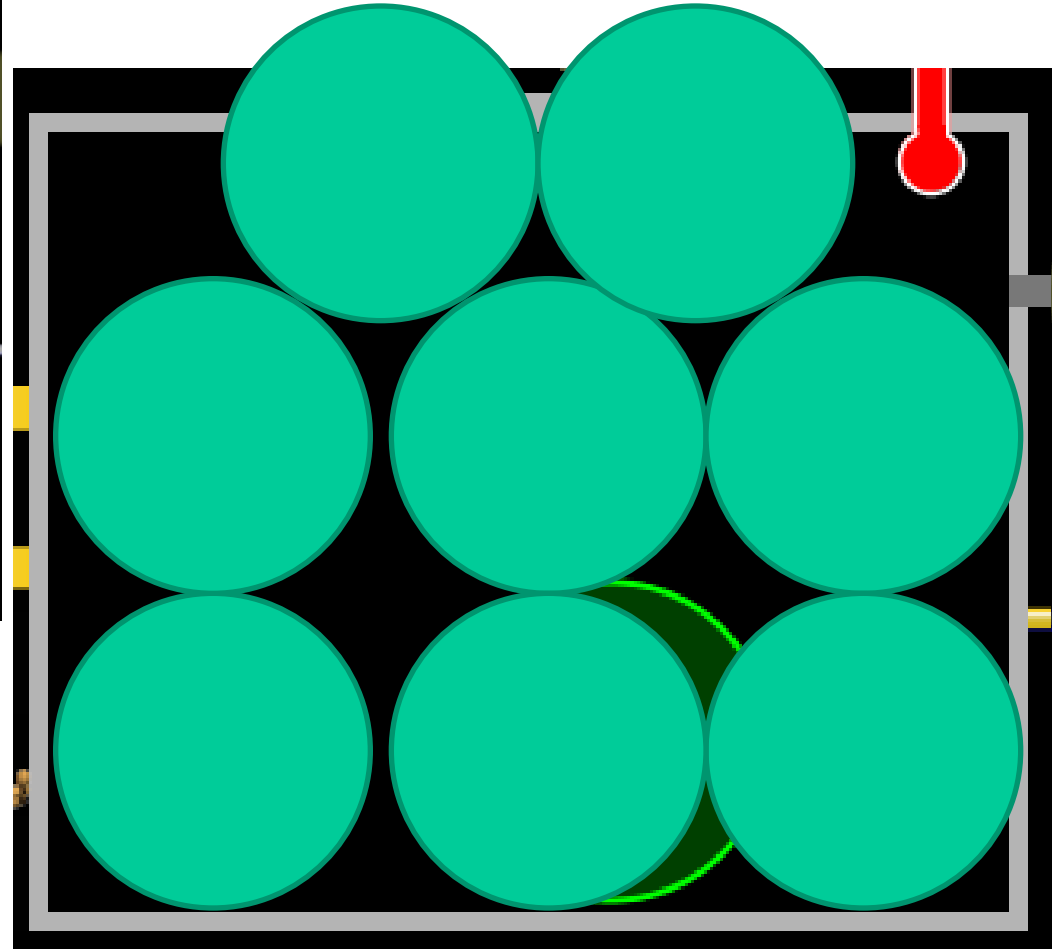
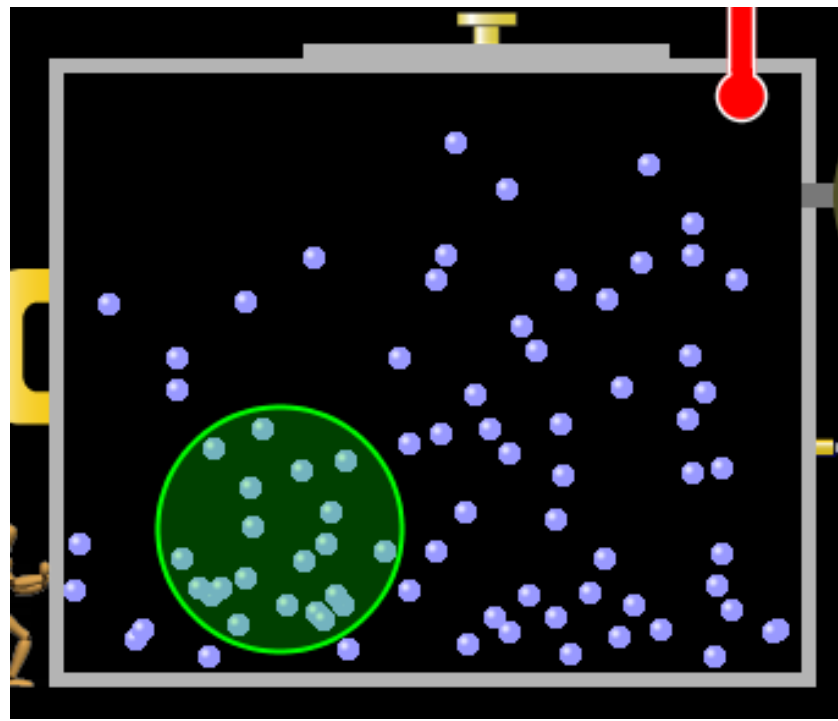

The container density would be about  $60/8 = 7.5$  and  $20/1$  because the box is about 8 times larger. The more dense sphere would sink

# What will the hydrogen balloon do?

- A. Expand and float
- B. Expand and sink
- C. Stay the same size and float
- D. Stay the same size and sink

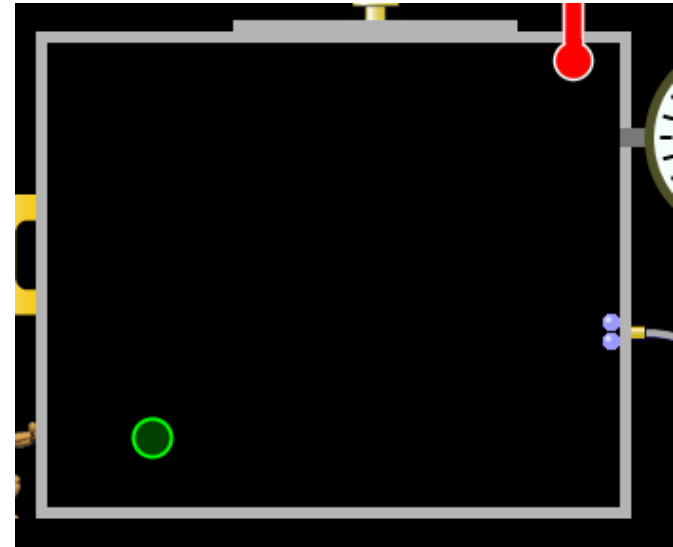

Gas in Chamber

Heavy Species	60
Light Species	0

Helium in Balloon

Number of atoms	20
-----------------	----

Gravity

0  Lots

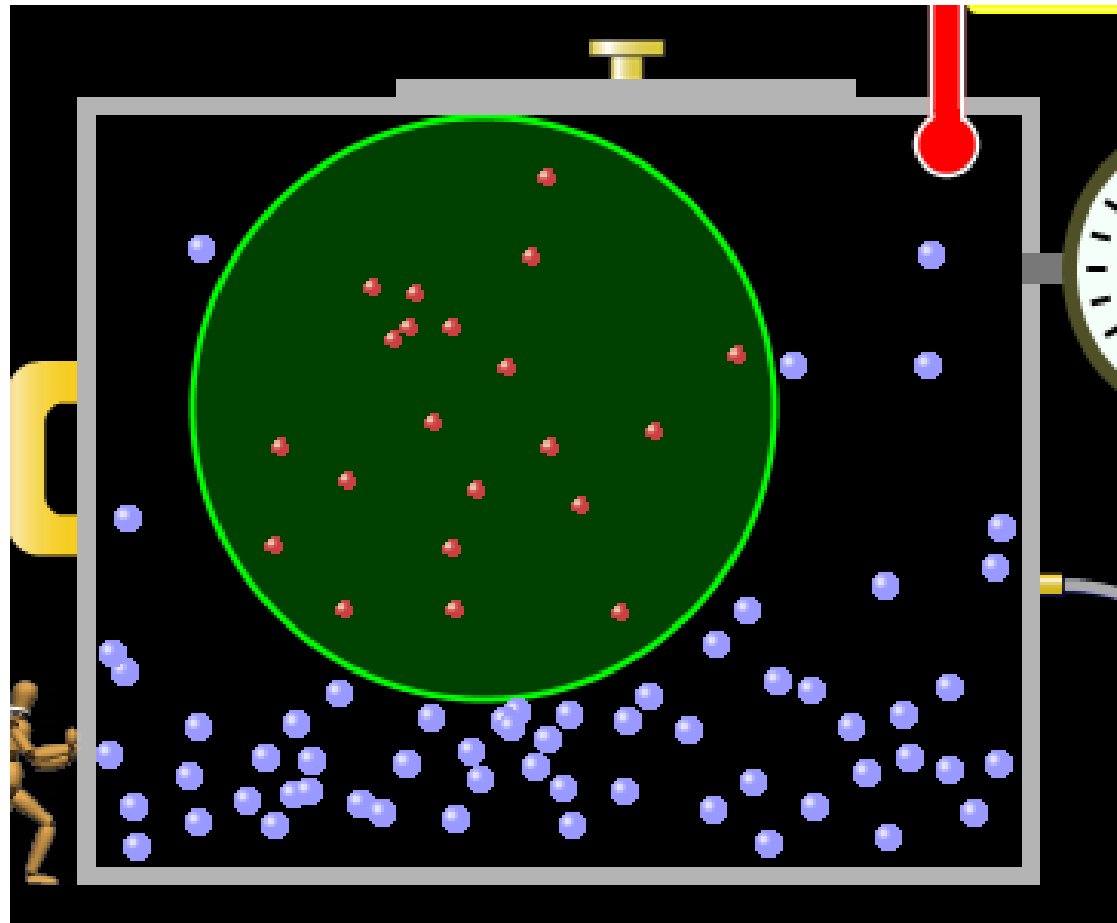

# What will the hydrogen balloon do?

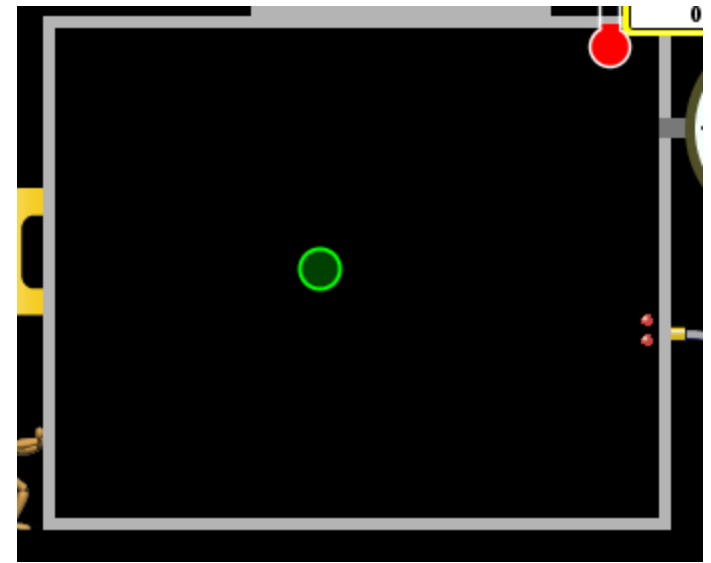

- A. Expand and float
- B. Expand and sink
- C. Stay the same size and float
- D. Stay the same size and sink

Gas in Chamber

Heavy Species	0
Light Species	300

Helium in Balloon

Number of atoms	20
-----------------	----

Gravity

0  Lots

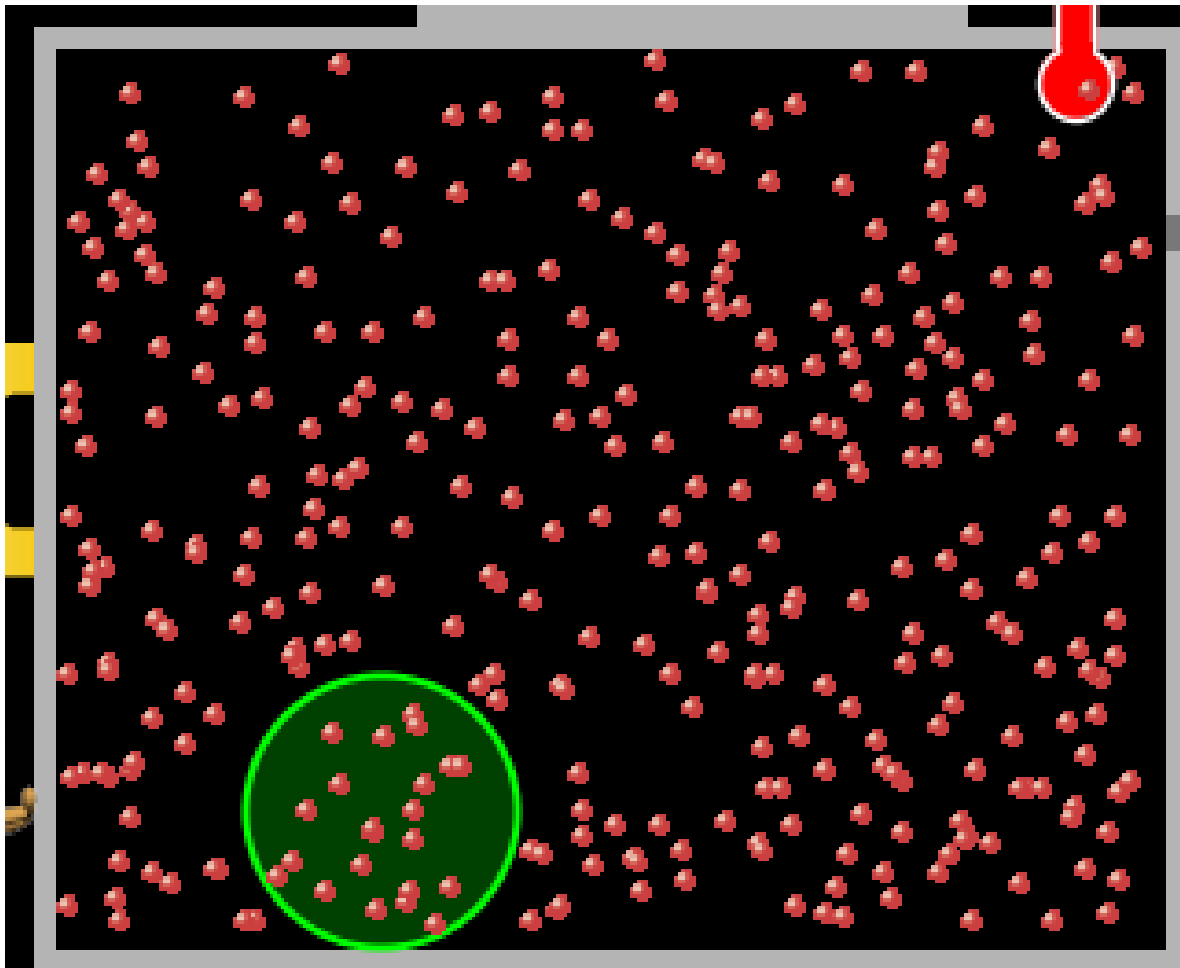

Discussion: Would the results be different if the outside molecules were the heavier species?

answer

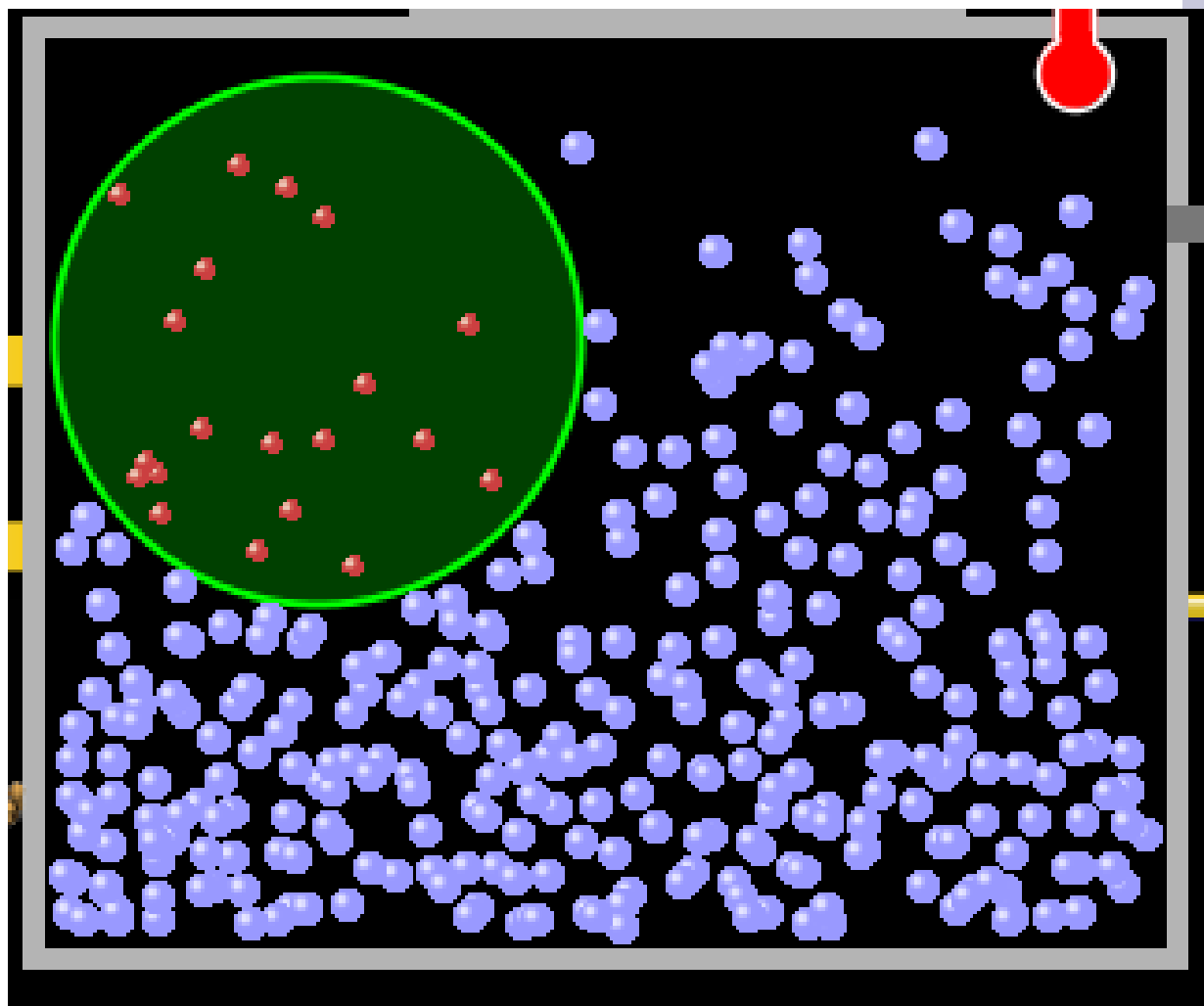

Gas in Chamber

Heavy Species

Light Species

Helium in Balloon

Number of atoms

Gravity

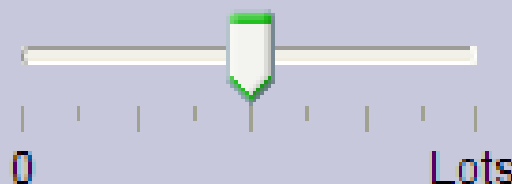

Tools & Options



Would you expect the hot air balloon to float or sink?

A. Sink

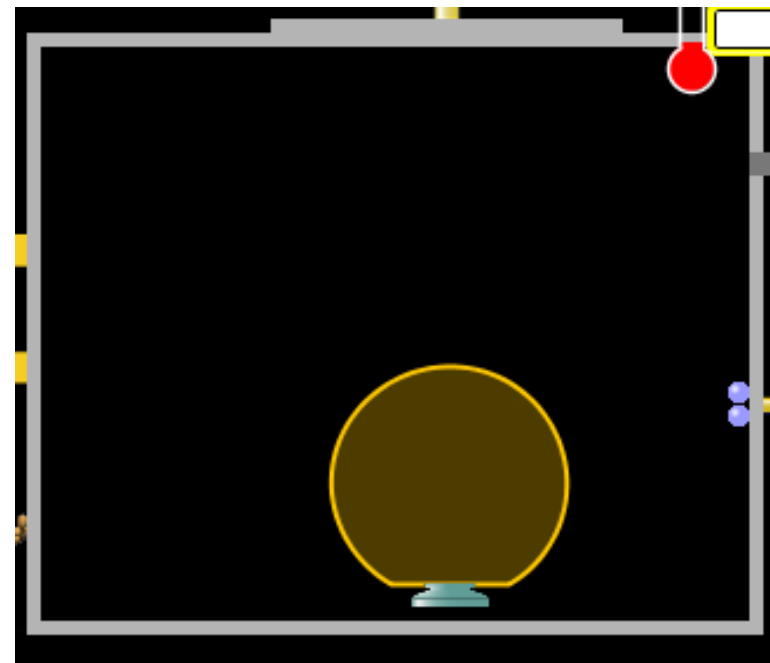

B. Float



Gas in Chamber

Heavy Species	61	-	+
Light Species	31	-	+

Hot Air Balloon

   Add  
0

Gravity



0 Lots

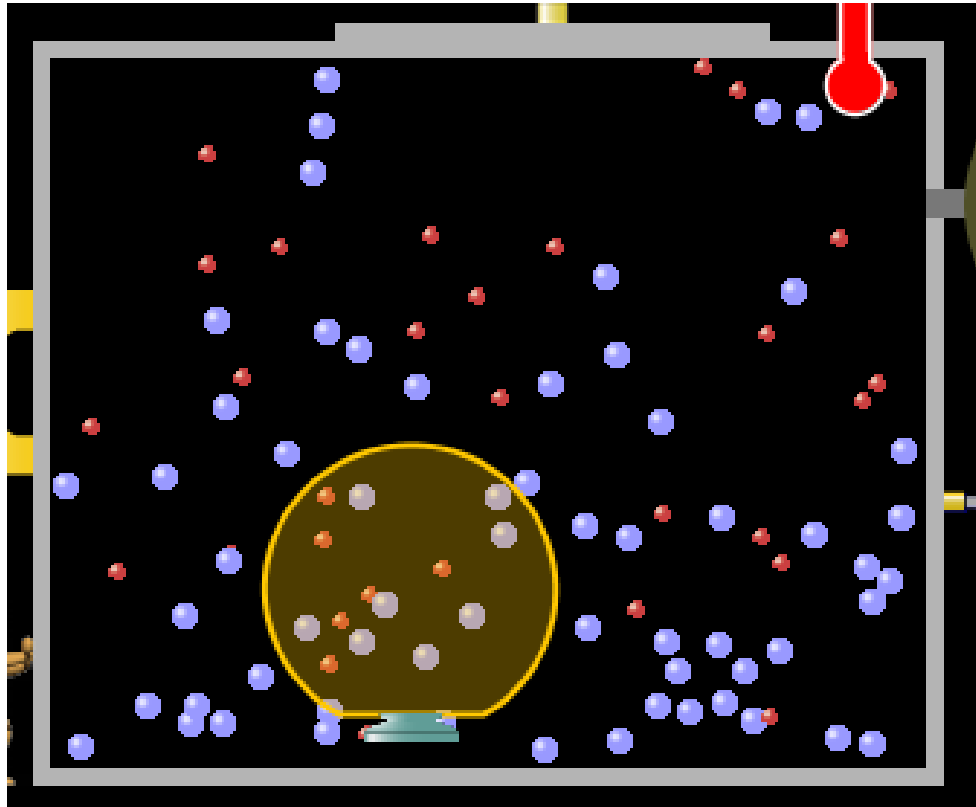

Discussion: Would there be a molecular combination that would allow the balloon to float?

Why did the hot air balloon float after the heater was used?

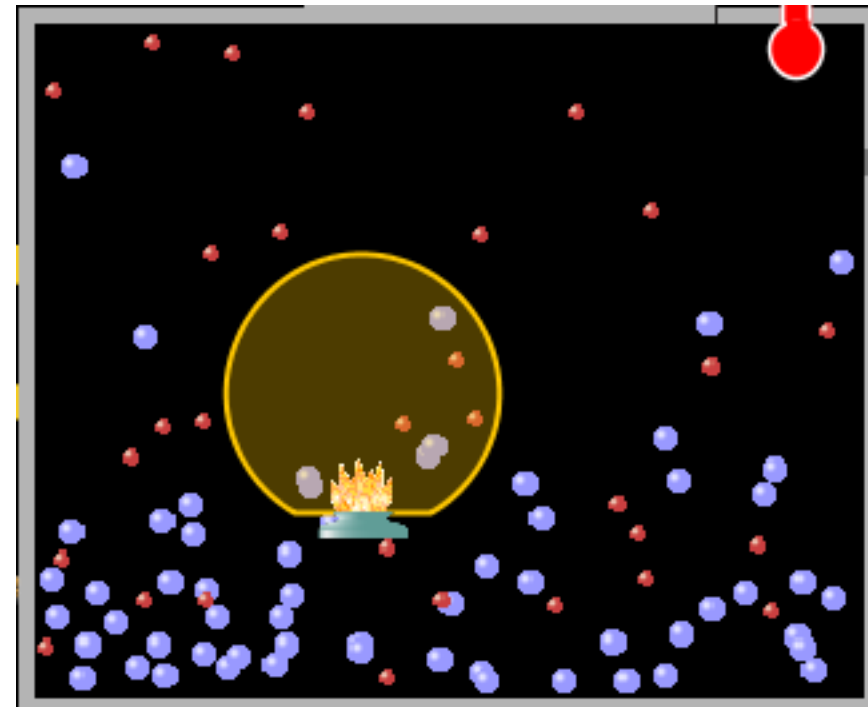
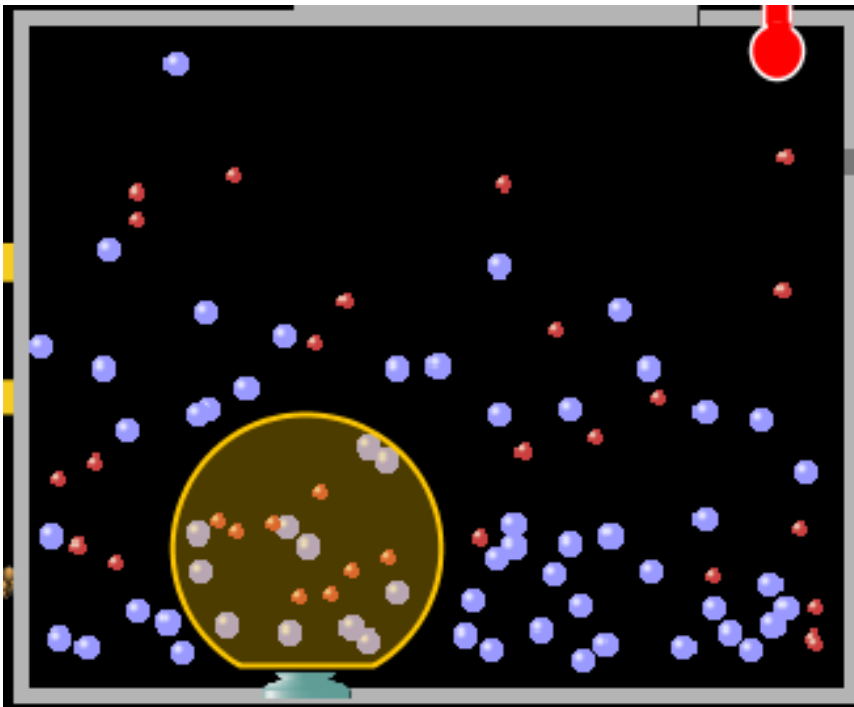

Discussion question

# Ladybug Motion 2D

**Learning Goals:** Students will be able to draw motion vectors (position, velocity, or acceleration) for an object is moving while turning.

Open *Ladybug Motion 2D* and *Ladybug Revolution* before starting the questions.

Trish Loeblein July 2009

1. What could the **position** and **velocity** vectors look like?

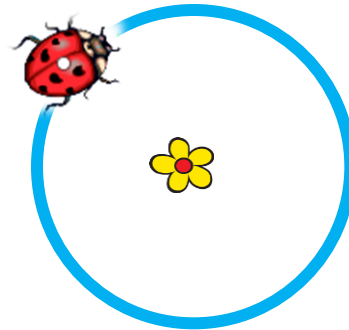

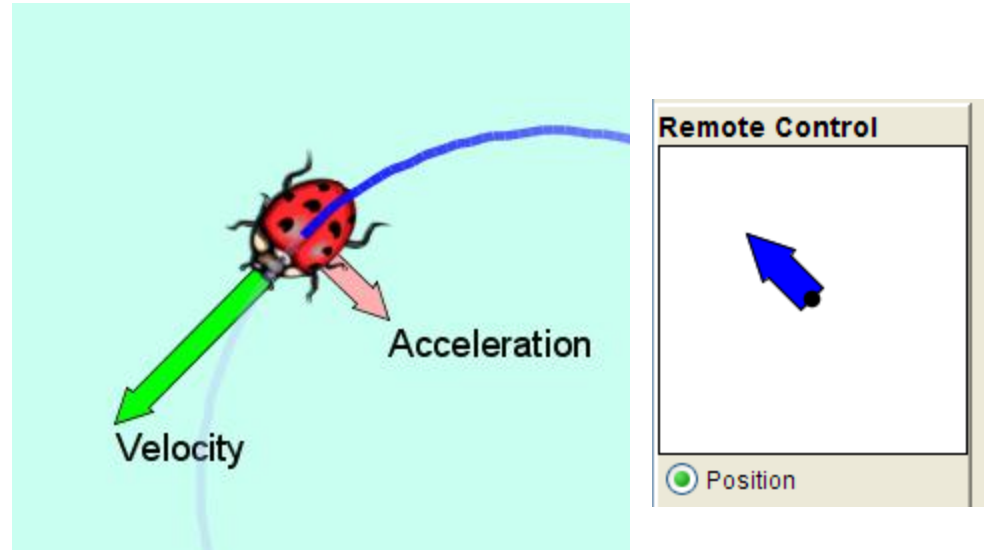
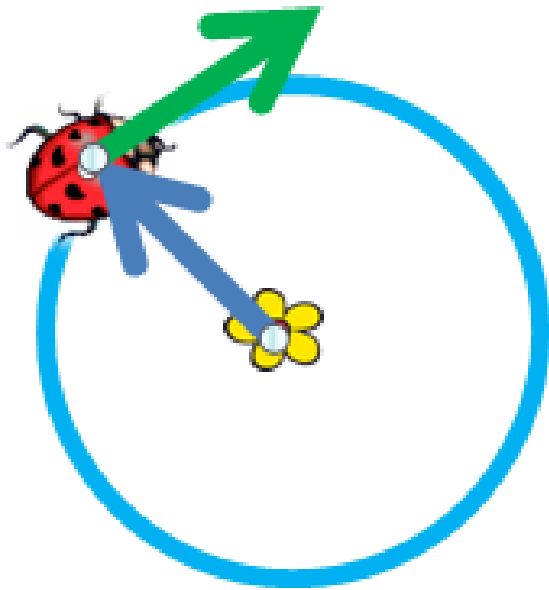

You could run the sim and discuss that in this situation the bug is traveling clockwise as opposed to counter clockwise in the sim. The velocity vector could be a different length depending on speed, but that the direction is correct.

2. What could the **acceleration** and **velocity** vectors look like?

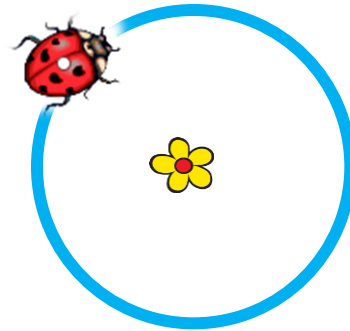

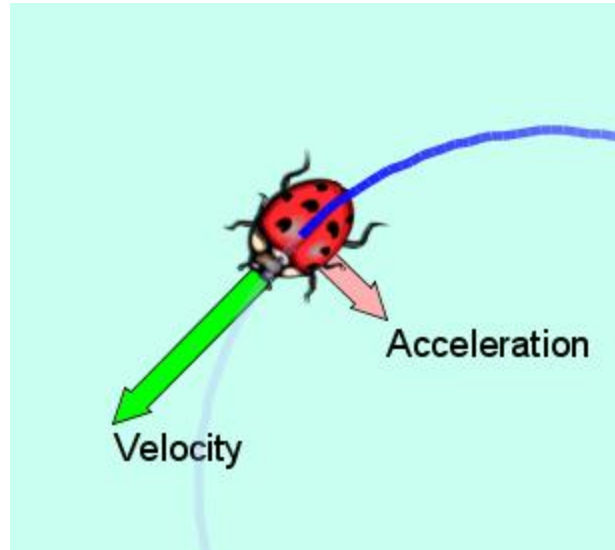
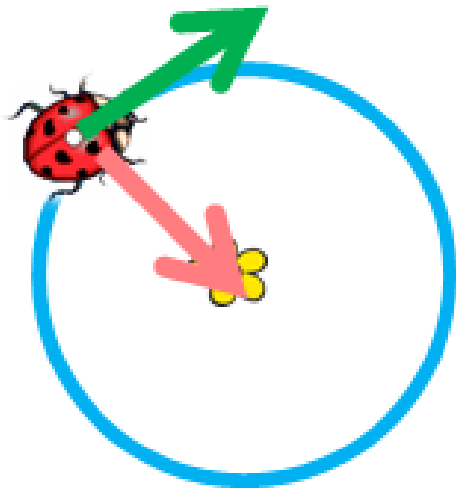

You could run the sim and discuss that in this situation the bug is traveling clockwise and that speed affects both velocity and acceleration vector length, but that the direction is correct.





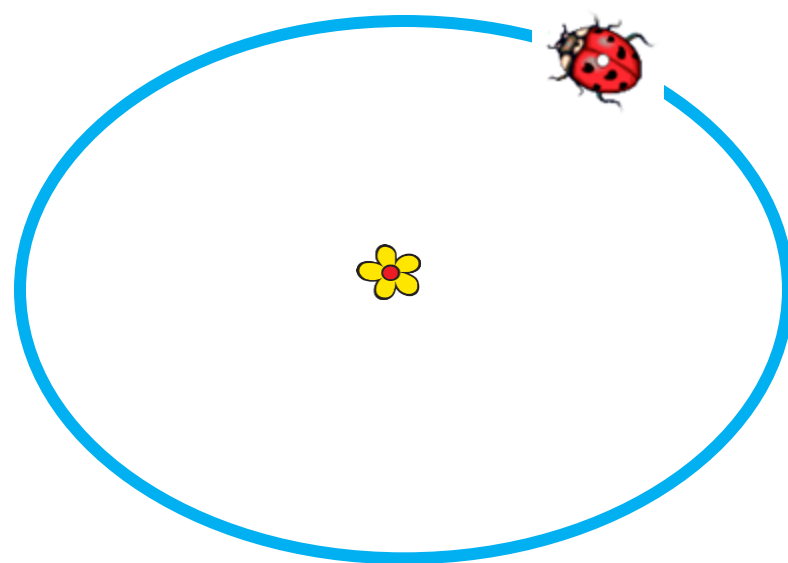
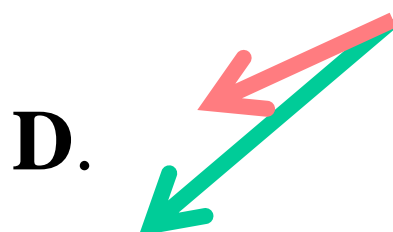
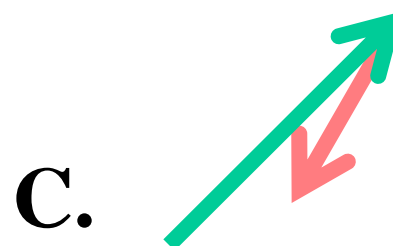
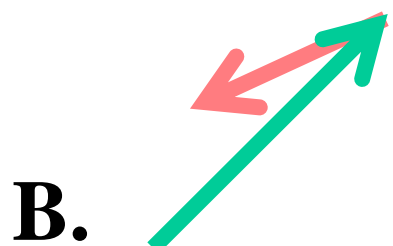
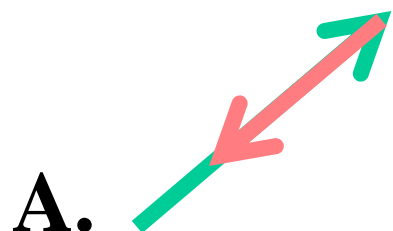

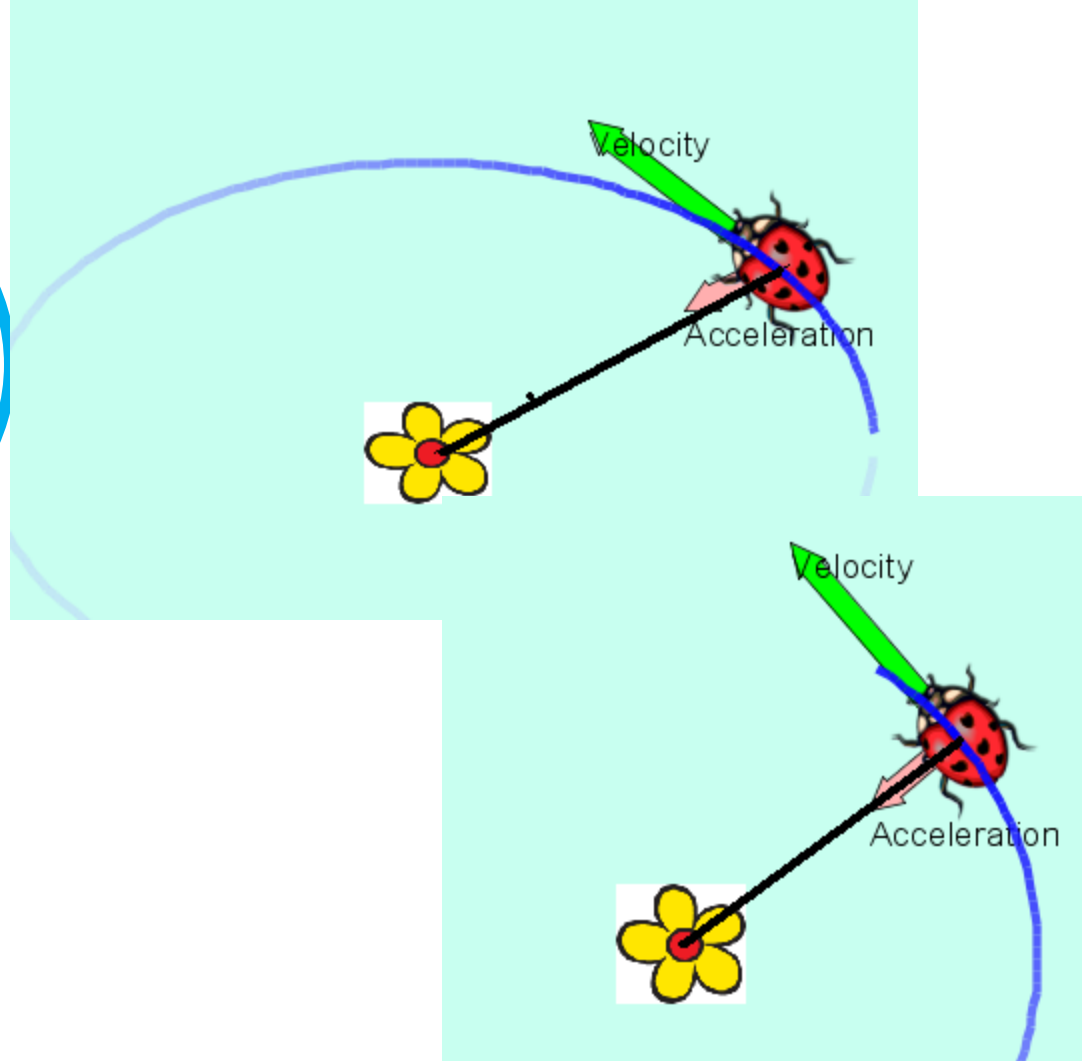
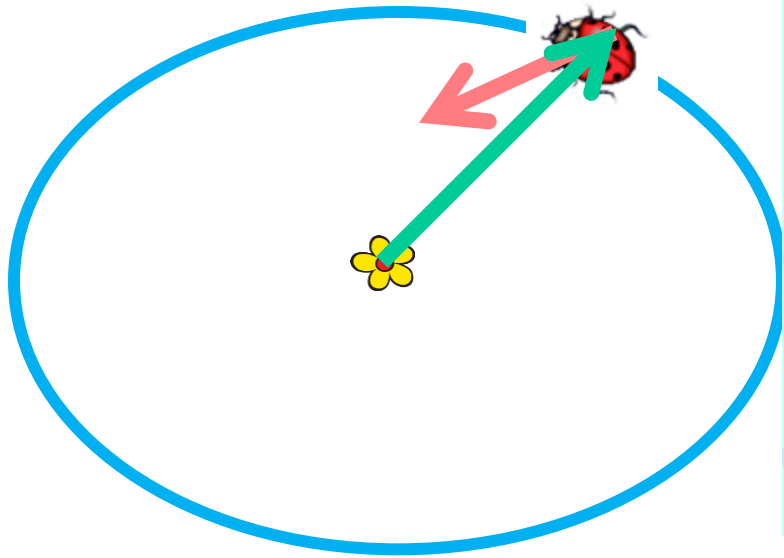

3. What could the **position** & **acceleration** vectors look like?





The acceleration would not be radial or the path would be circular. This is very difficult to see in the sim.

4. If you had two bugs moving in circles like this, what could the **velocity** vectors at point X vs point Y look like?

	X	Y
A		
B		
C		
D	Any of the above	
E	None of the above are possible	

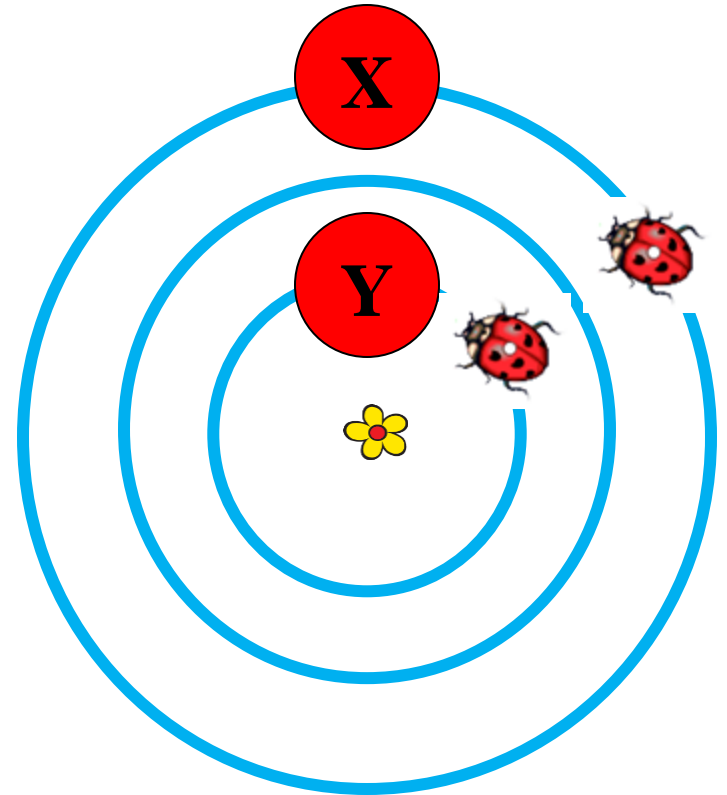

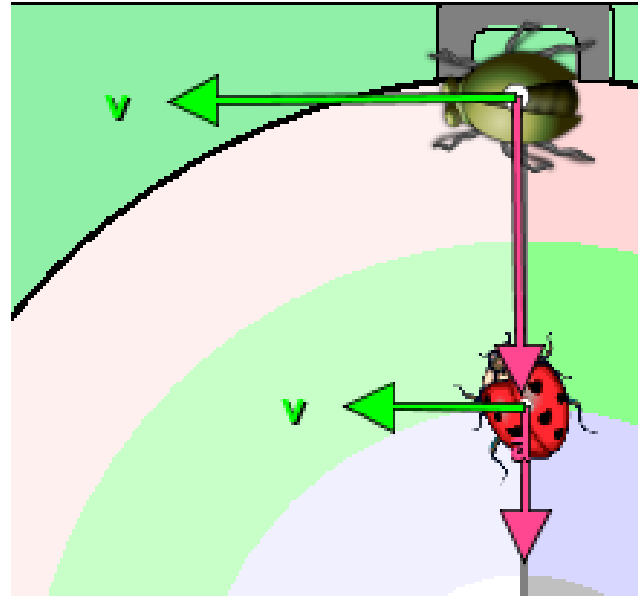
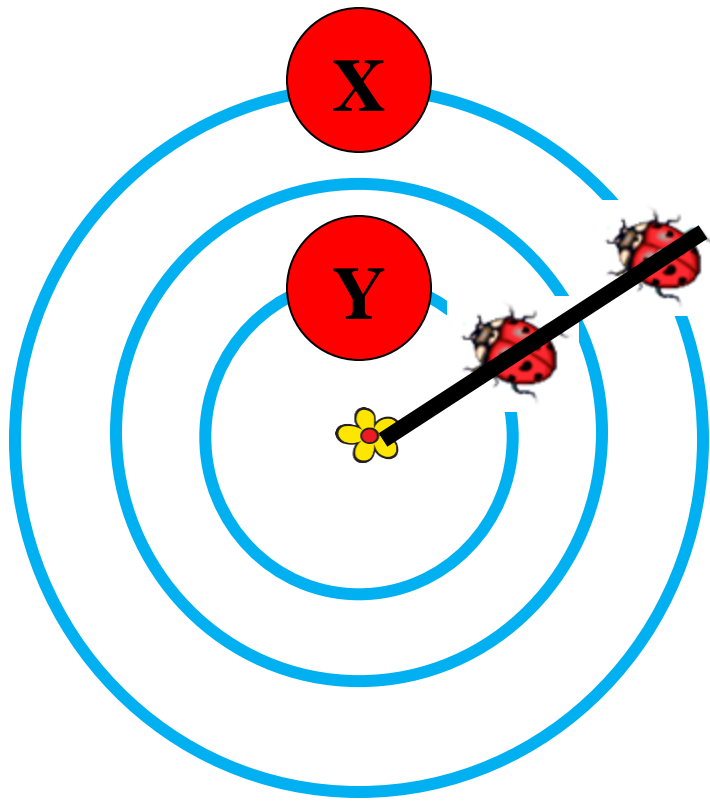

IF they were connected with a bar so they had to go around together, it would be like in Ladybug Revolution, but otherwise there is no way to know the vector length relationship, but the vectors would be parallel. I am thinking that the bugs might arrive at X and Y at different times.

# Calculus Grapher for Physics

**Learning Goals:** Students will be able to:

- Use the language of calculus to discuss motion
- Given a function sketch the derivative, or integral curves

Open *Calculus Grapher* and *Moving Man* before starting presentation

Trish Loeblein July 2009



1. A car started from a stoplight, then sped up to a constant speed. This function graph describes his..

A. Position

B. Velocity

C. Acceleration

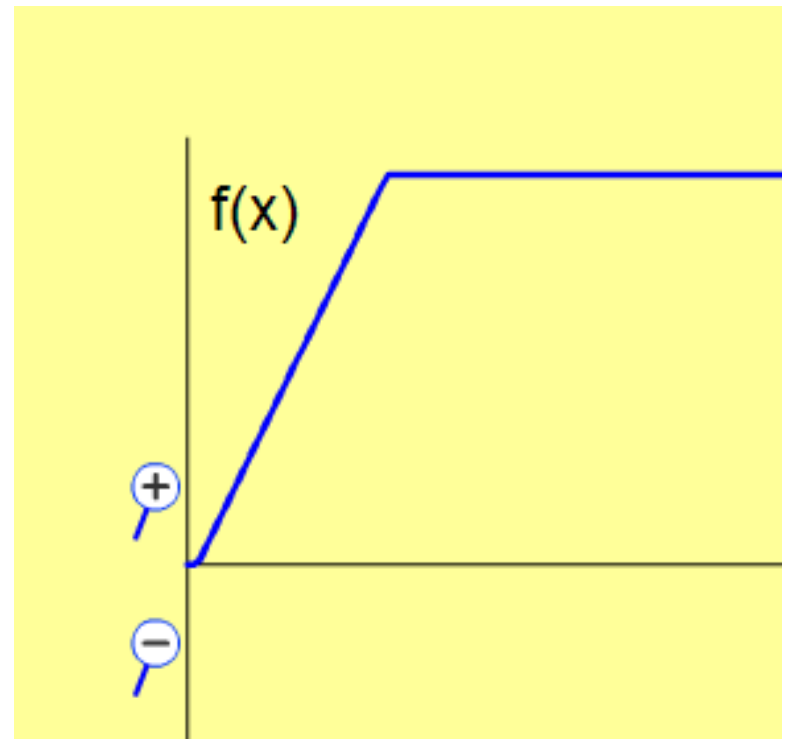

Use Moving man to show this: I set the acceleration at about 3 then paused the sim by the time the man got to the 4 spot, then I changed the acceleration to 0. If you have Moving man open with this type of scenario, you can use the grey bar to show that the speed was zero increasing and then constant.

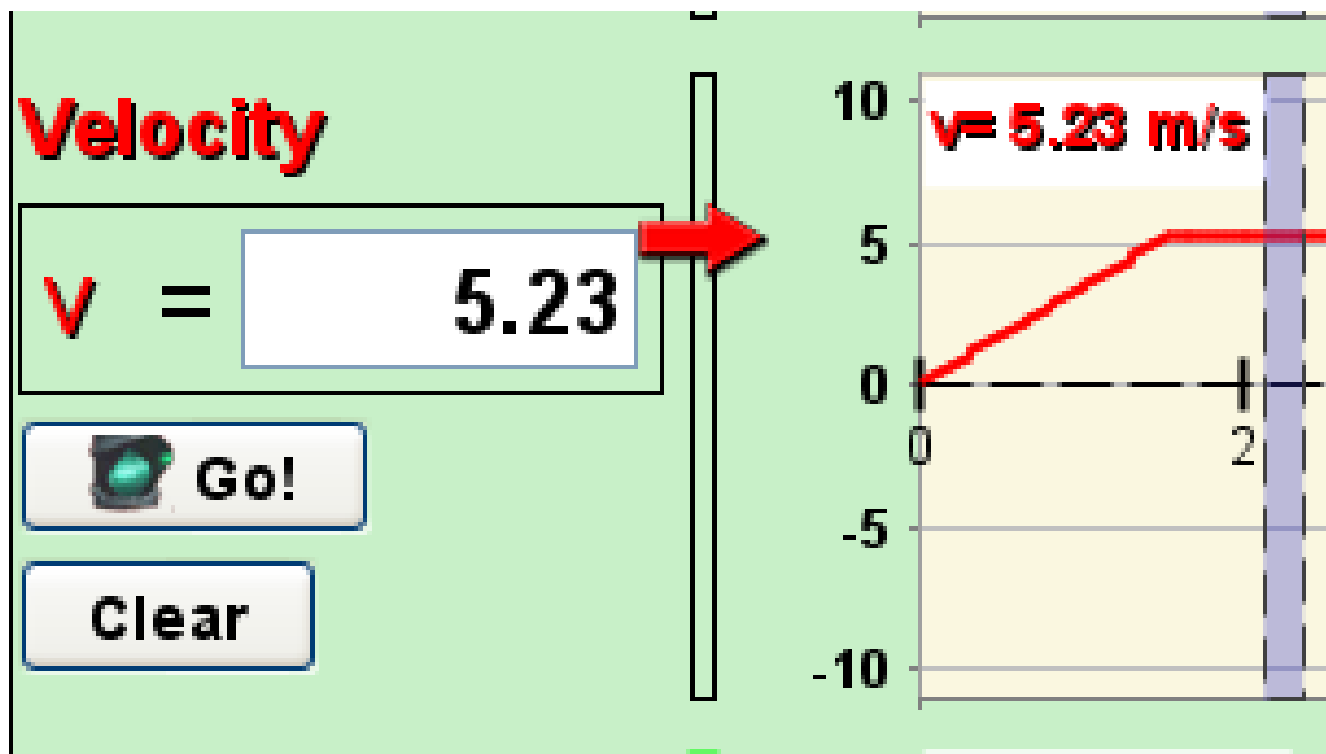



2. To find out how far he traveled, you would use

A. Integral

B. Function

C. Derivative

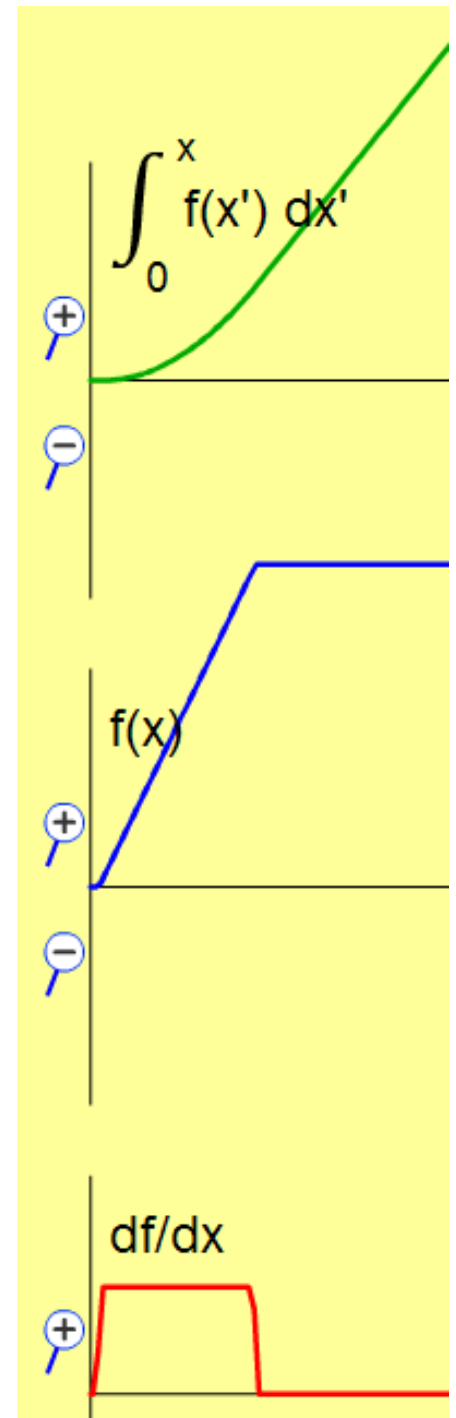



Use Moving Man **Replay** to show **Position** is found by the **integral** curve

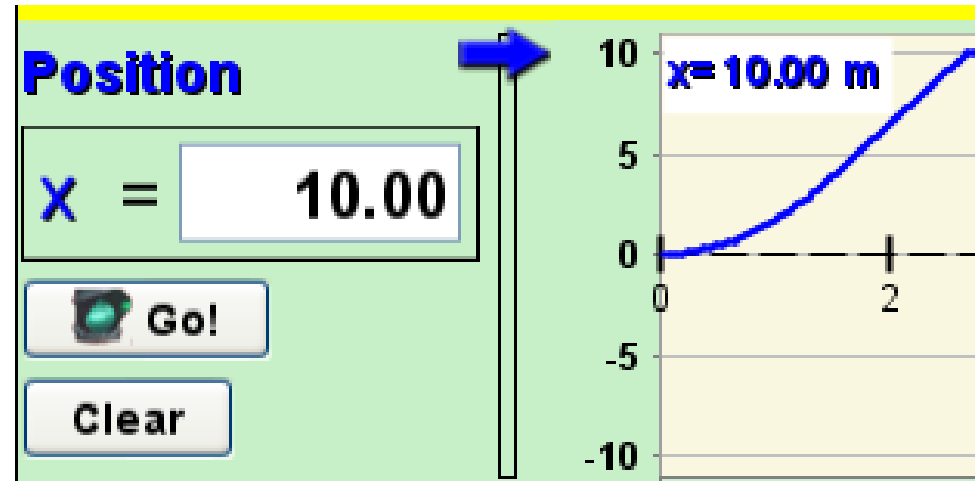
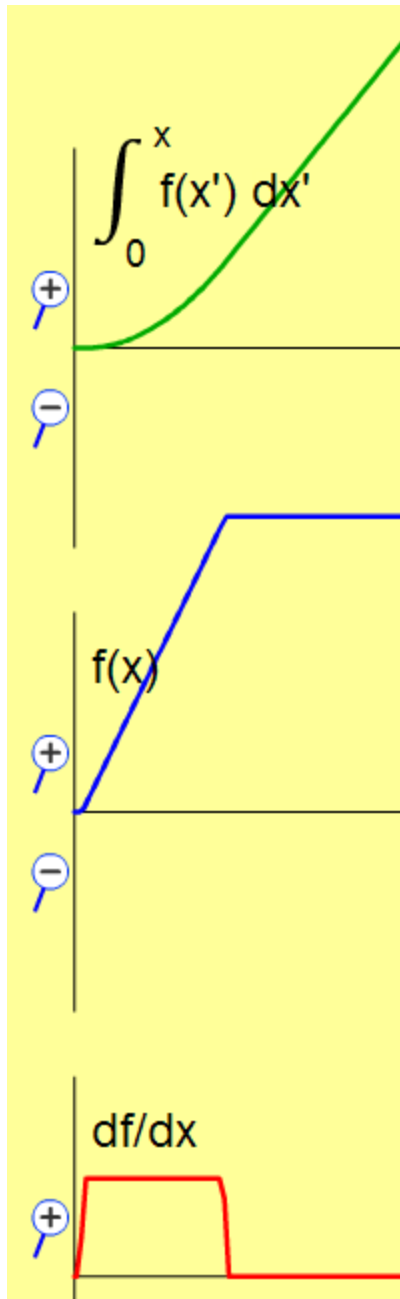

Derivative curve shows acceleration

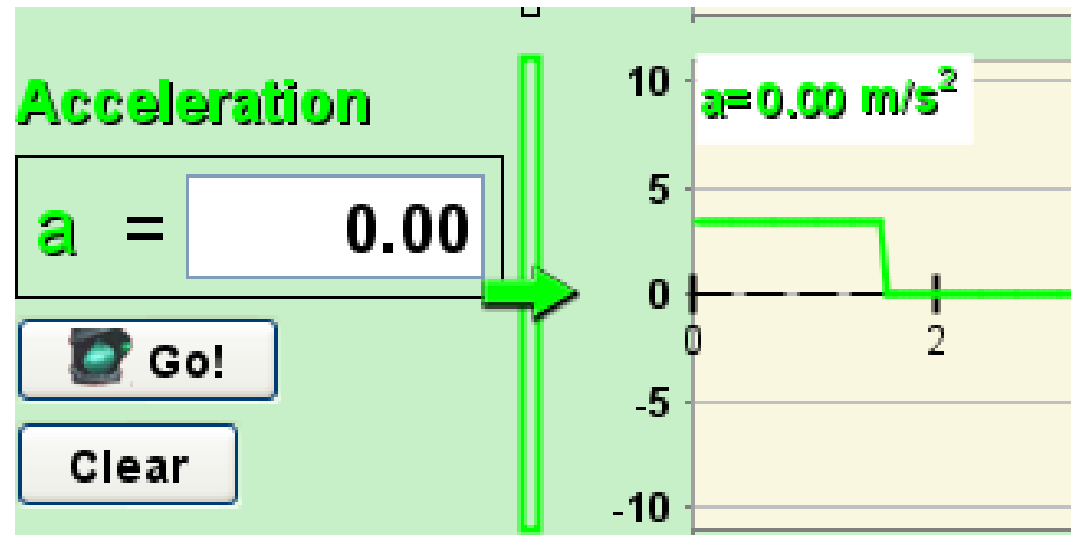

3. Your friend walks forward at a constant speed and then stops. Which graph matches her motion?

A. Position curve

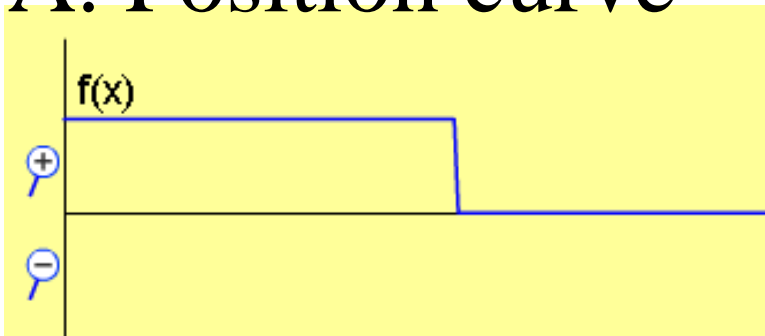

B. Velocity curve

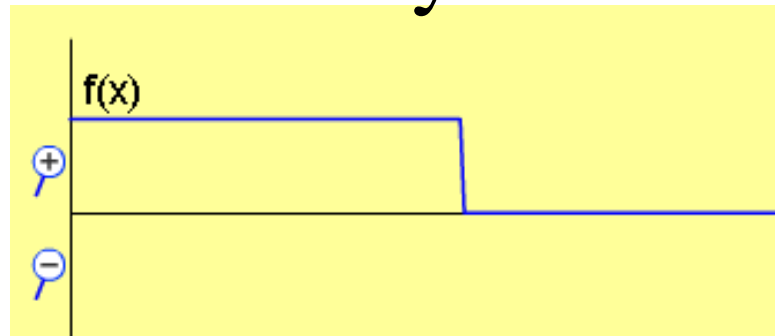

C. Position curve

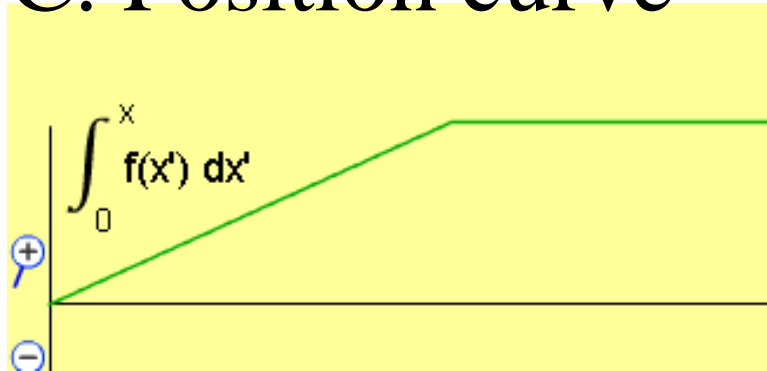

D. Acceleration curve

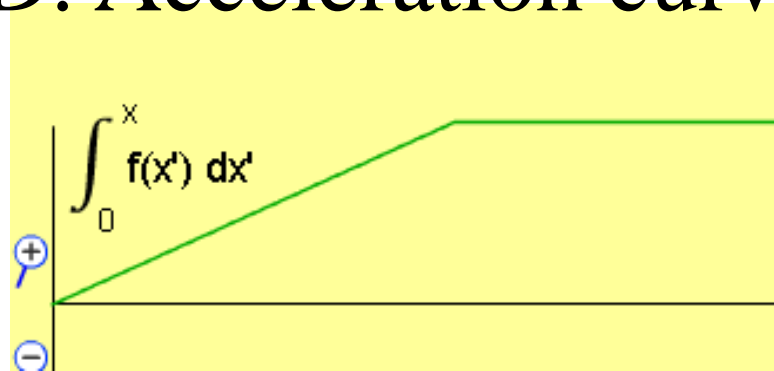

E. More than one of these

Use Moving man to show this: I set the Man at about -6 position, made the velocity about 4, then paused the sim by the time the man got to the 4 spot, then I changed the velocity to 0. If you have Moving man open with this type of scenario, you can use the grey bar to help.

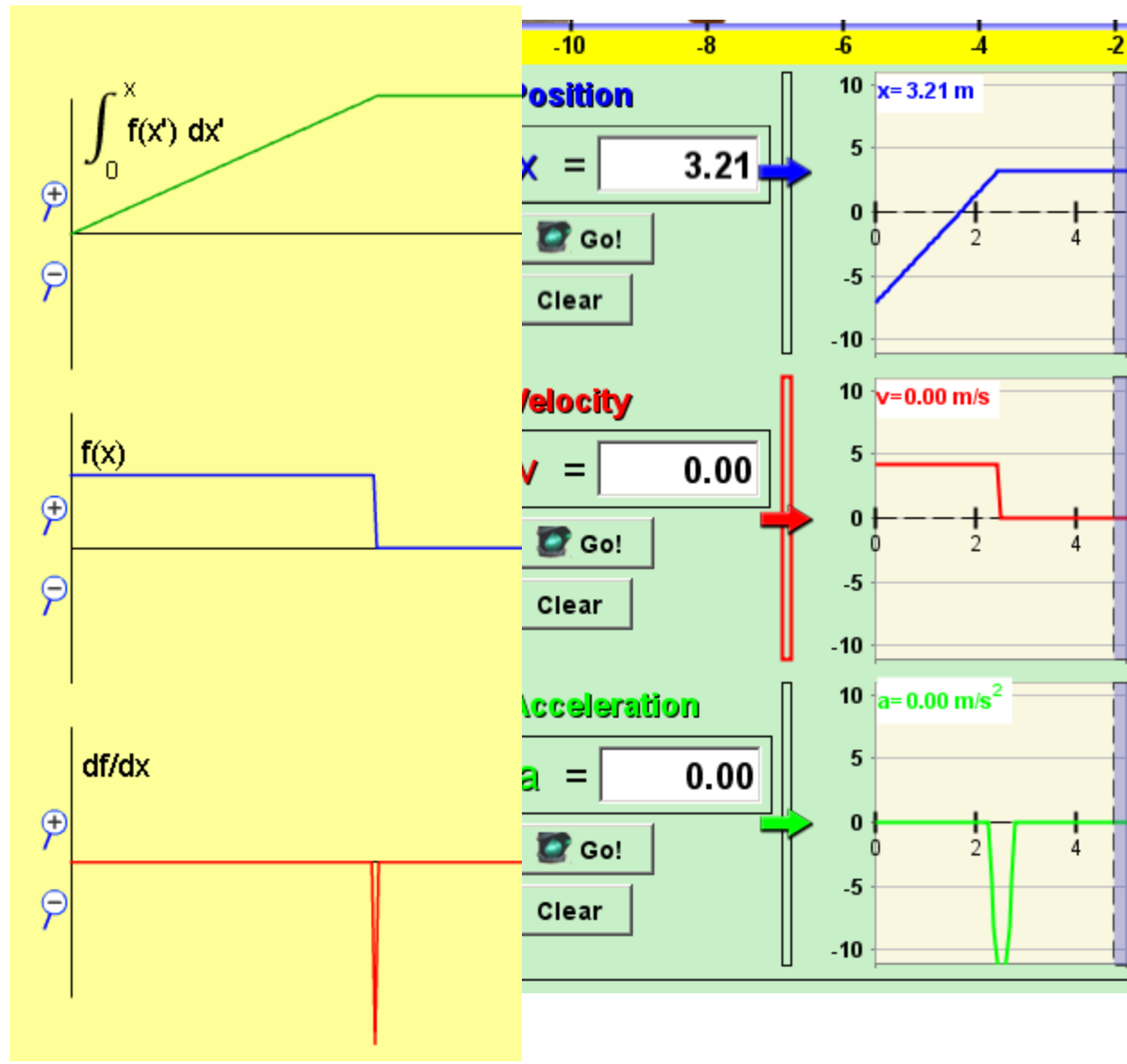

4. Which could be the derivative curve?

$F(x)$

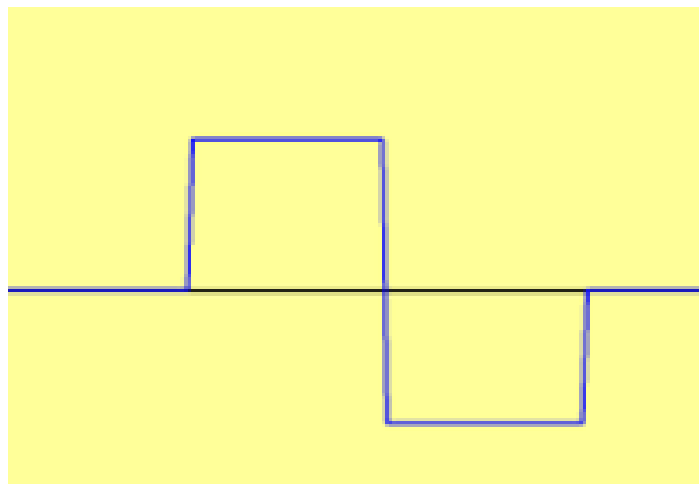

**A**

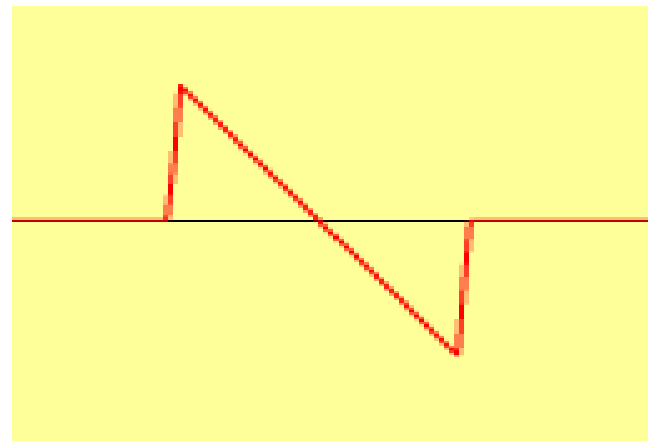

**B**

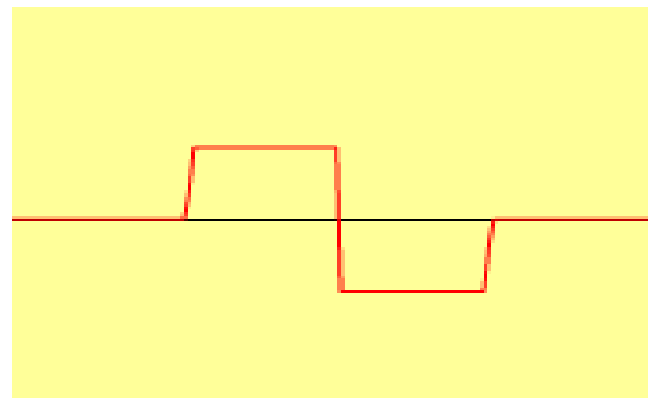

**C**

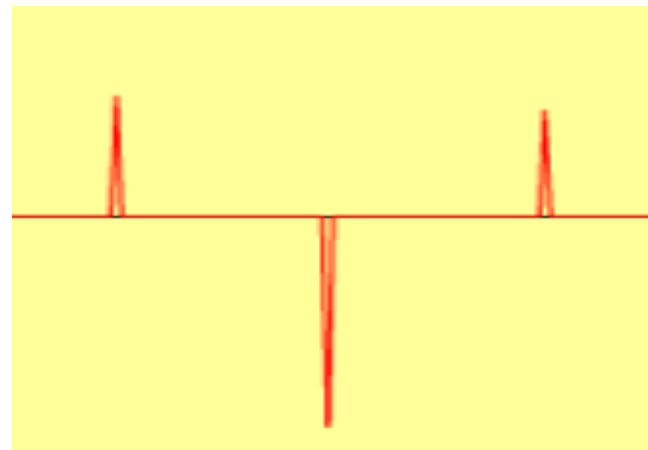

# Pedestal

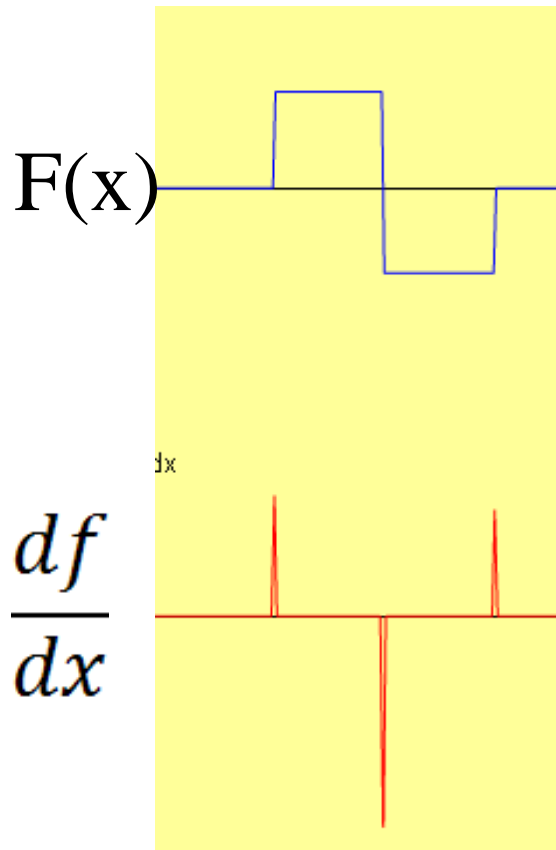

# Linear

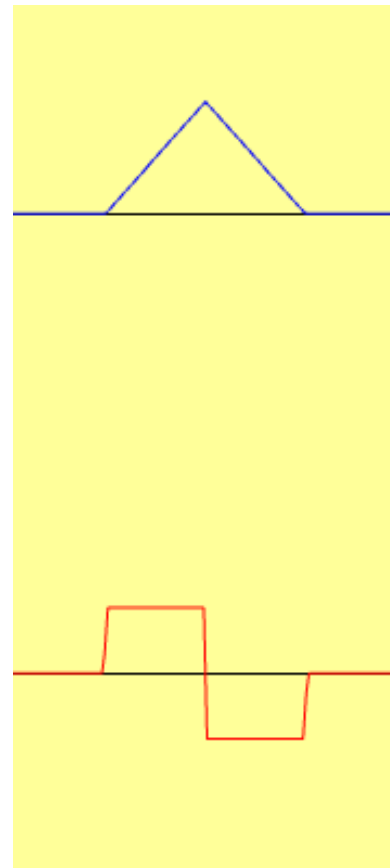

# Parabola

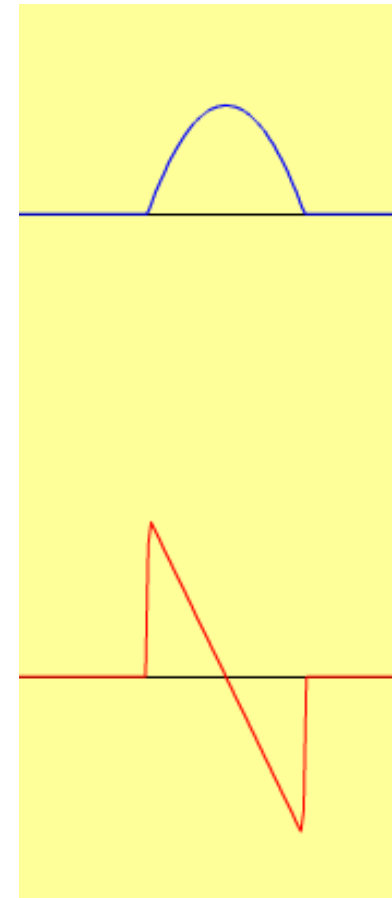

For each case, if the function,  $F(x)$  is velocity, what could a possible story for the motion of a person walking?

5. Three race cars have these velocity graphs. Which one probably wins?

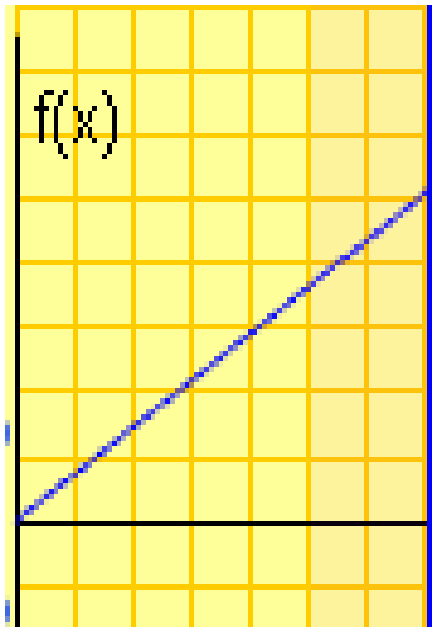
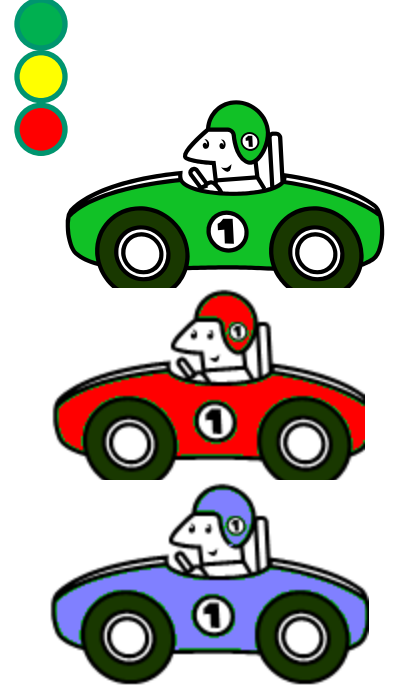

**A**

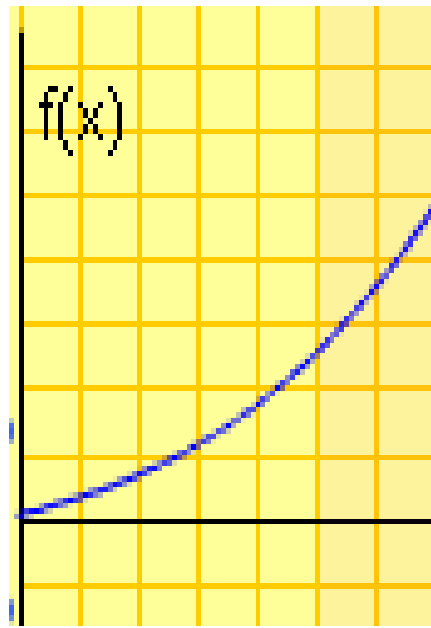

**B**

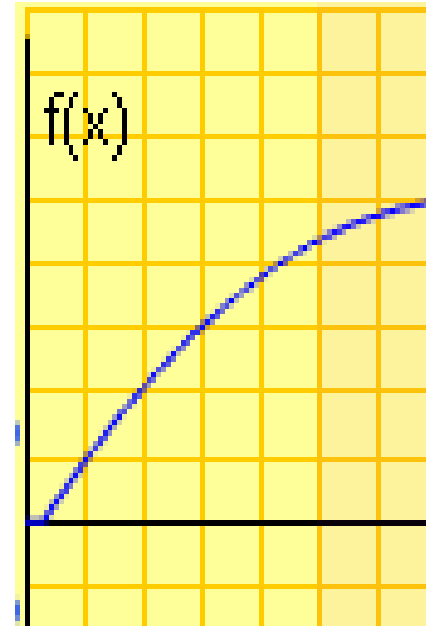

**C**

**D No way to tell**

**Max value**



Use integral to  
tell that the  
parabolic one  
traveled  
farthest

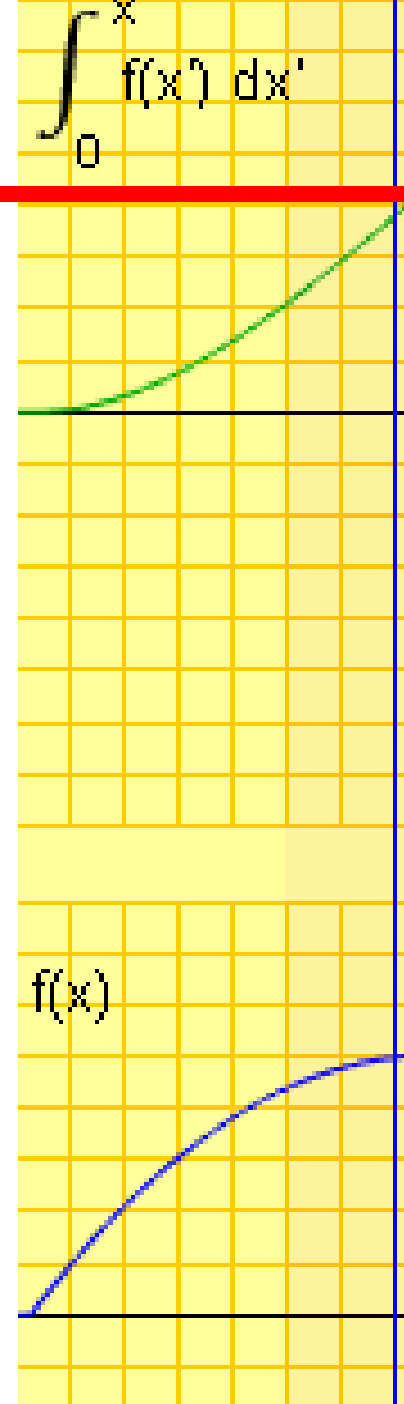
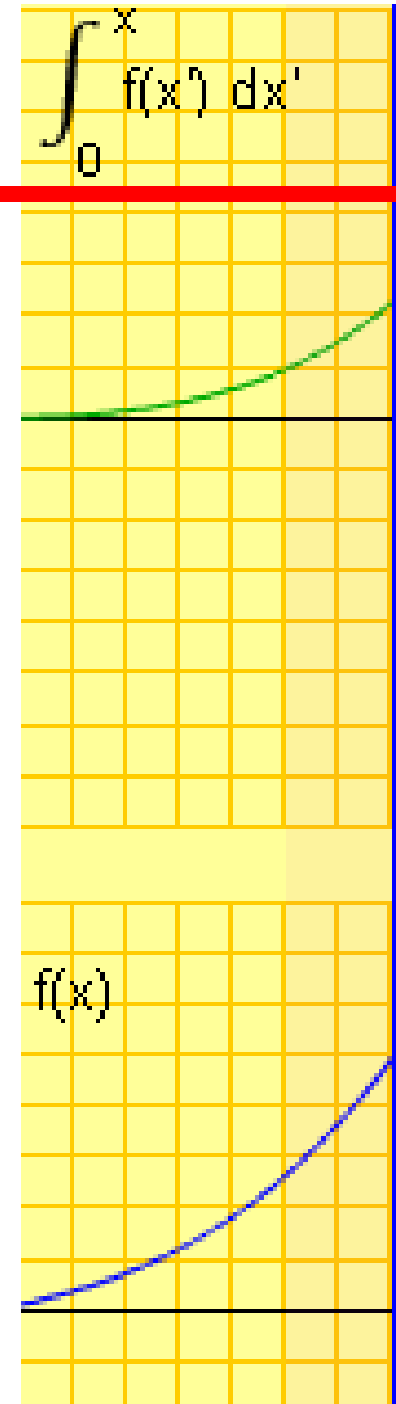
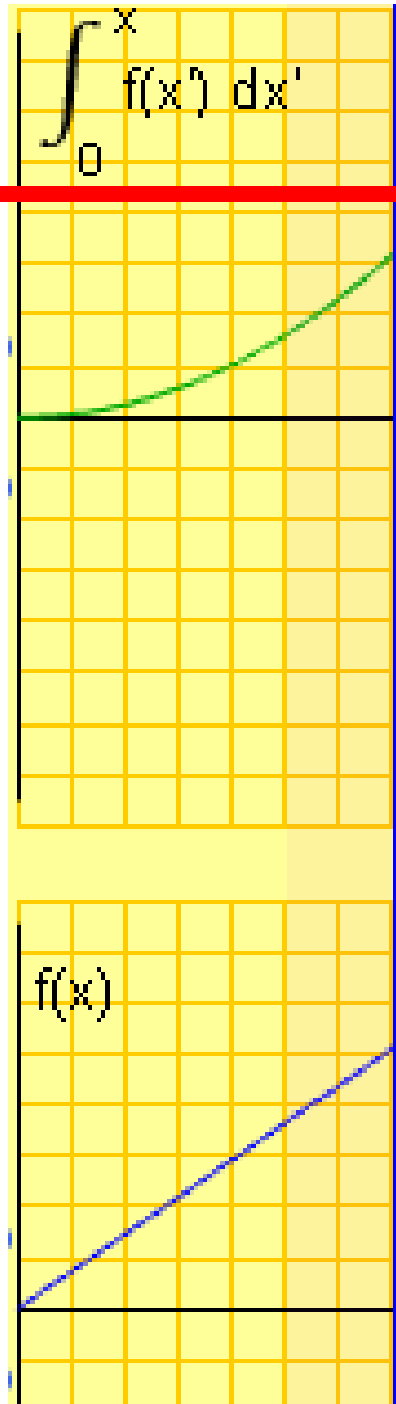

# Understanding KMT using *Gas Properties and States of Matter*

Trish Loeblein [phet.colorado.edu](http://phet.colorado.edu)

**Learning Goals: Students will be able to describe matter in terms of particle motion. The description should include**

- **Diagrams to support the description.**
- **How the particle mass and temperature affect the image.**
- **How the size and speed of gas particles relate to everyday objects**
- **What are the differences and similarities between solid, liquid and gas particle motion**



If you have a bottle with Helium & Nitrogen at room temperature, how do the speed of the particles compare?

- A. All have same speed
- B. The average speeds are the same
- C. Helium particles have greater average speed
- D. Nitrogen particles have greater average speed

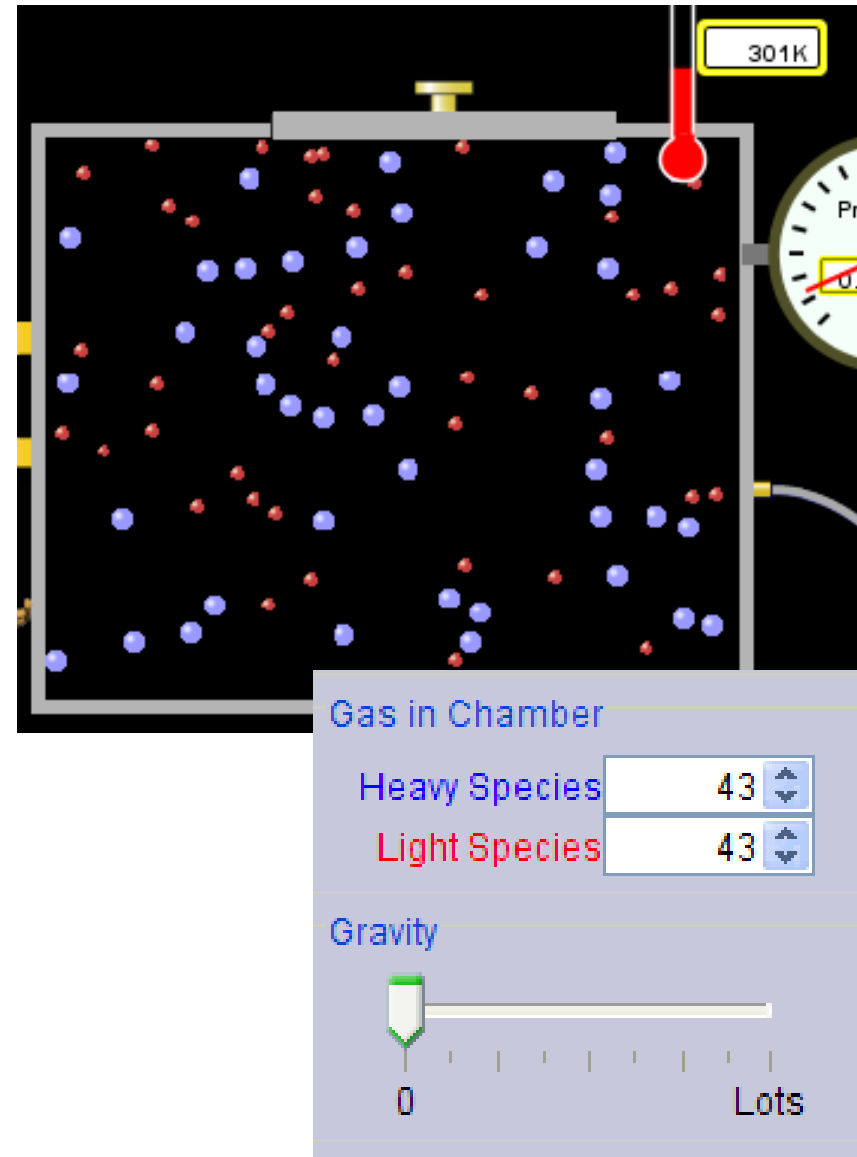

# Light and heavy gas at same temperature 300K

**Gas Properties**

Heavy species

Number of Gas Molecules: 43    Ave. Speed: 425.21 m/sec

Light species

Number of Gas Molecules: 43    Ave. Speed: 1,172.71 m/sec

Java Application Window

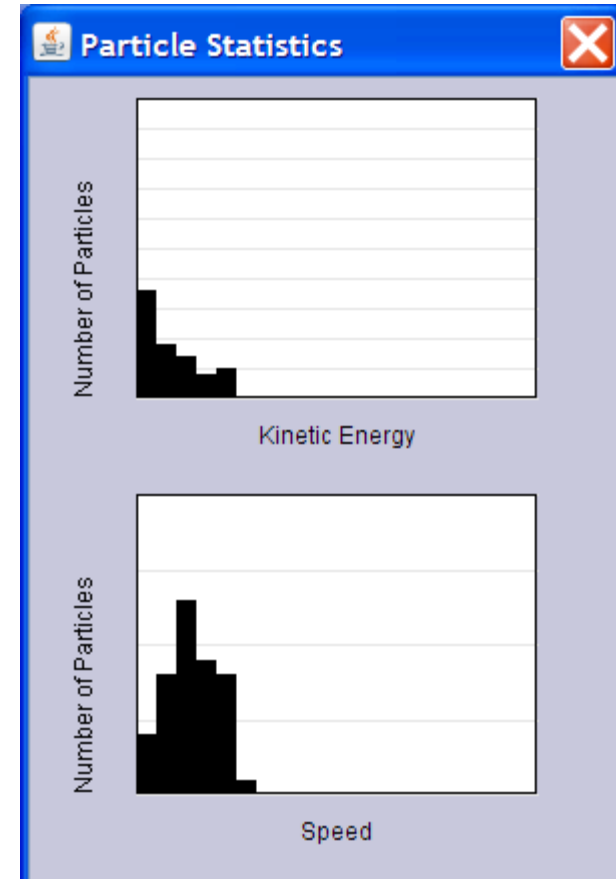

Speed of each particle varies!!

What happens if you add energy using the heater?



- A. All atoms speed up
- B. All atoms speed up about the same
- C. The lighter ones speed up more
- D. The heavier ones speed up more

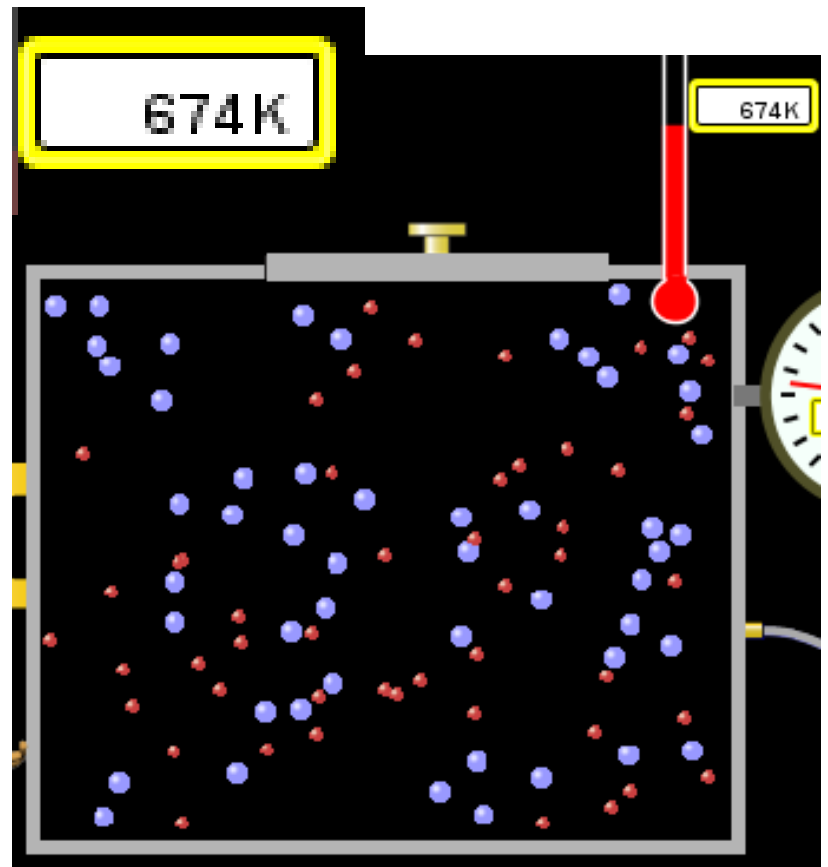
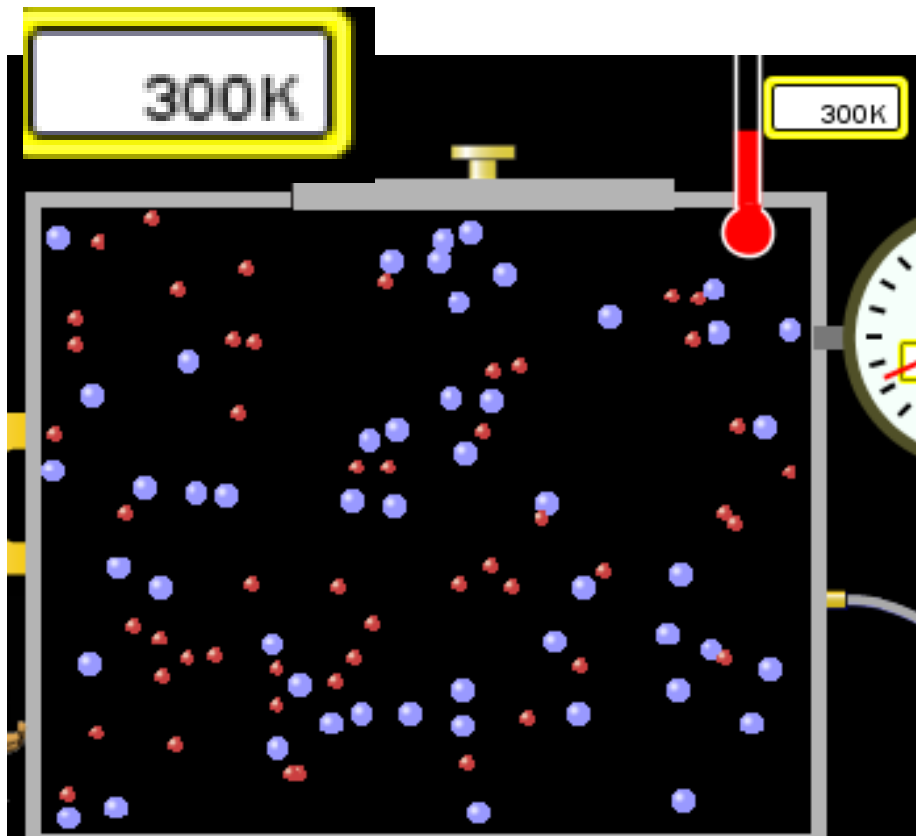

50 Ave. Speed: 411.96 m/sec

686.59 m/sec

50 Ave. Speed: 1,171.95 m/sec

1,516.18 m/sec

Which is most likely oxygen gas?

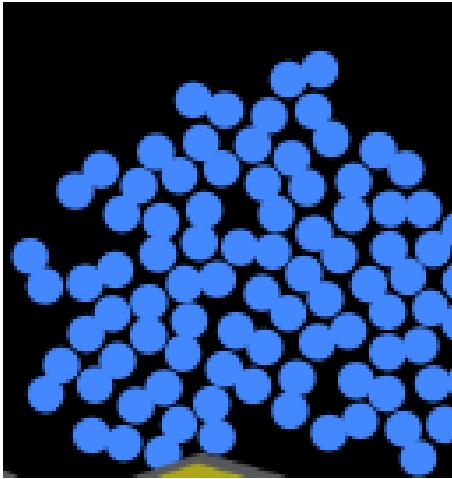

A

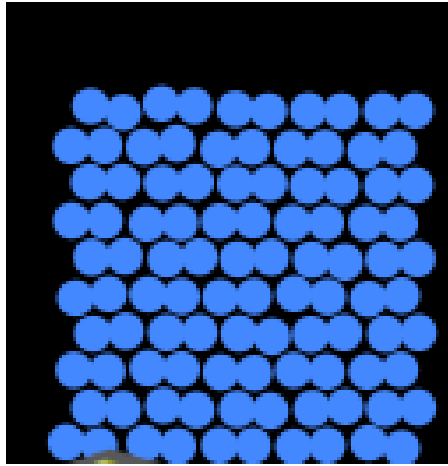

B

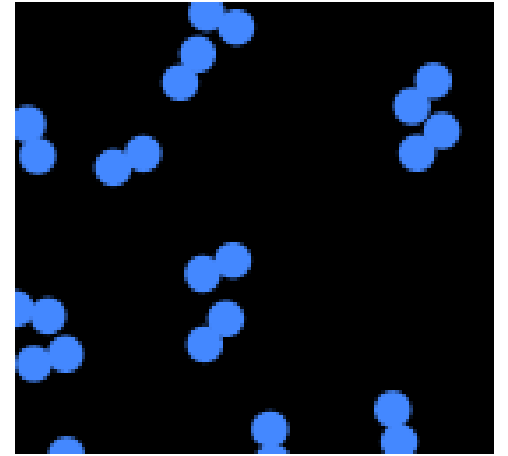

C

Which is most likely liquid water?

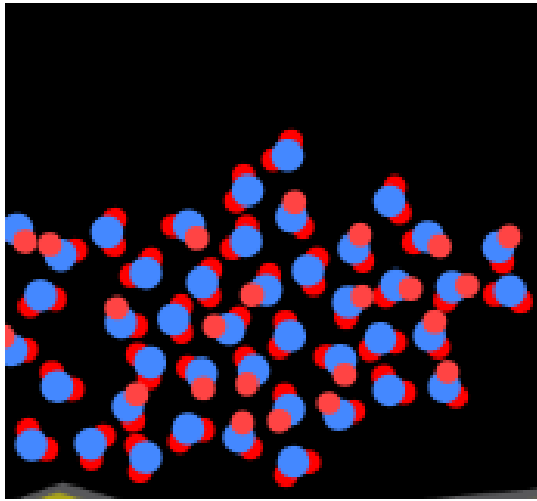

A

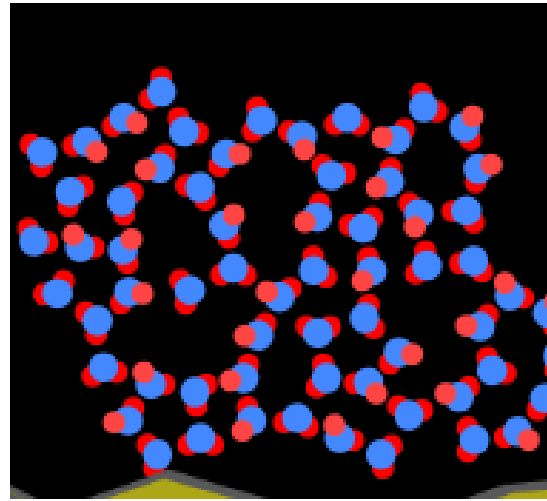

B

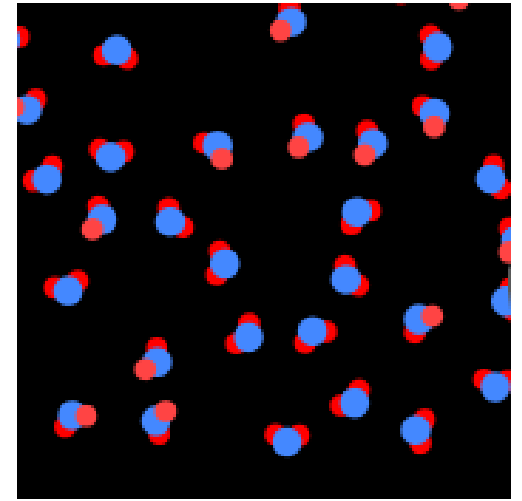

C

How many water molecules are in a raindrop(.5 cm diameter). *The molecules are about .1nm*

**If we just look at how many are across**

**.05m/.1E-9m = 5E7 or 50 million.**

# To show vibration

- <http://chemeddl.org/collections/molecules/index.php>
- Check **Spin Molecule** to see 3D rotation
- Show vibration under **Normal modes of vibration** (toggle down to see bond length changing)



# KMT summary:

- Matter is made up of particles having negligible mass are in constant random motion (vibrate, rotate, translate)
- The particles are separated by great distances
- The particles collide perfectly elastically (there are no forces acting except during the collision)
- The temperature of a substance is related to the molecular velocity.

# Circuit Construction Kit

## Clicker questions

**Three activities by Trish Loeblein**  
**[phet.colorado.edu](http://phet.colorado.edu)**

- 1. Introduction to Electrical circuits**
- 2. Resistors in Series and Parallel Circuits**
- 3. Combo Circuit Lab**

# Introduction to Electrical circuits

**Learning Goals: Students will be able to**

- 1. Discuss basic electricity relationships**
- 2. Analyze the differences between real circuits and the simulated ones**
- 3. Build circuits from schematic drawings**
- 4. Use a multimeter to take readings in circuits.**
- 5. Provide reasoning to explain the measurements and relationships in circuits.**

1. If you build this circuit with real equipment, how would you determine the resistance of the resistor?

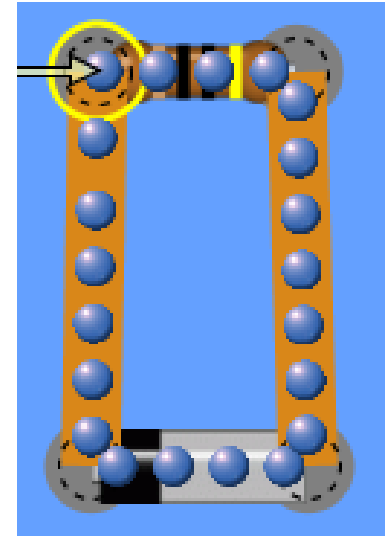

- A. Use the ohmmeter after connecting the battery.
- B. Use the ohmmeter before connecting the battery.
- C. Measure the current and voltage, then use Ohm's law
- D. Two of the above.

2.If you increase the voltage of the battery, how will the light bulb change?

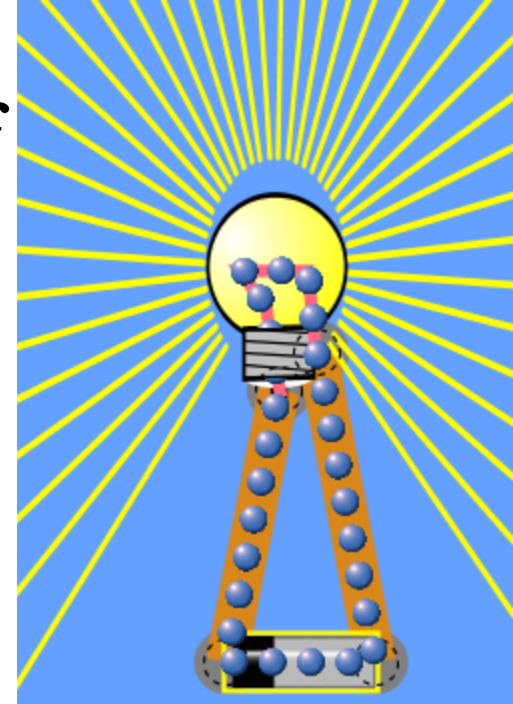

- A. It will be look brighter because the yellow lines are brighter and longer
- B. It will be less bright because the yellow lines are less bright and shorter
- C. There is no change because the bulb just uses the extra energy without changing brightness

3. If you increase the voltage of the battery, how will the electron display  change?

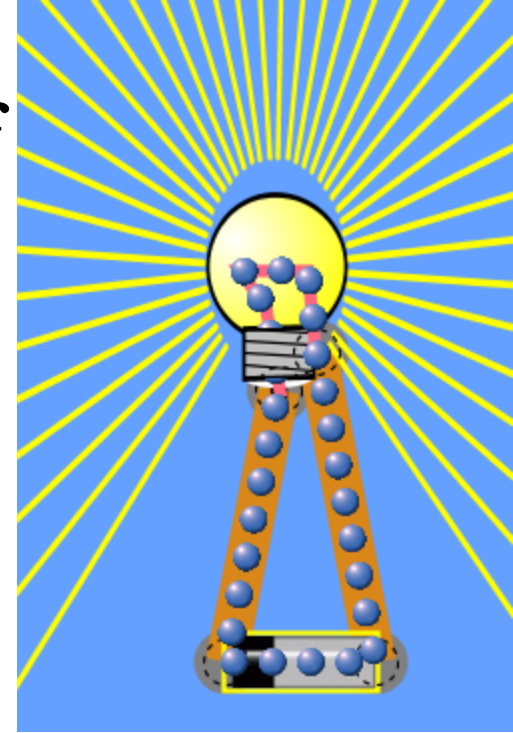

- A. The blue dots will get bigger to show more energy is being used**
- B. The blue dots will move faster to show more energy is being used**
- C. There is no change**

**4. If you build circuit A and then add a resistor as in circuit B, the light will**

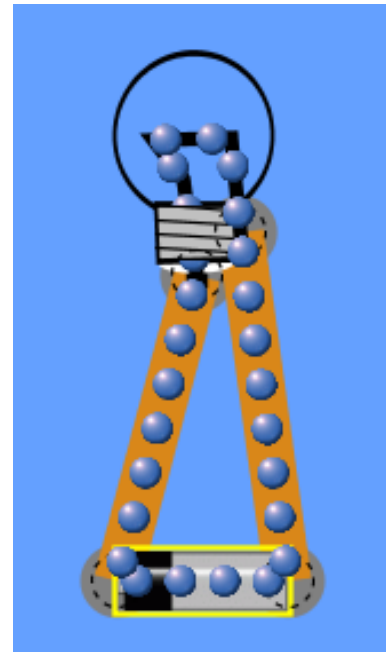

**A**

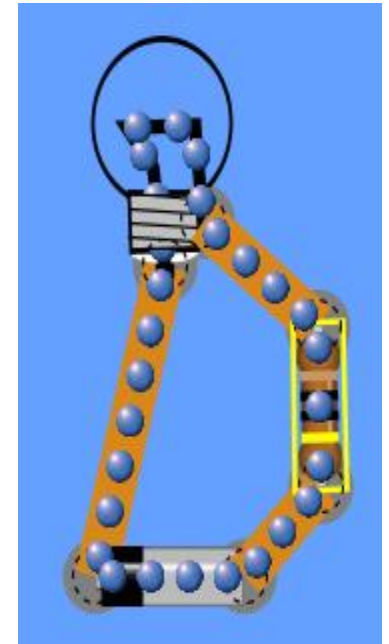

**B**

**A. Look brighter**

**B. Look less bright**

**C. There will no change in brightness**

# **Resistors in Series and Parallel Circuits**

- 1. Learning Goals: Students will be able to**
- 2. Discuss basic electricity relationships in series and parallel circuits**
- 3. Analyze the differences between real circuits and the simulated ones**
- 4. Build circuits from schematic drawings**
- 5. Use a multimeter to take readings in circuits.**
- 6. Provide reasoning to explain the measurements in circuits.**



1. Which shows the correct way to use an ammeter?

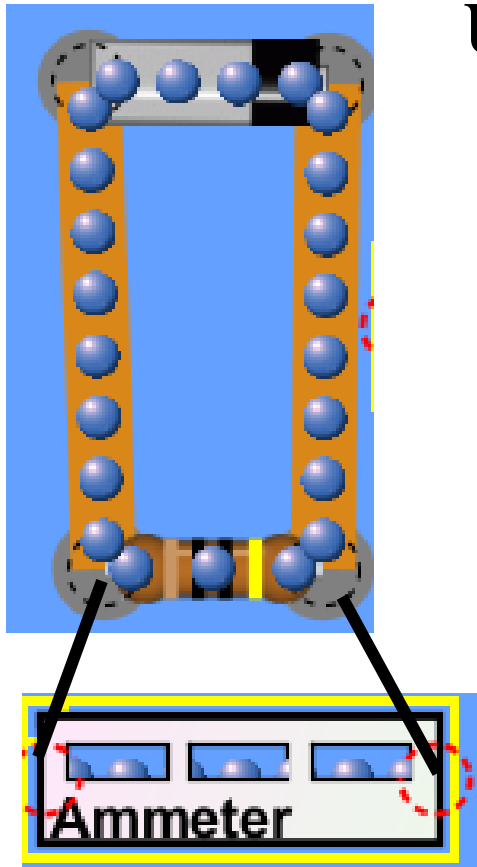

**A**

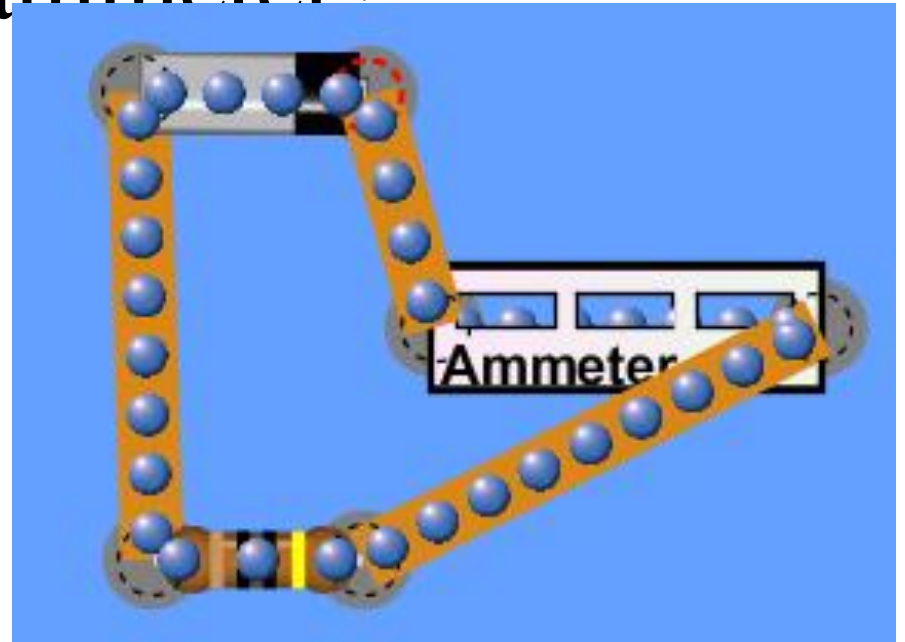

**B**

**2. Which resistor will have the greatest current?**

**A.  $50\ \Omega$**

**B.  $10\ \Omega$**

**C. They have the same current**

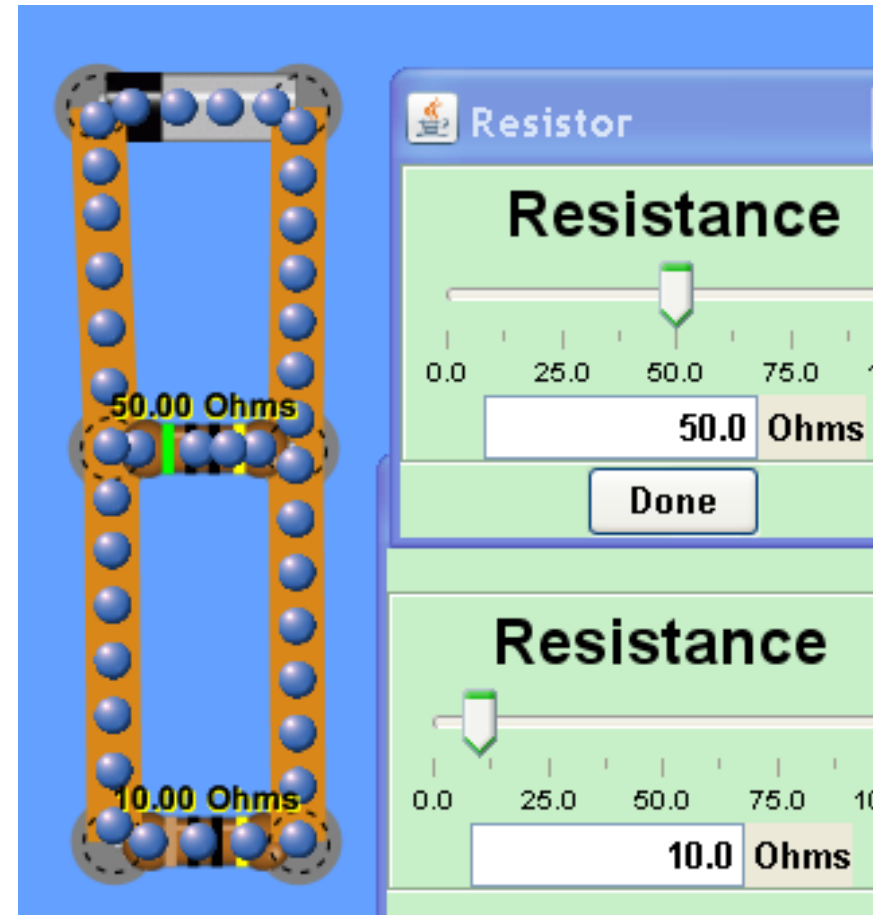

**3. Which resistor will have the greatest current?**

- A. The top resistor**
- B. The lower resistor**
- C. They have the same current**

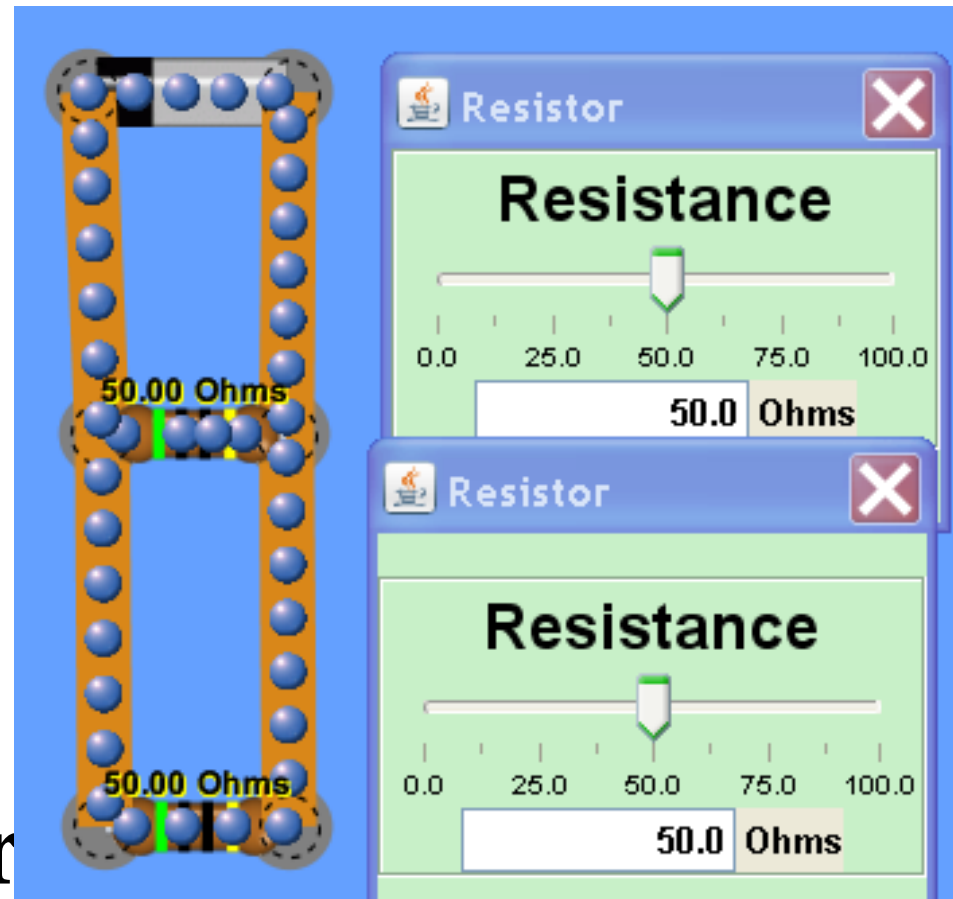

**4. Which resistor will have the greatest voltage?**

- A. The top resistor**
- B. The lower resistor**
- C. They have the same voltage**

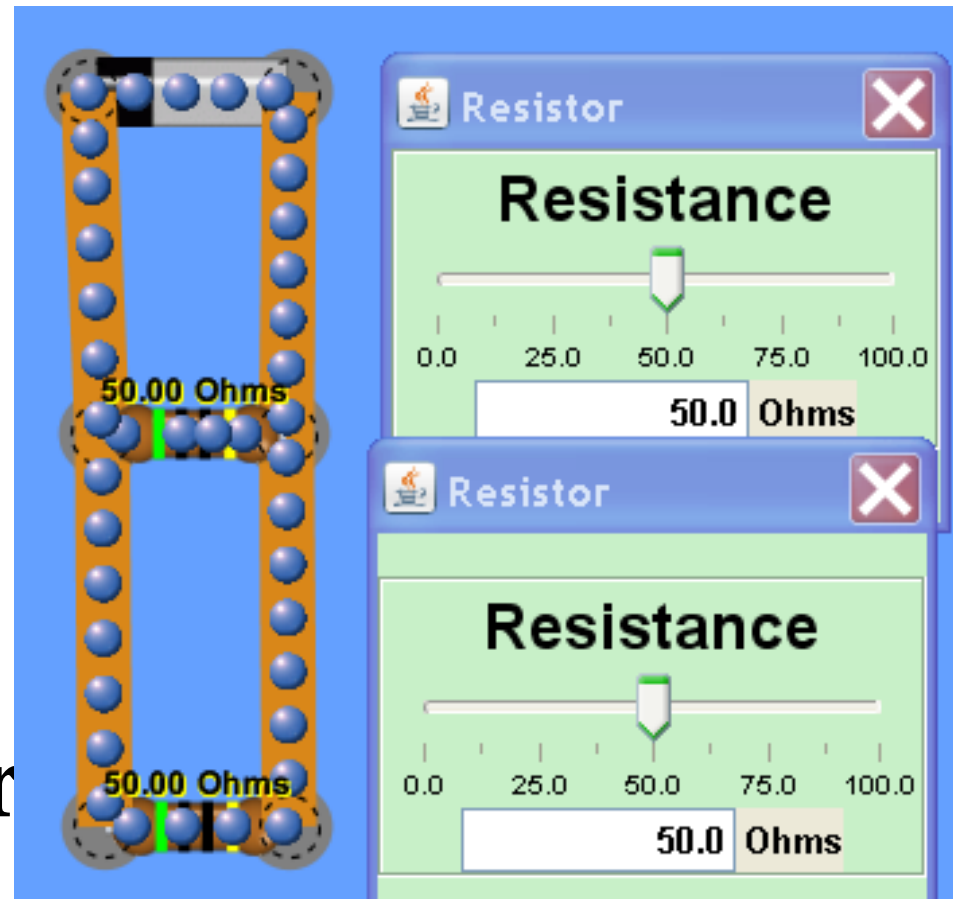

**5. Which resistor will have the greatest voltage?**

**A.  $50\ \Omega$**

**B.  $10\ \Omega$**

**C. They have the same voltage**

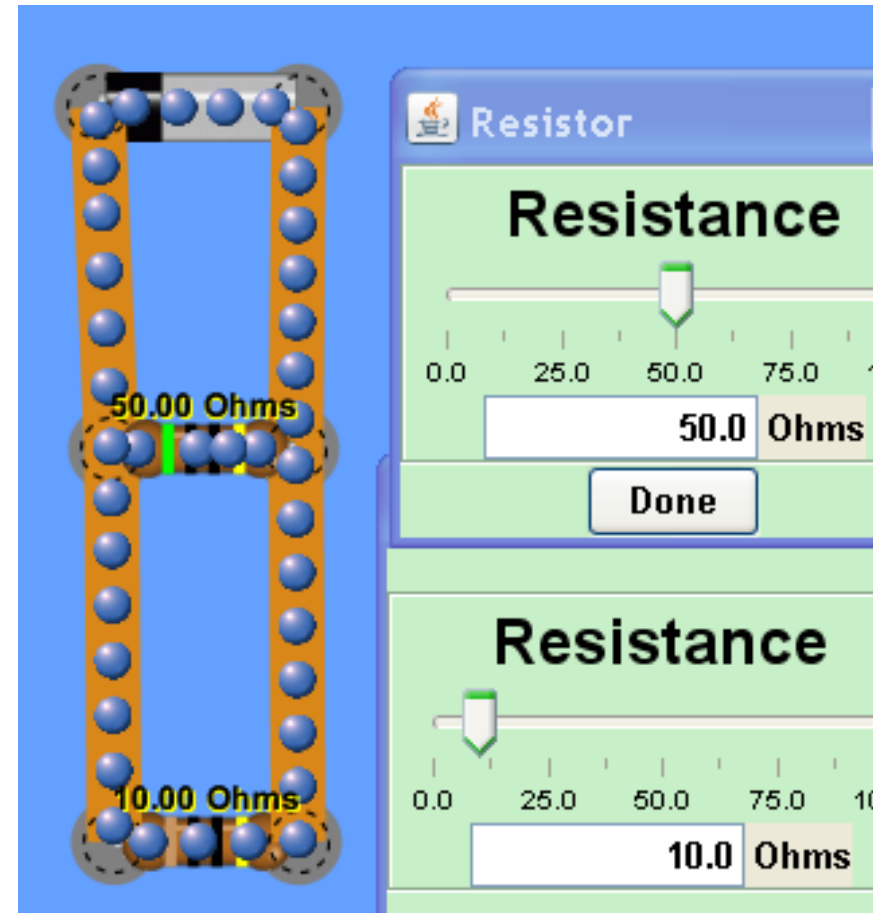

**6. Which resistor will have the greatest voltage?**

**A.  $50\ \Omega$**

**B.  $10\ \Omega$**

**C. They have the same voltage**

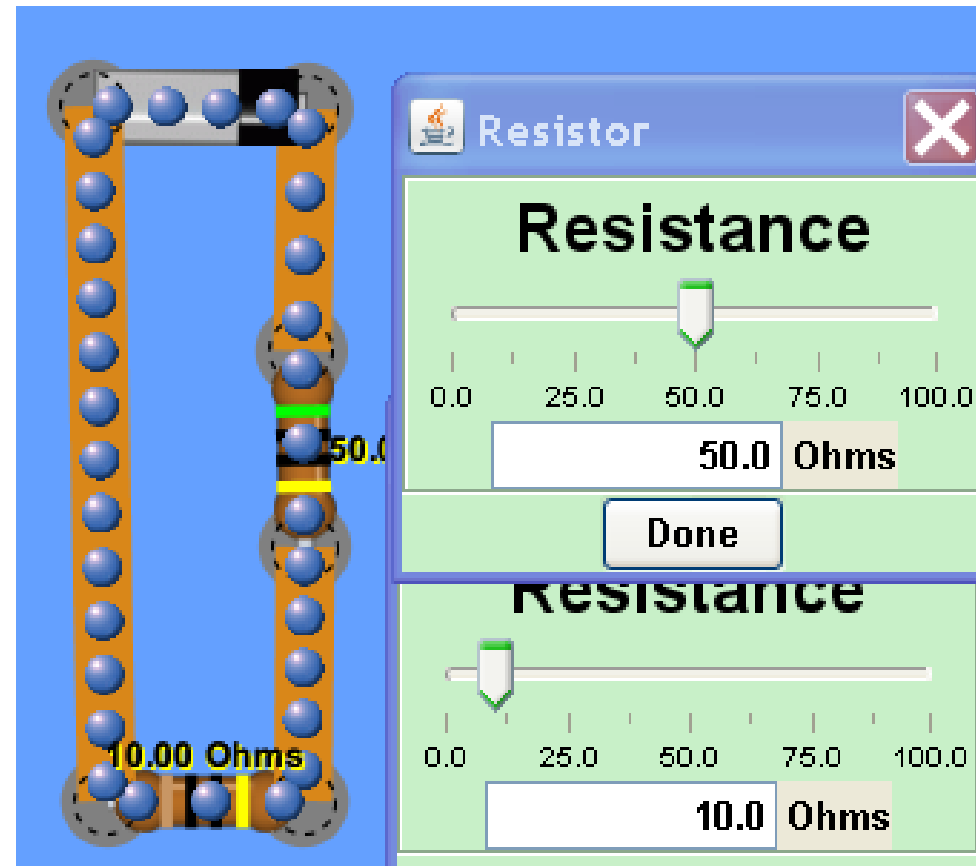

**7. Which resistor will have the greatest current?**

**A.  $50\ \Omega$**

**B.  $10\ \Omega$**

**C. They have the same current**

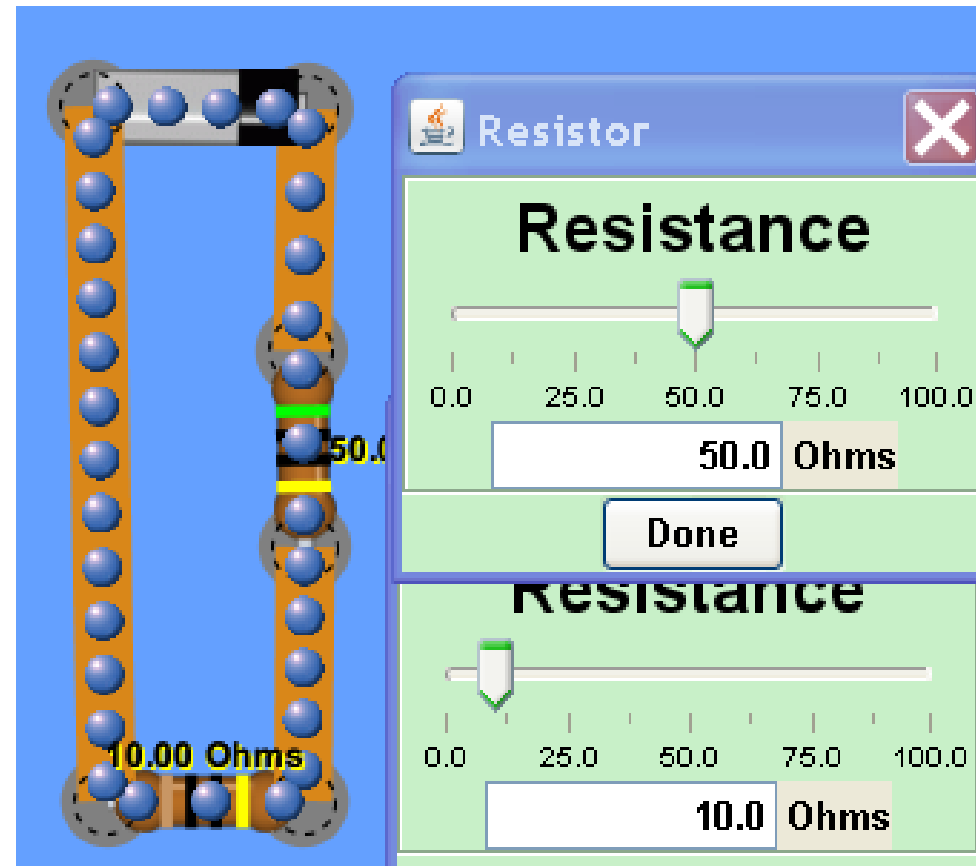

**8. Which resistor will have the greatest voltage?**

- A. The top resistor**
- B. The lower resistor**
- C. They have the same voltage**

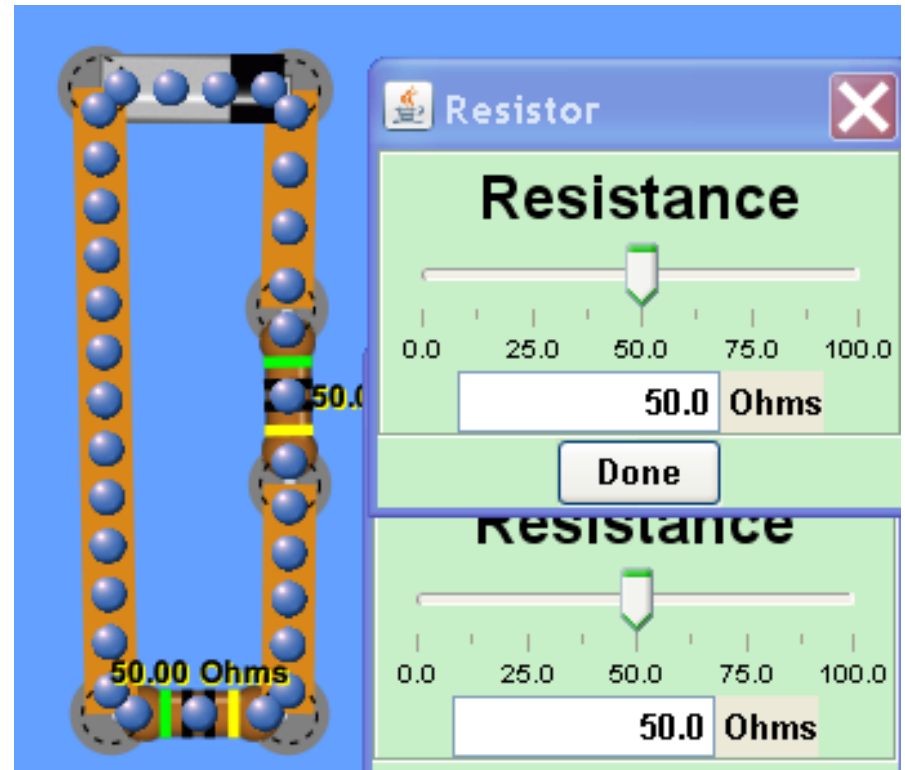



**9. Which resistor will have the greatest current?**

- A. The top resistor**
- B. The lower resistor**
- C. They have the same current**

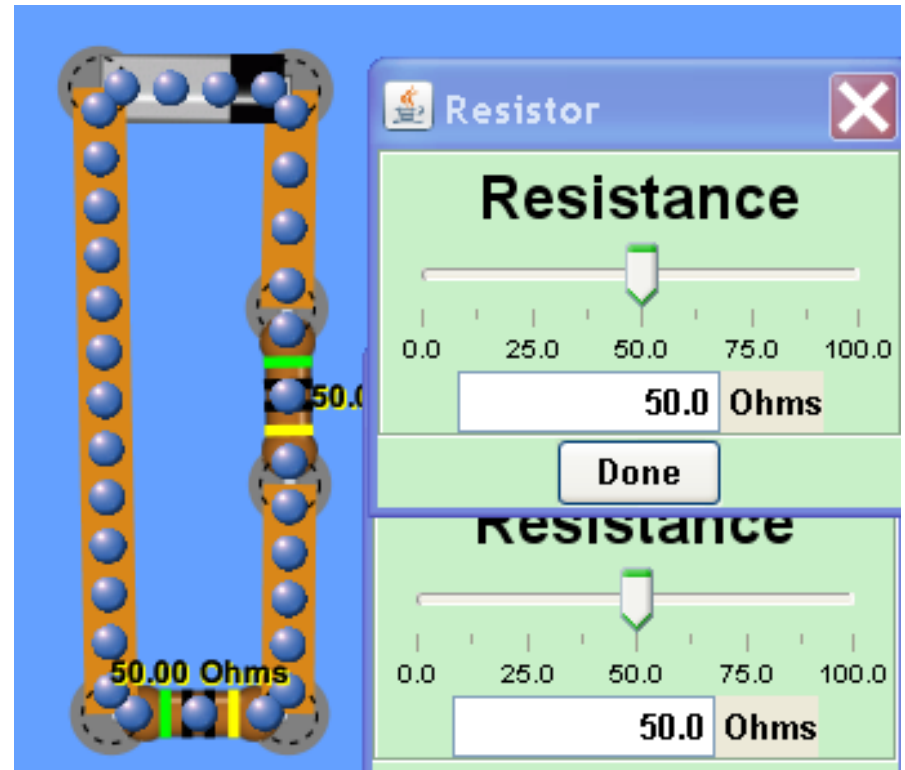

**10. What will happen if the voltage of the battery is increased to 25 volts?**

- A. The voltage across the resistor will increase**
- B. The voltage across the resistor will decrease**
- C. The voltage of the resistor does not change**

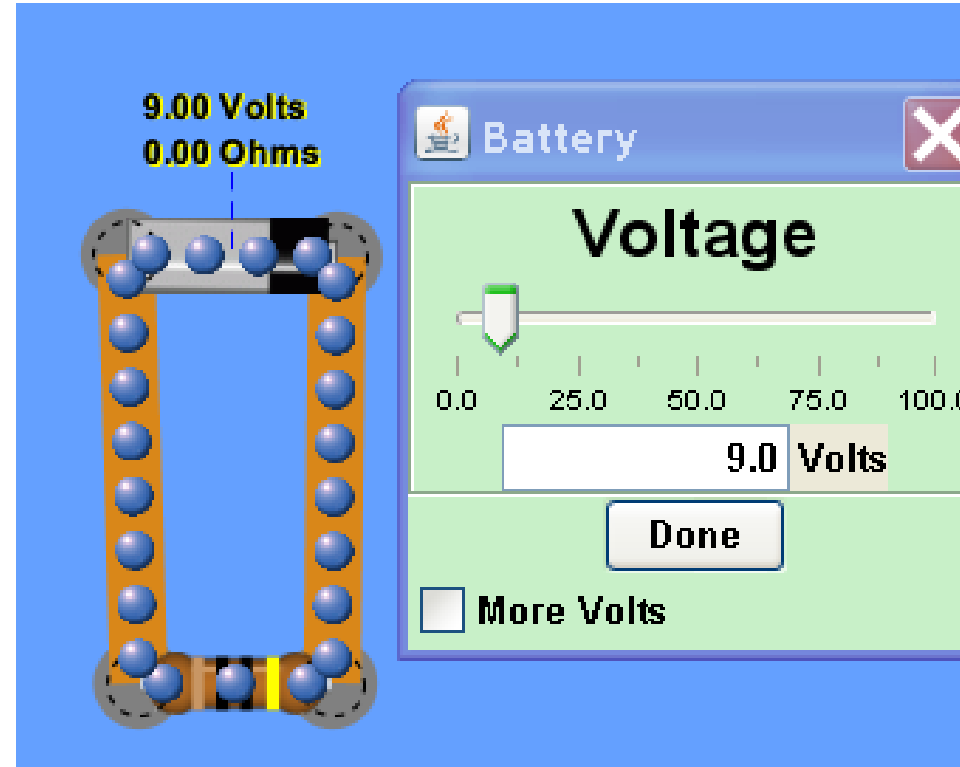

**11. What will happen if the voltage of the battery is increased to 25 volts?**

- A. The current through the resistor will increase**
- B. The current through the resistor will decrease**
- C. The current of the resistor does not change**

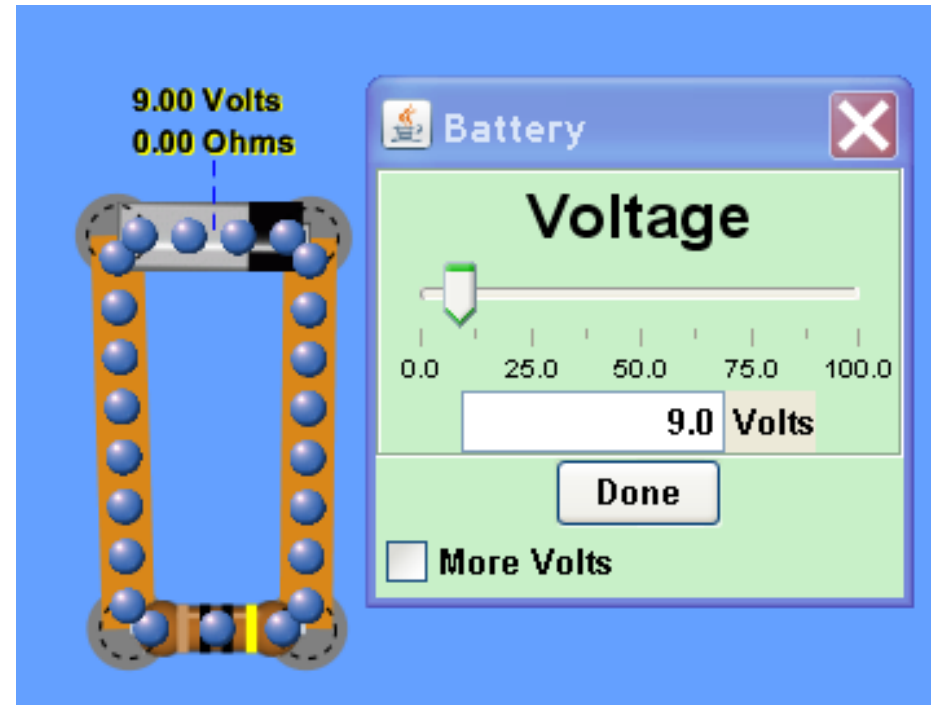

# Combo Circuit Lab

**Learning Goals: Students will be able to:**

- 1. Analyze the differences between real circuits and the ideal ones,**
- 2. Build circuits from schematic drawings,**
- 3. Use a multimeter to take readings in circuits.**
- 4. Provide reasoning to explain the measurements in circuits.**

12. What is the total resistance in this circuit?

- A.  $6.4 \Omega$
- B.  $21 \Omega$
- C.  $38 \Omega$
- D.  $75 \Omega$

10.0 Ohms    30.0 Ohms



13. What is the total resistance in this circuit?

- A.  $6.4 \Omega$
- B.  $21 \Omega$
- C.  $38 \Omega$
- D.  $75 \Omega$

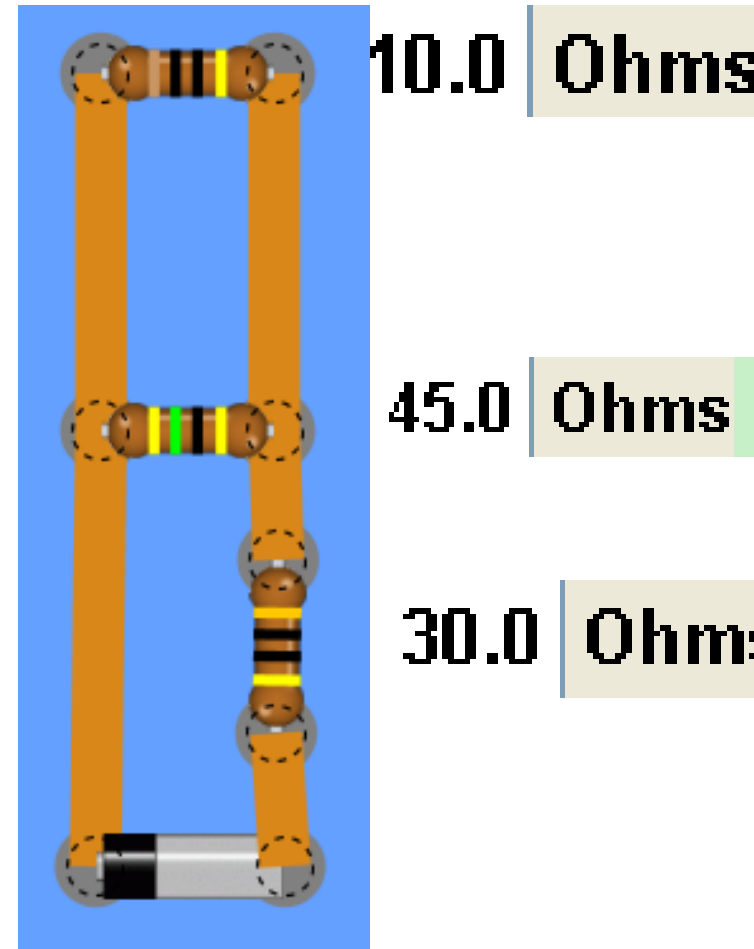

# *Faraday's Electromagnet Lab*

by Trish Loeblein May 10, 2010

**Learning Goals Activity 1: *Students will be able to***

- 1. Predict the direction of the magnet field for different locations around a bar magnet and electromagnet.**
- 2. Compare and contrast bar magnets and electromagnets**
- 3. Identify the characteristics of electromagnets that are variable and what effects each variable has on the magnetic field's strength and direction.**
- 4. Relate magnetic field strength to distance quantitatively and qualitatively**
- 5. Compare and contrast the fields of gravity and magnets qualitatively**

**Learning Goals Activity 2: Students will be able to:**

- Identify equipment and conditions that produce induction**
- Compare and contrast how both a light bulb and voltmeter can be used to show characteristics of the induced current**
- Predict how the current will change when the conditions are varied.**

**1. Which compass shows the correct direction of the magnet field at point A?**

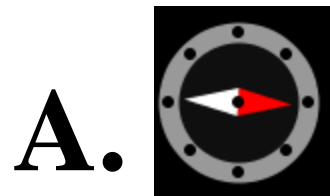

**A**

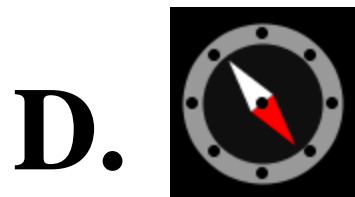
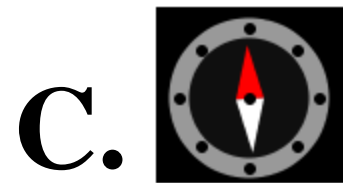
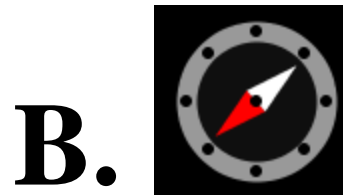



**2. Which compass shows the correct direction of the magnet field at point A?**

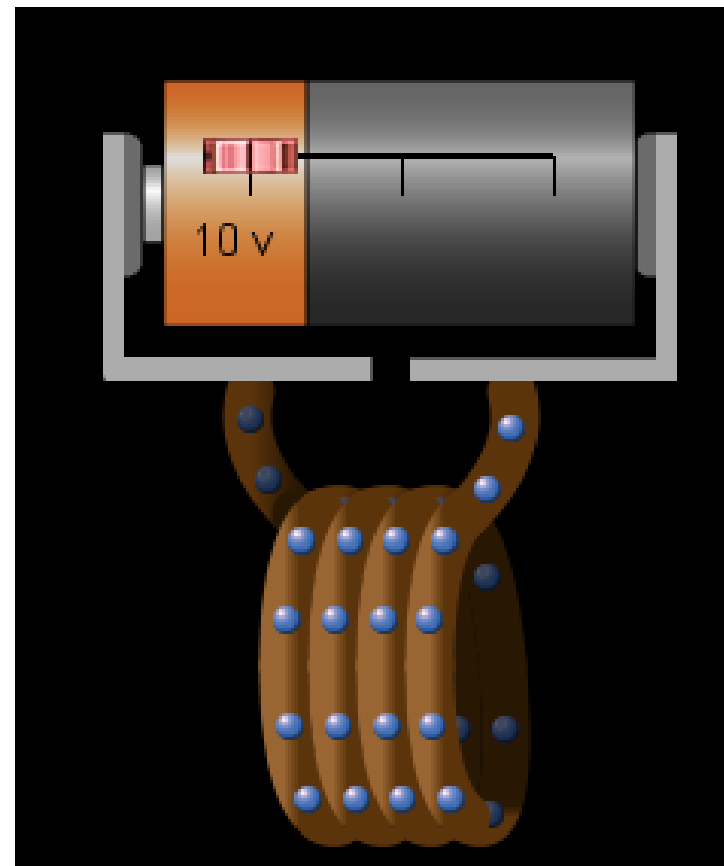
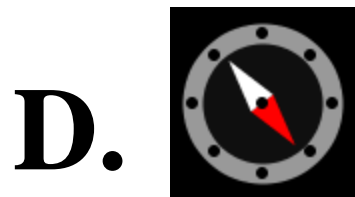
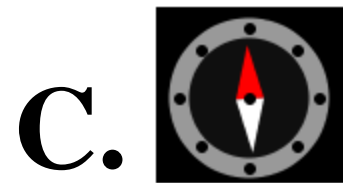
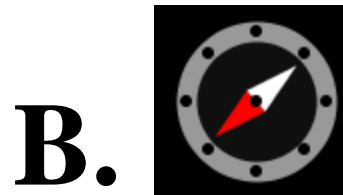

**A**

**3. Which compass shows the correct direction of the magnet field at point A?**

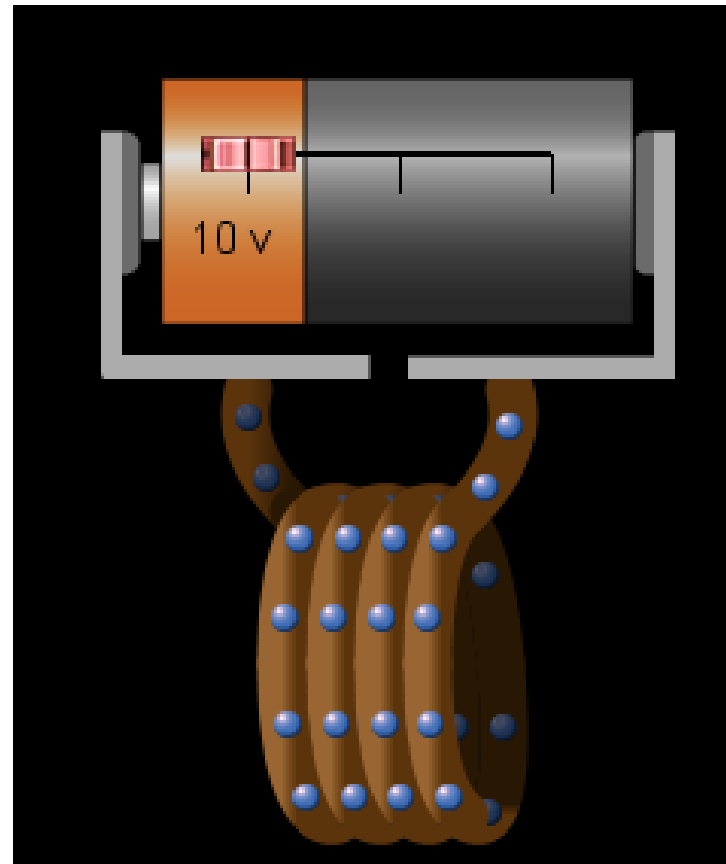
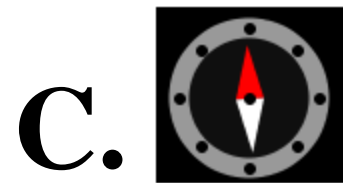
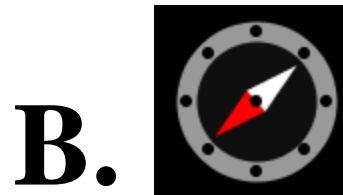

**A**

**4. What will happen if you switch the battery so that the positive end is on the right?**

- A. The electrons will go faster
- B. The electrons will go the slower
- C. The compass will switch directions
- D. The electrons will go the other direction
- E. Two of the above.

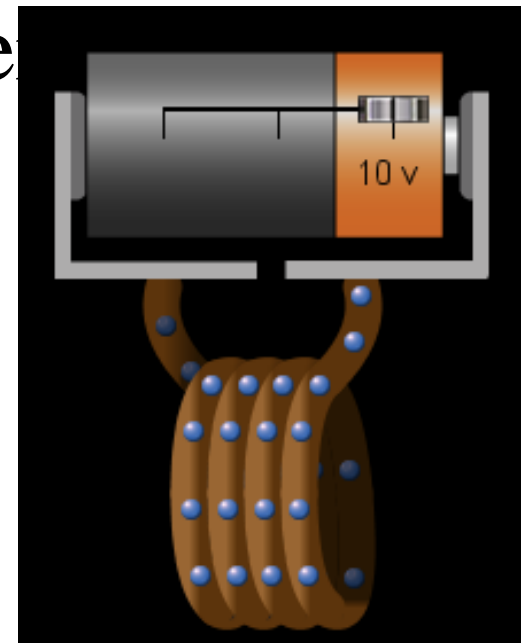
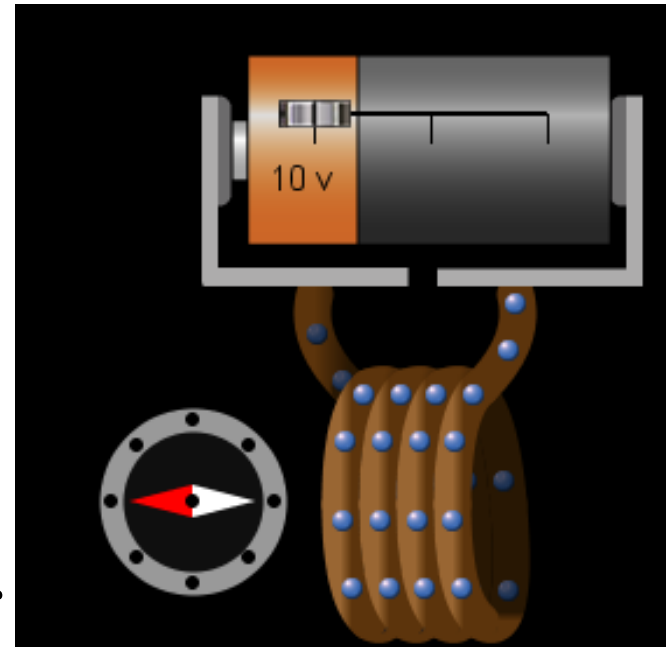

**5. What would you expect the light to do if you change the coils from 2 to 3 and you move the magnet the same speed?**

- A. Show the same brightness**
- B. Show less brightness**
- C. Show more brightness**

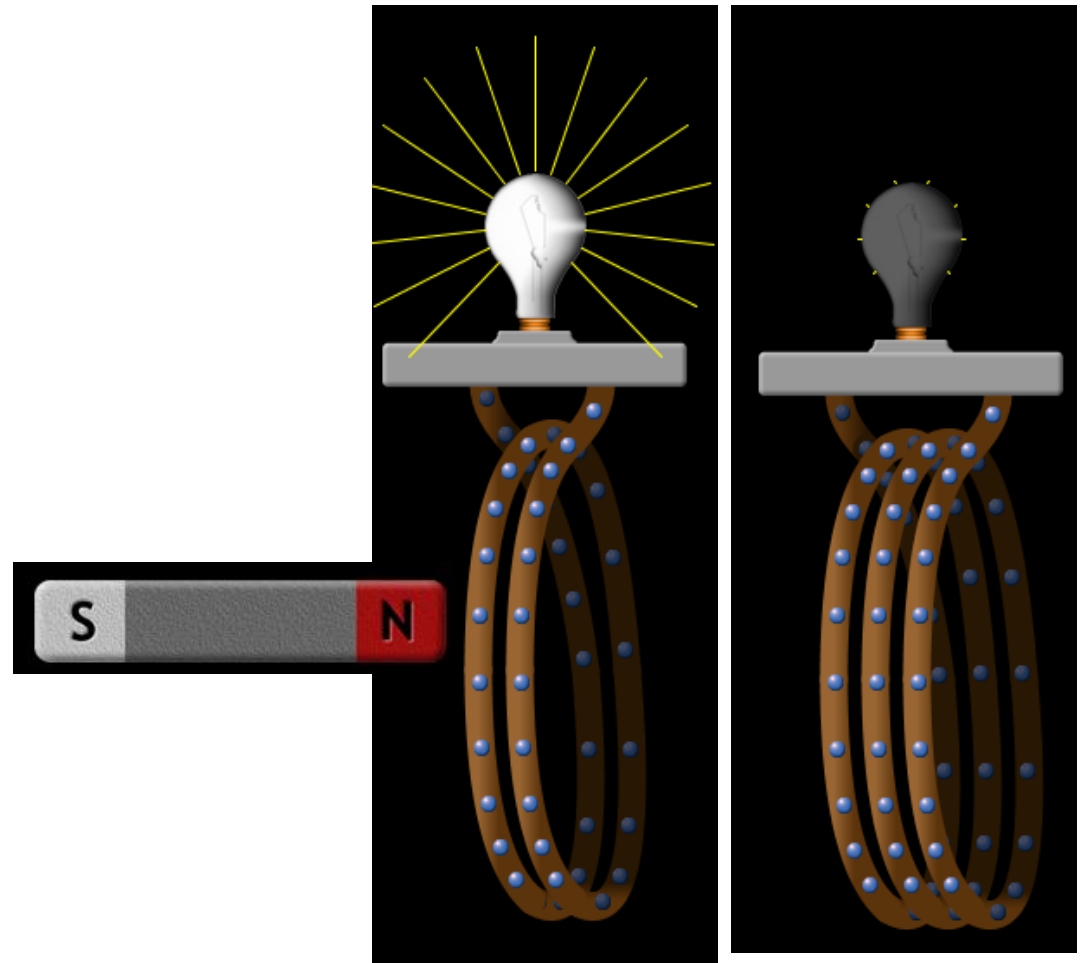

**6. Which would be a more strong magnet?**

**A. A**

**B. B**

**C. They would be the same**

**D. Not enough information to decide**

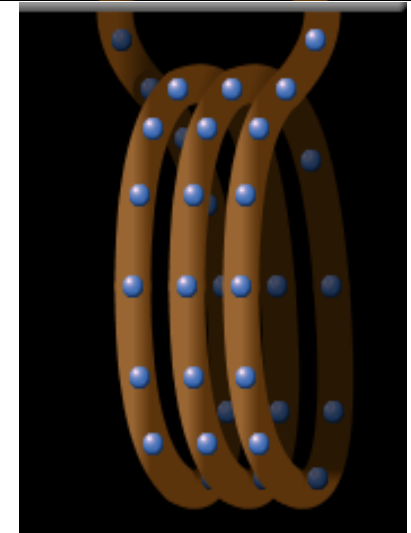
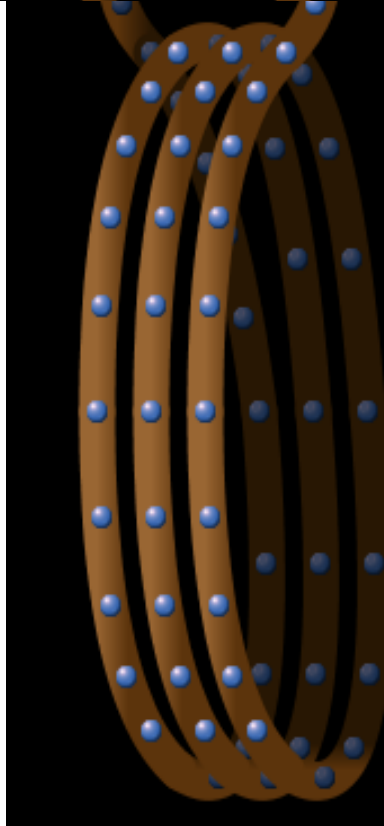
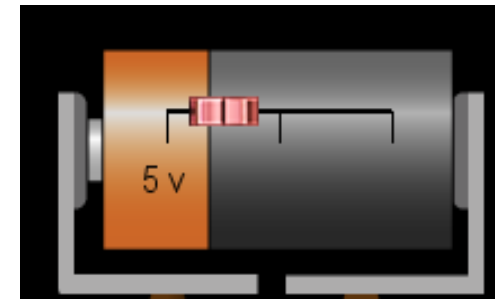
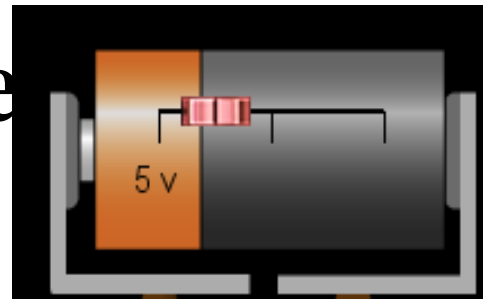

**A**

**B**

**7. Which would be a more strong magnet?**

**A. A**

**B. B**

**C. They would be the same**

**D. Not enough information to decide**

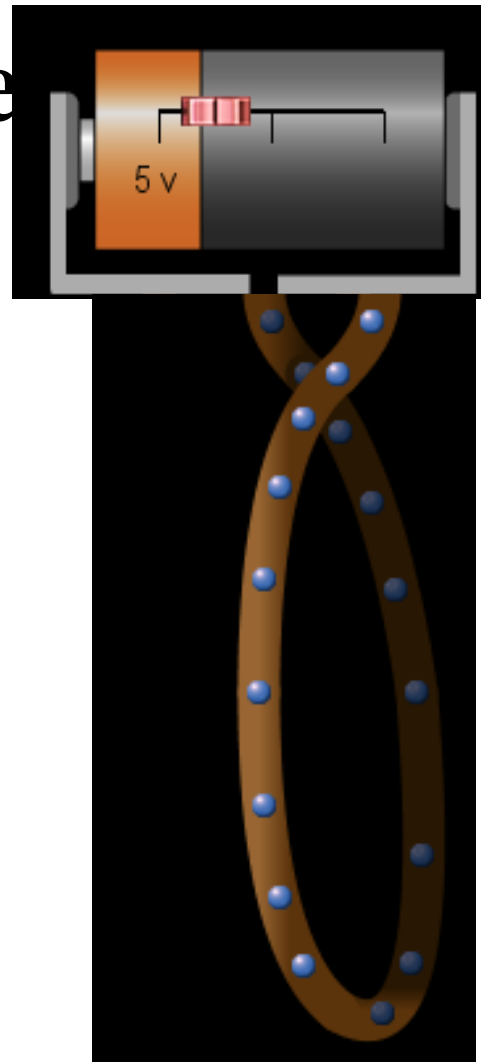

**A**

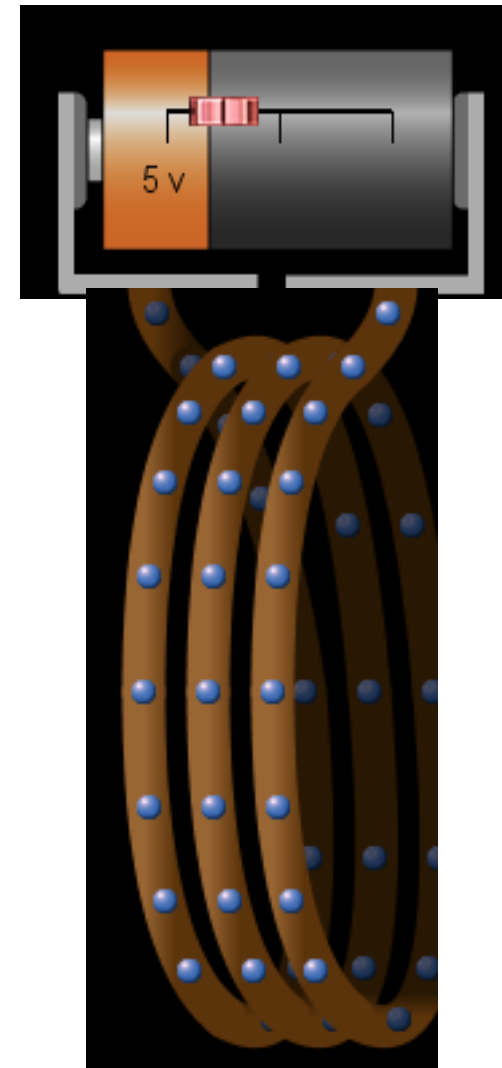

**B**

# Gravity and Orbits

Trish Loeblein 2/20/11 Only one question at present and it deals with vector representation of forces on moon.

**Learning Goals-** Students will be able to

- Draw motion of planets, moons and satellites.
- Draw diagrams to show how gravity is the force that controls the motion of our solar system.
- Identify the variables that affect the strength of the gravity
- Predict how motion would change if gravity was stronger or weaker.

Which vector representation would show the moon between the earth and the sun? (black arrow Total Gravity Force moon)

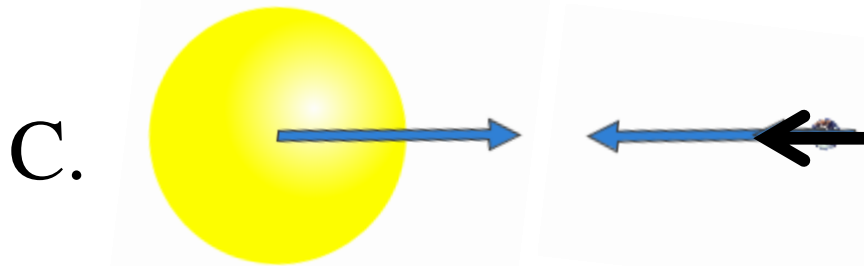
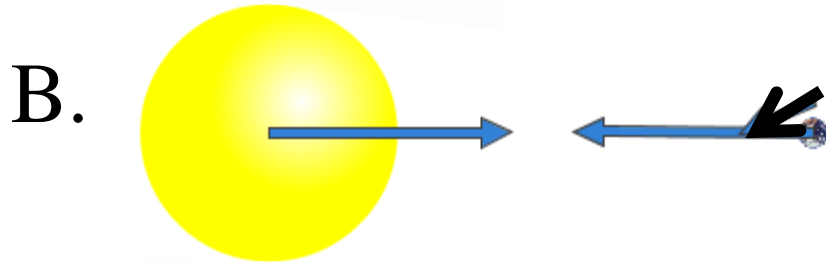
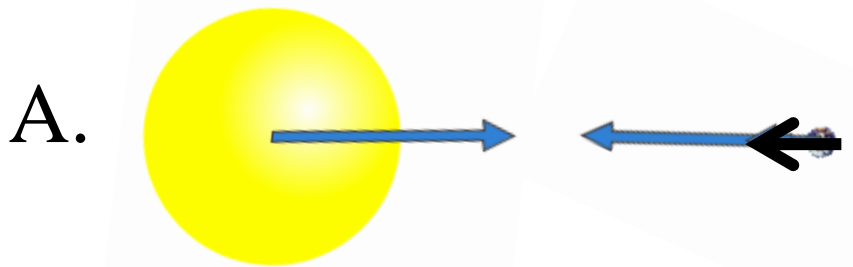



Use the simulation to show the path of the moon and the resulting vectors.

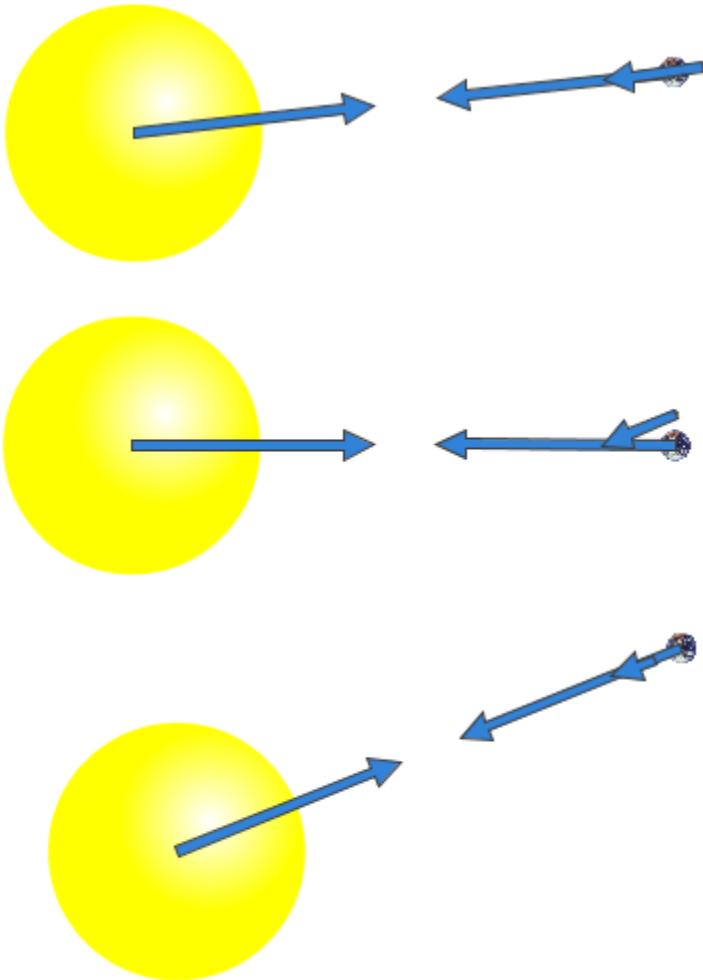

Remember that the placement of vectors in space is arbitrary. The point  $(0,0)$  can be anywhere.

# *Concept Questions for Balloons and Static Electricity and John Travoltage*

Learning Goals: Students will be able to describe and draw models for common static electricity concepts. (transfer of charge, induction, attraction, repulsion, and grounding)

[Activity link](#)

**1. When the balloon is rubbed on the sweater, what might happen?**

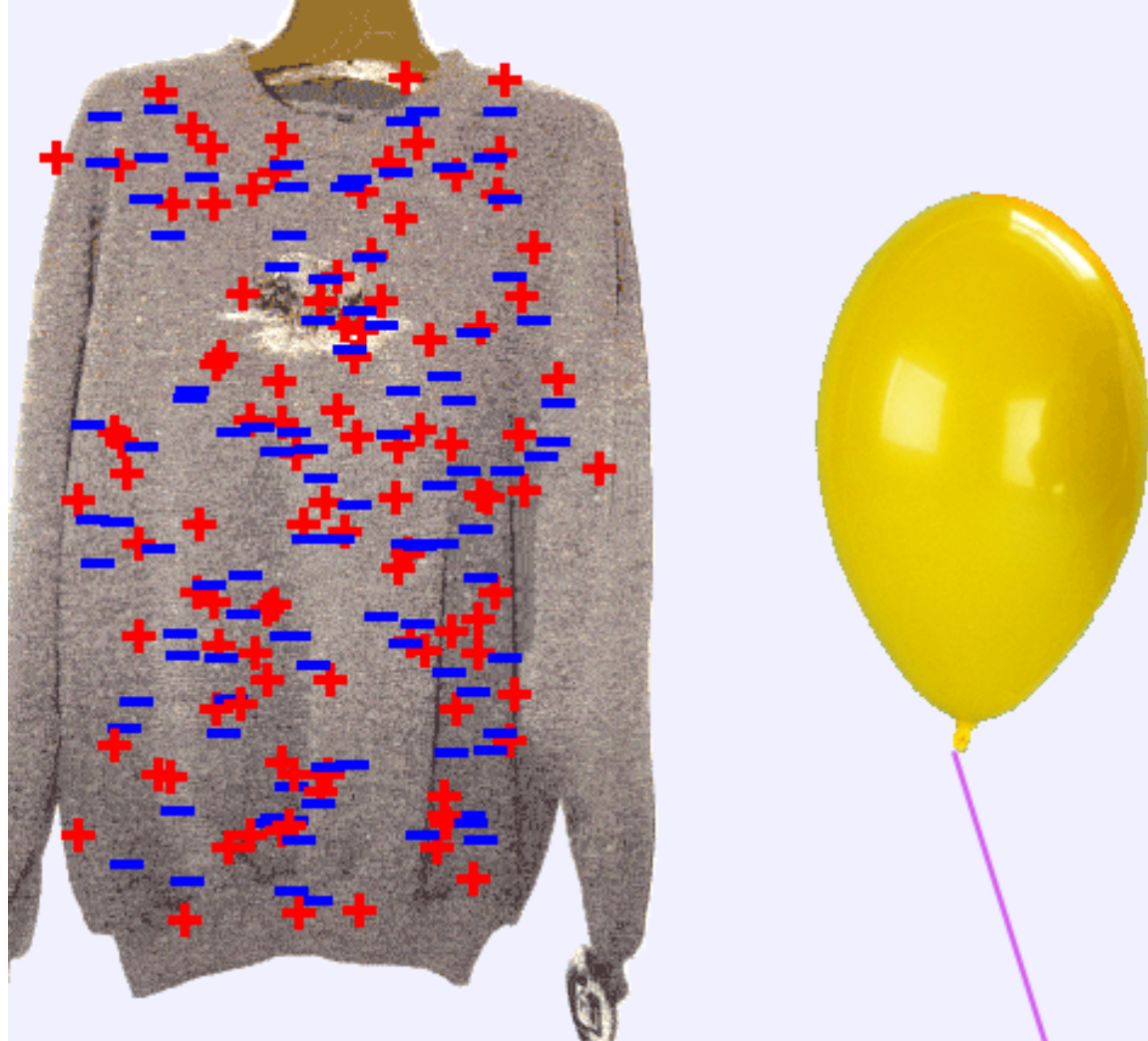

1. When the balloon is rubbed on the sweater, what might happen?

**A. Some positive charges in the sweater will move onto the balloon**

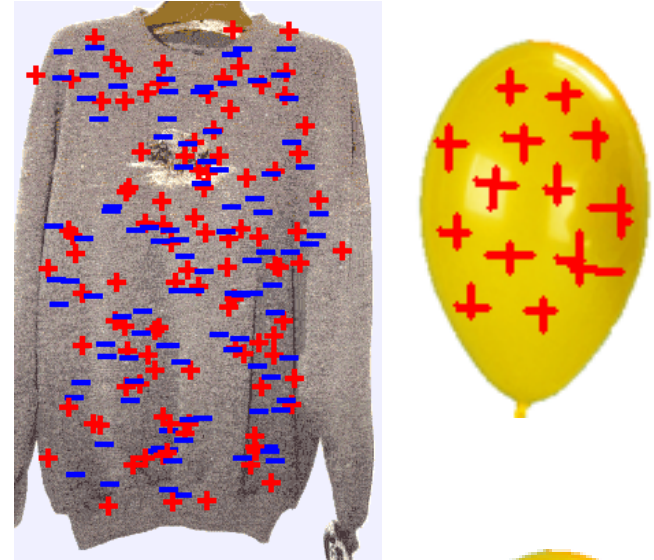

**B. Some negative charges in the sweater will move onto the balloon**

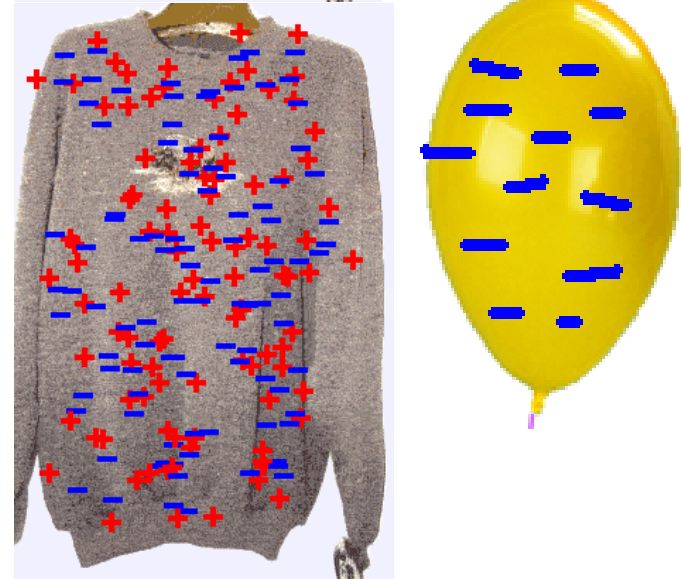

**2. What do you think will happen when the balloon is moved closer to the wall?**

**Negatively charged balloon**

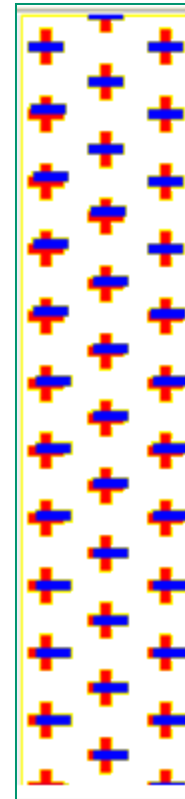
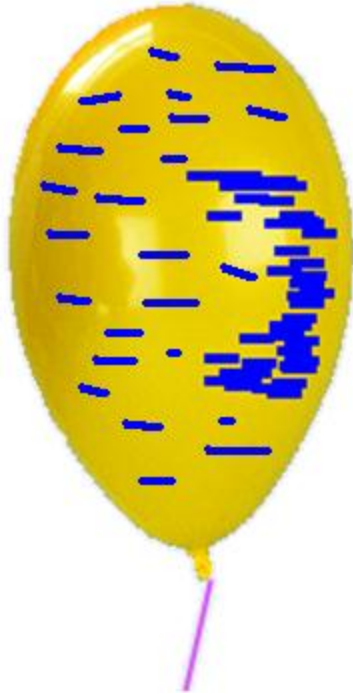

**Neutral wall**

2. What do you think will happen when the balloon is moved closer to the wall?

**A. Some positive charges in the wall will move towards the balloon**

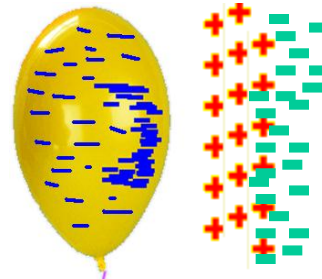

**B. Some negative charges in the wall will move towards the balloon**

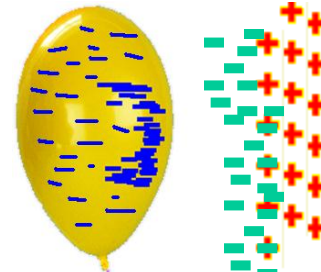

**C. Some positive charges in the wall will go onto the balloon**

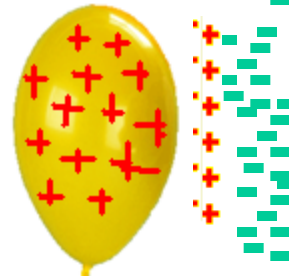

**D. Some negative charges on the balloon will go to the wall**

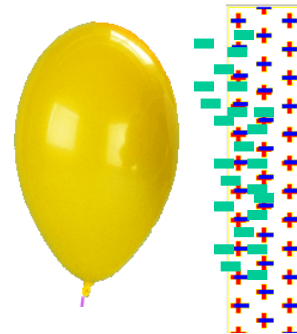

### 3. What do you think the balloons will do?

**Negatively  
charged  
balloon**

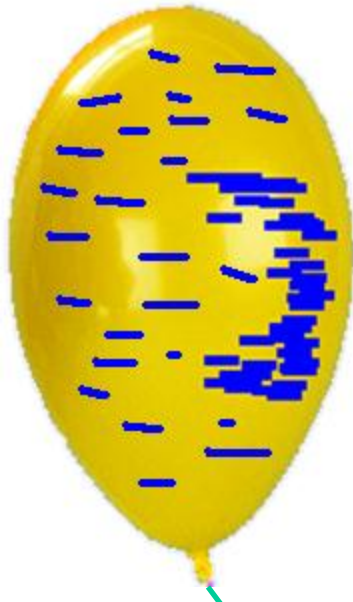

**Negatively  
charged  
balloon**

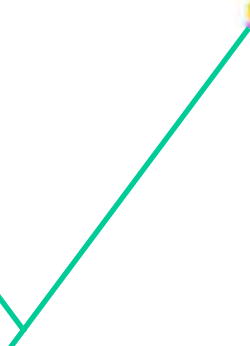
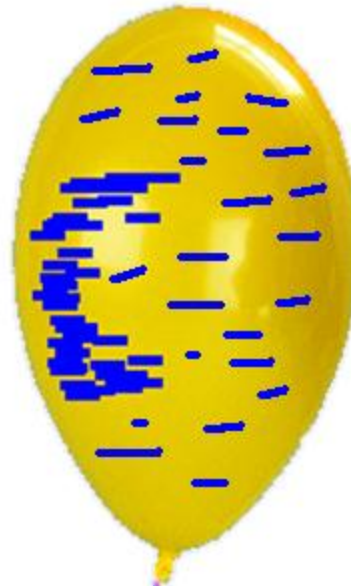

**3. What do you think the balloons will do?**

**A. The balloons will move towards each other**

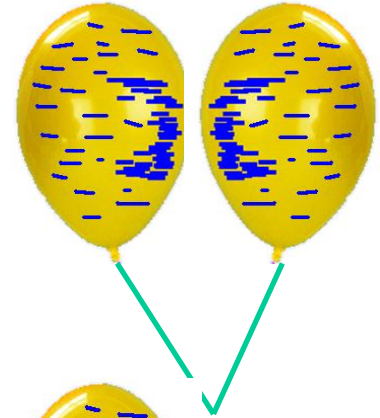

**B. The balloons will move away from each other**

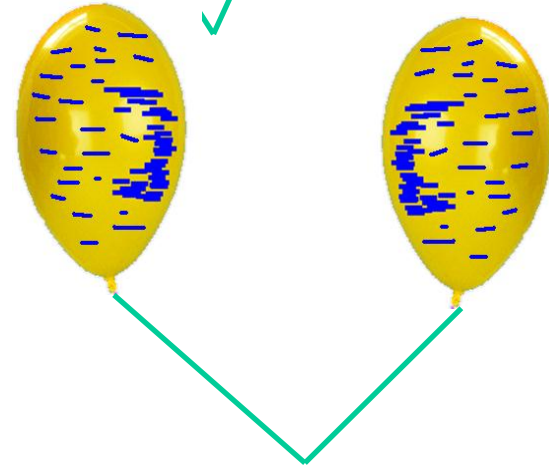

**C. The balloons will not move.**

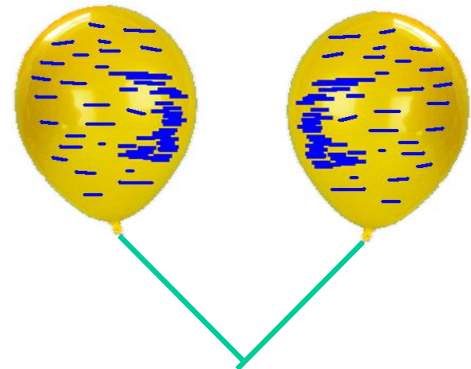



**4. What might happen to the charge on the man when he touches the door knob?**



**4. What might happen to the charge on the man when he touches the door knob?**

**A. Most electrons will go into the knob and down to the earth.**



**B. Some electrons will go from the earth through the knob and into the man.**



Wave Interference [Activity](#) is a demo that uses three simulations: *Waves on a String*, *Wave Interference*, and *Sound*.

Trish Loeblein [phet.colorado.edu](http://phet.colorado.edu)

## **Learning Goals:** Students will be able to

- Predict the pattern of a reflected wave
- Relate two dimensional representations of waves to three dimensional waves
- Explain wave patterns from interfering waves (*Apply the superposition principle to water, sound and light*)
- Recognize the Doppler effect and predict the change in frequency that occurs.

1. What will this wave look like after it reflects?

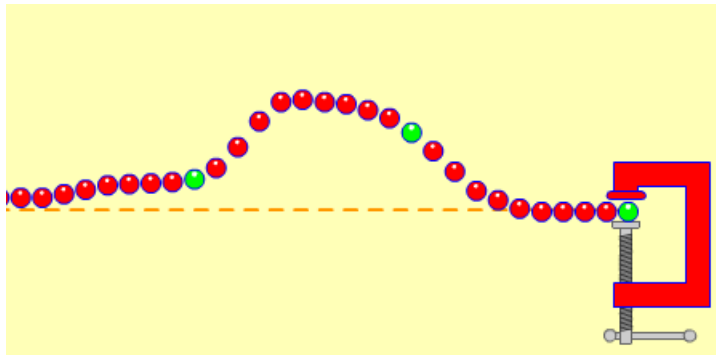

**Fixed end**

**A.**

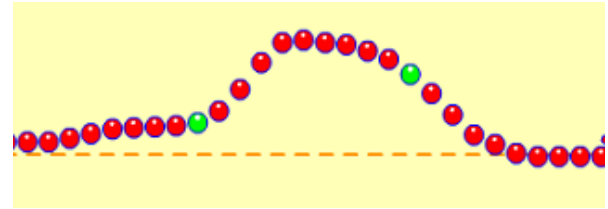

**B.**

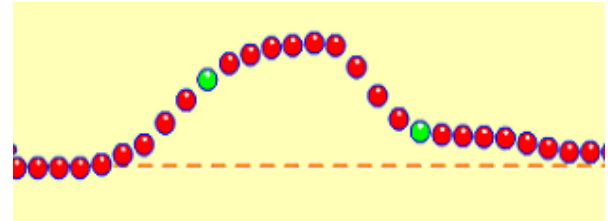

**C.**

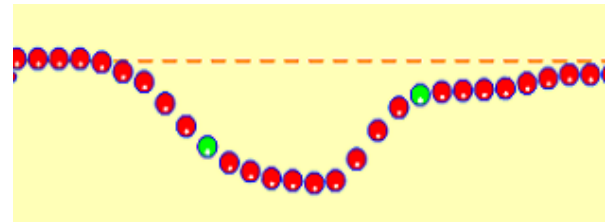

**D.**

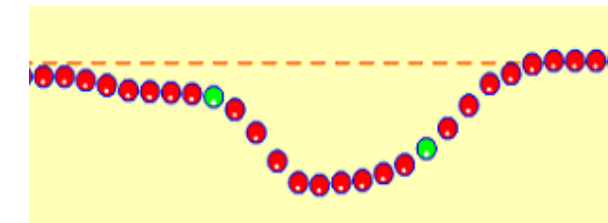

## 2. What will this wave look like after it reflects?

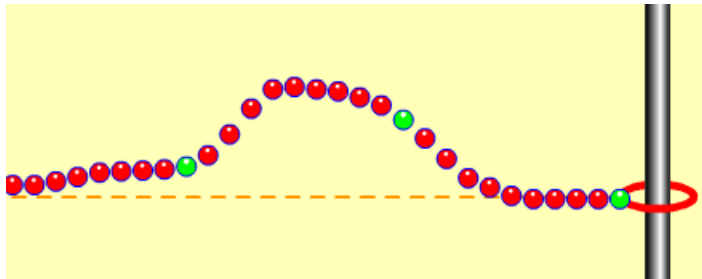

**Loose end**

**A.**

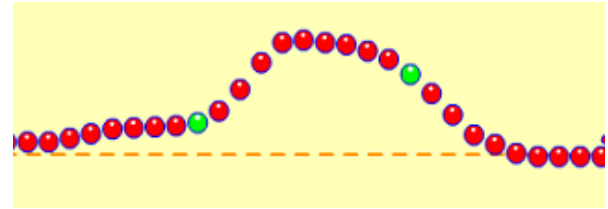

**B.**

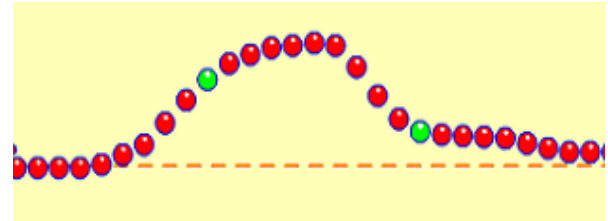

**C.**

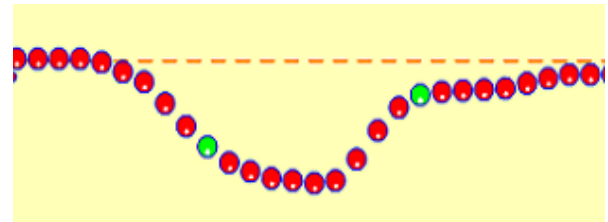

**D.**

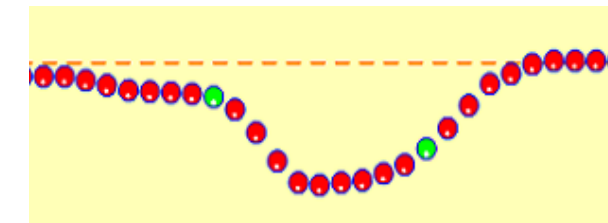

Draw what you think this wave will look like after reflecting off the barrier.

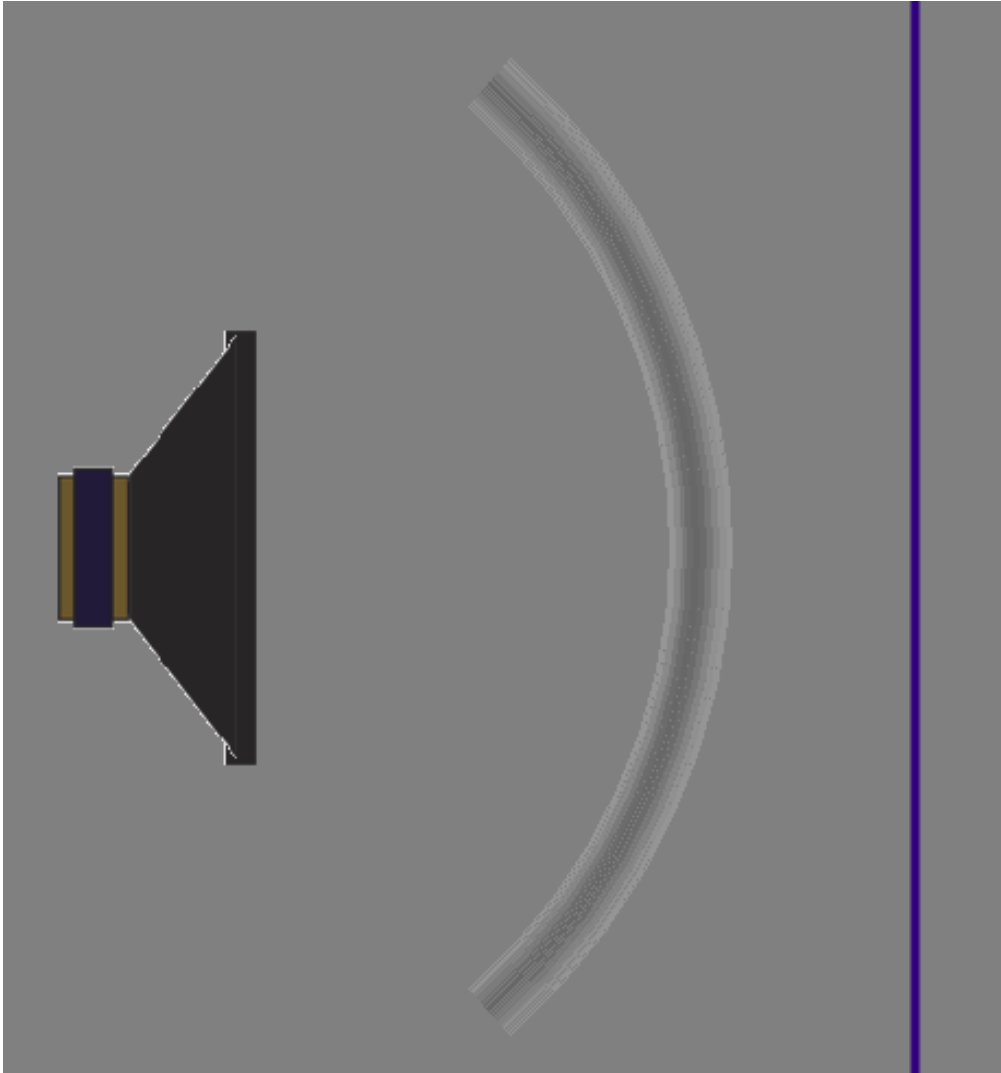

3. Which one is the reflection pattern?

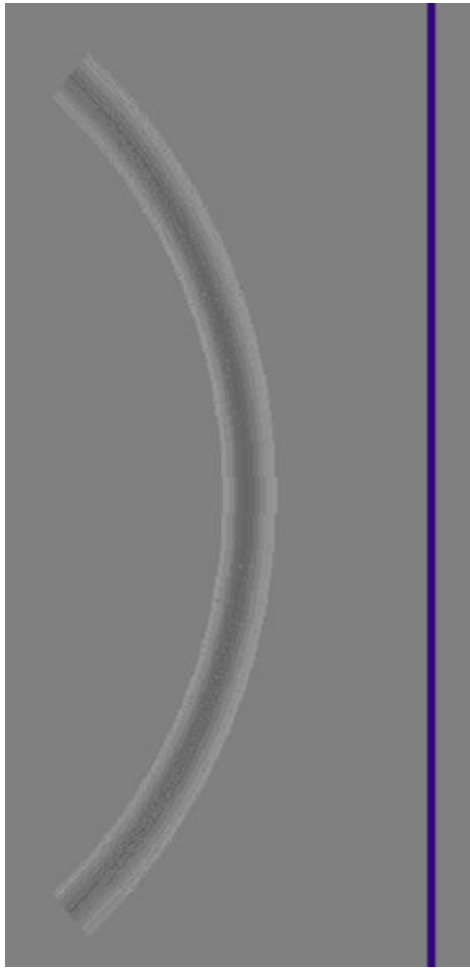

Wave pulse from speaker

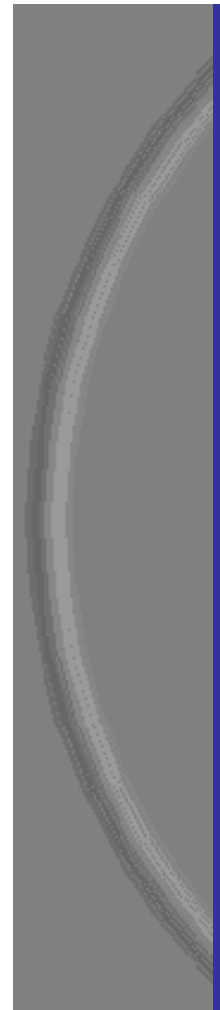

A



B

“Sound waves are three dimensional.”

Talk to your partner:

- What evidence you have that supports this.
- How the wave could be represented
- How would reflection change?



Sketch what you think the pattern  
will look like

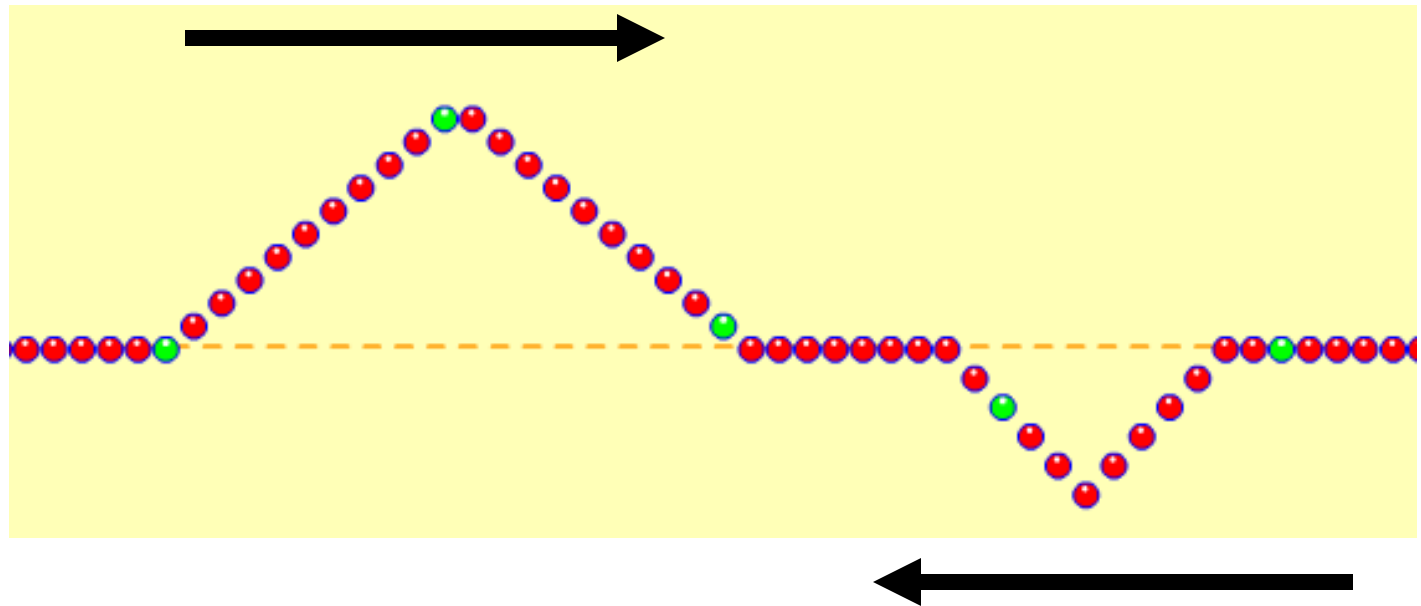

# Measurements

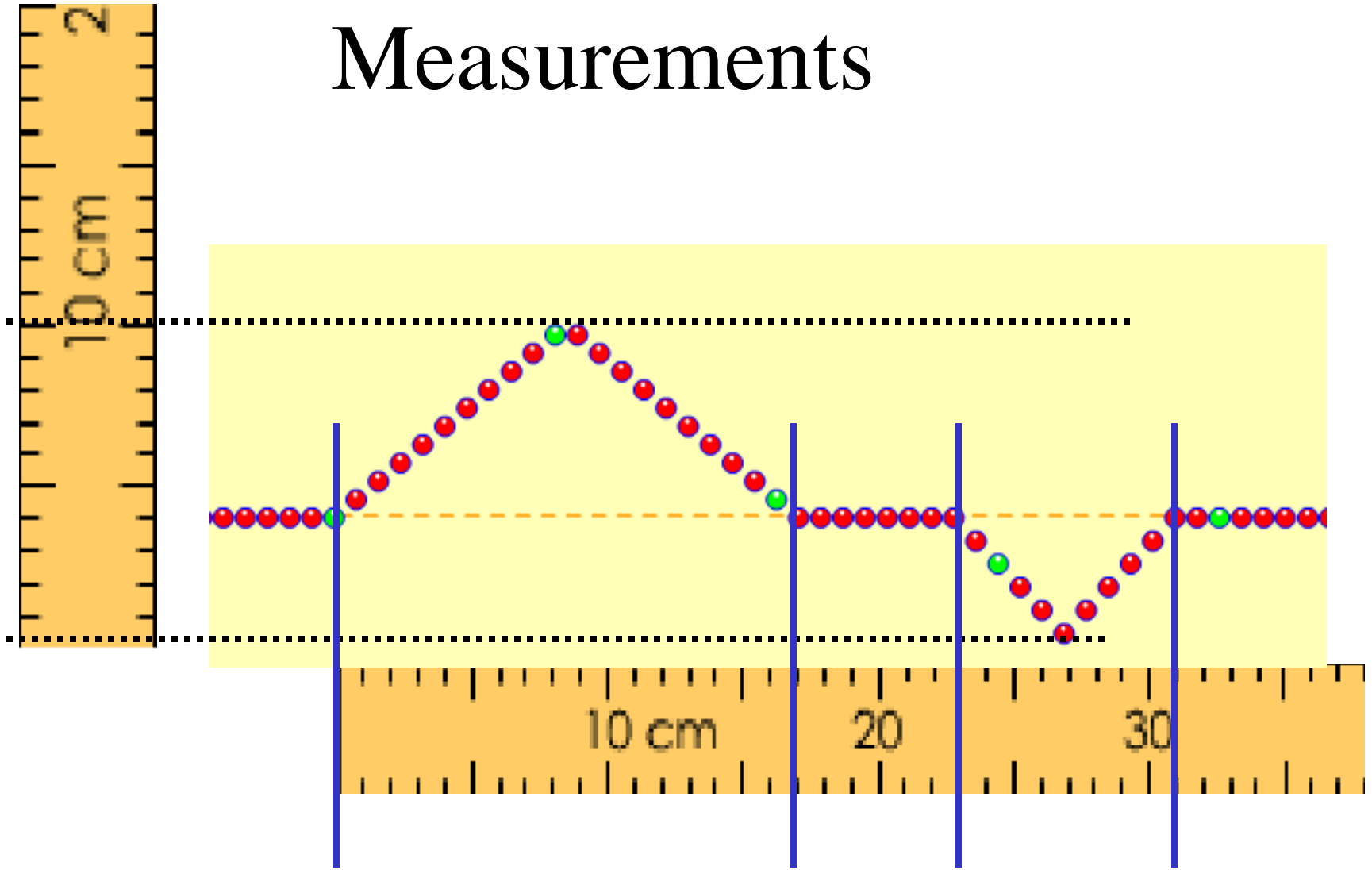

# Paused clips

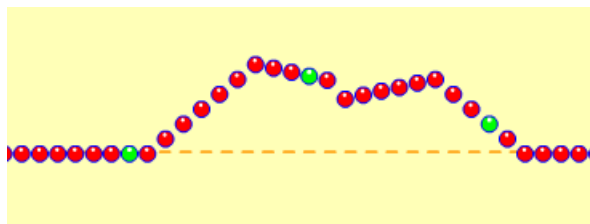
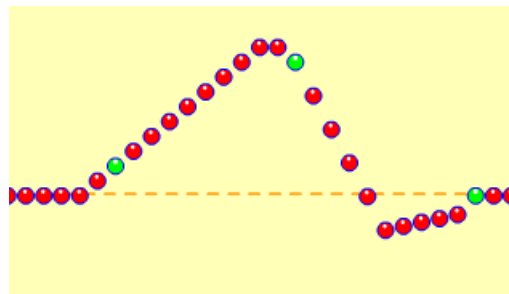
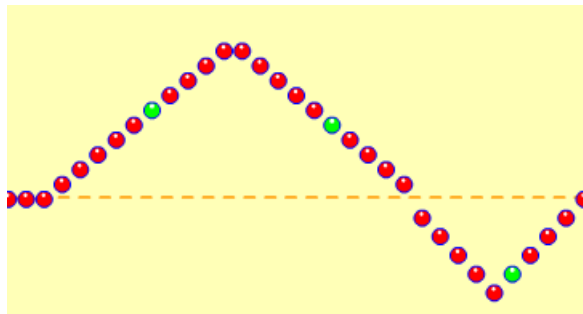

# Resonance

## Clicker questions

by Trish Loeblein and Mike Dubson

**Learning Goals:** Students will be able to:

1. Describe what resonance means for a simple system of a mass on a spring.
2. Identify, through experimentation, cause and effect relationships that affect natural resonance of these systems.
3. Give examples of real-world systems to which the understanding of resonance should be applied and explain why. (not addressed in CQ's)

**1. Which system will have the lower resonant frequency?**

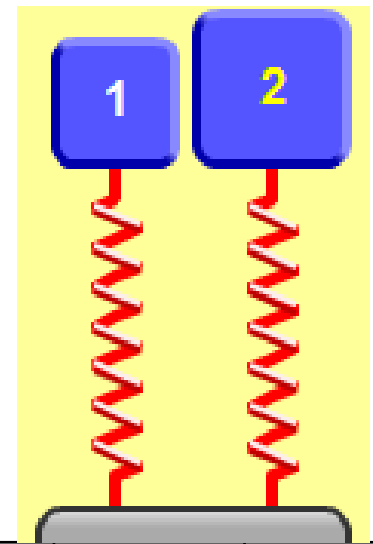

<b>Mass (kg)</b>	<b>2.5</b>	<b>5.0</b>
<b>Spring constant (N/m)</b>	<b>100</b>	<b>100</b>

**A) 1   B) 2   C) Same frequency**

**2. Which system will have the lower resonany frequency?**

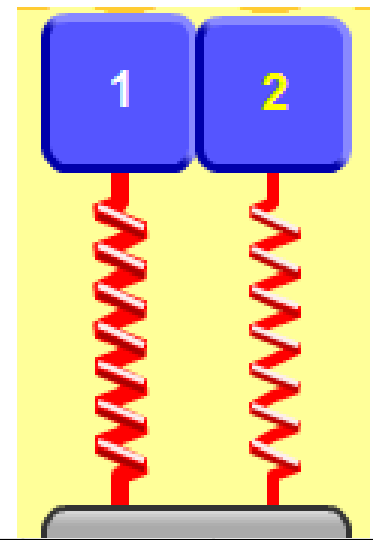

<b>Mass (kg)</b>	<b>5.0</b>	<b>5.0</b>
<b>Spring constant (N/m)</b>	<b>200</b>	<b>100</b>

**A) 1   B) 2   C) Same frequency.**

**3. Which system will have the lower resonance frequency?**

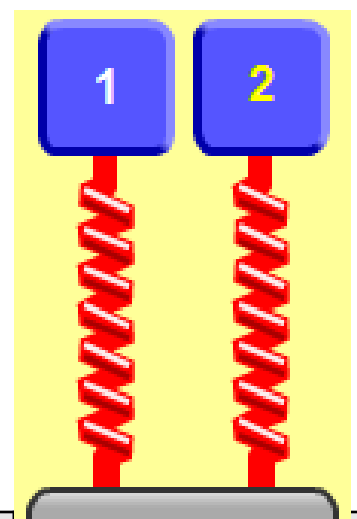

<b>Mass (kg)</b>	<b>3.0</b>	<b>3.0</b>
<b>Spring constant (N/m)</b>	<b>400</b>	<b>400</b>
<b>Driver Amplitude (cm)</b>	<b>0.5</b>	<b>1.5</b>

**A) 1   B) 2   C) Same frequency.**

**4. Which best describes how the motion of the masses vary?**

- A. Less driver amplitude results in greater max height & faster oscillation**
- B. More driver amplitude results in greater max height & faster oscillation**
- C. Less driver amplitude results in greater max height**
- D. More driver amplitude results in greater max height**

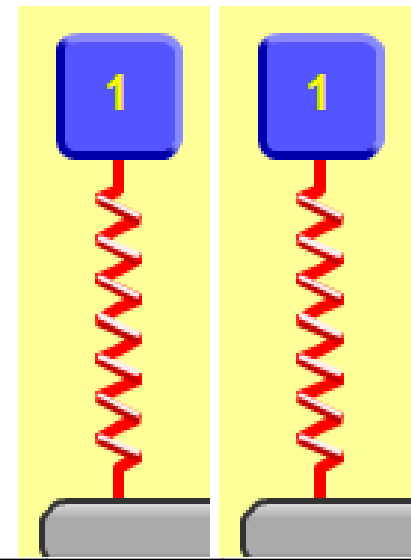

<b>Mass (kg)</b>	<b>3.0</b>	<b>3.0</b>
<b>Spring constant (N/m)</b>	<b>400</b>	<b>400</b>
<b>Driver Amplitude (cm)</b>	<b>0.5</b>	<b>1.5</b>



4. If the frequency  $f$  of the driver is not the same as the resonant frequency, which statement is most accurate?

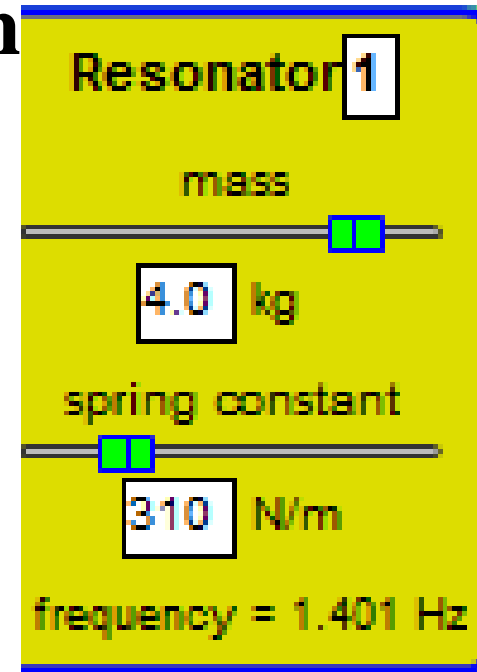
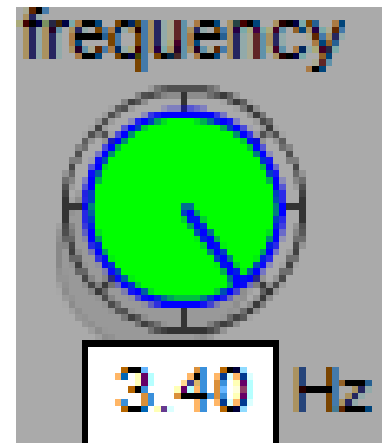
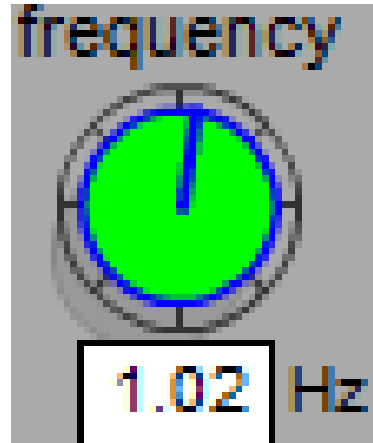
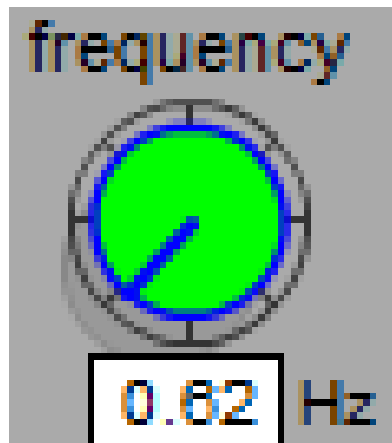

The steady-state amplitude is ..

- a) smallest at the highest driver  $f$ .
- b) largest at the highest driver  $f$ .
- c) is largest at driver  $f$  nearest the resonant frequency.
- d) is independent of driver  $f$ .

# *Under Pressure* (also Fluid Pressure Flow- Pressure tab)

by Trish Loeblein June 2012

## **Learning goals:**

**Students will be able to**

- 1. Investigate how pressure changes in air and water.**
- 2. Discover how you can change pressure.**
- 3. Predict pressure in a variety of situations**

**1. Order from lowest to highest pressure.**

**A.  $A < B < C$**

**B.  $C < B < A$**

**C. all are equal**

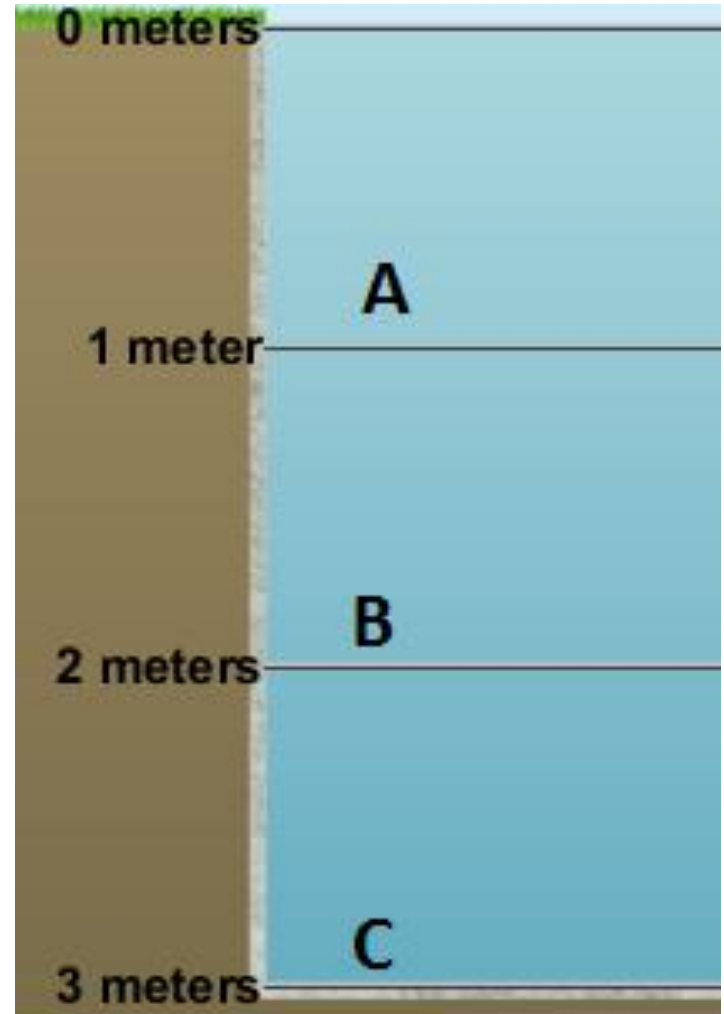

2. Look at the markers.  
Order from lowest to  
highest pressure.

- A.  $Y < Z < X$
- B.  $Y < X < Z$
- C.  $Z < X < Y$
- D.  $X < Z < Y$
- E. two are equal

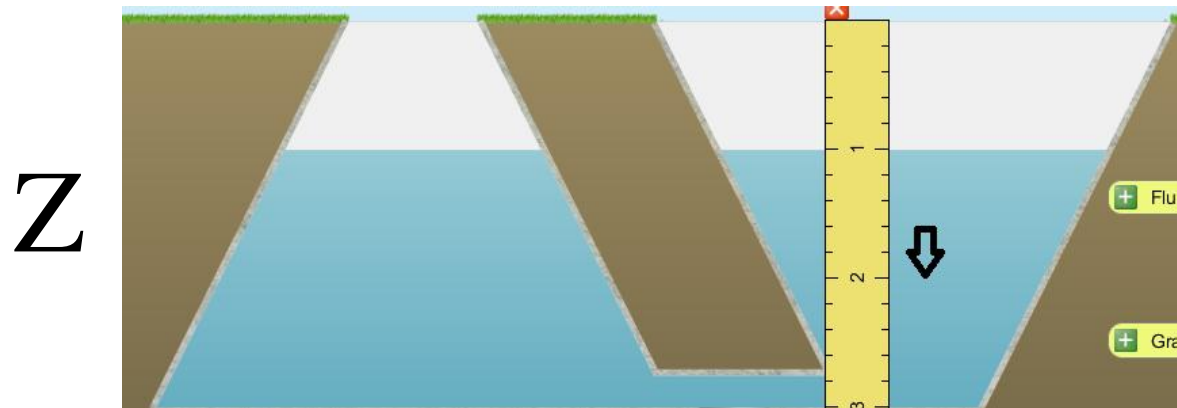
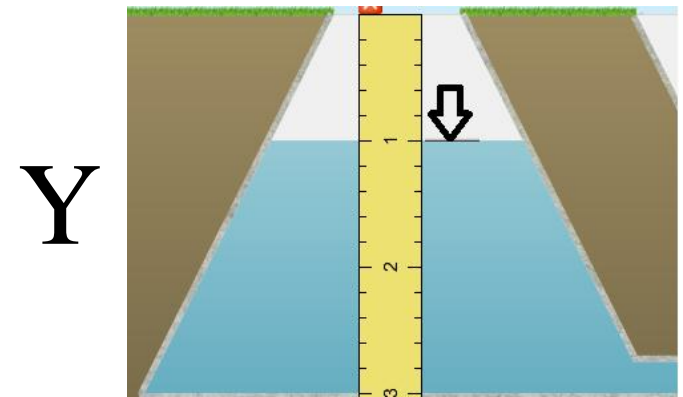
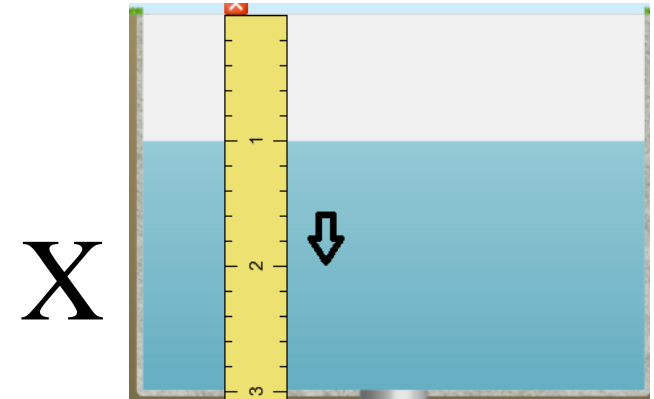

**3. What will happen to the pressure if more water is added?**

**A. increase**

**B. decrease**

**C. stay the same**

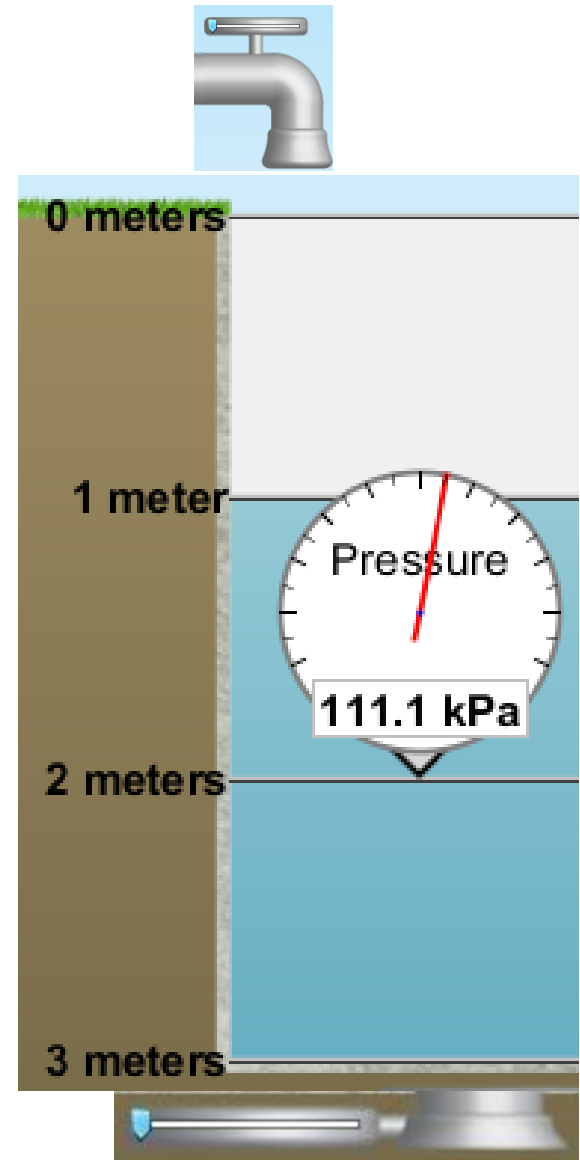

4. What will happen to the pressure if more water is added while the same amount is removed?

A. increase

B. decrease

C. stay the same

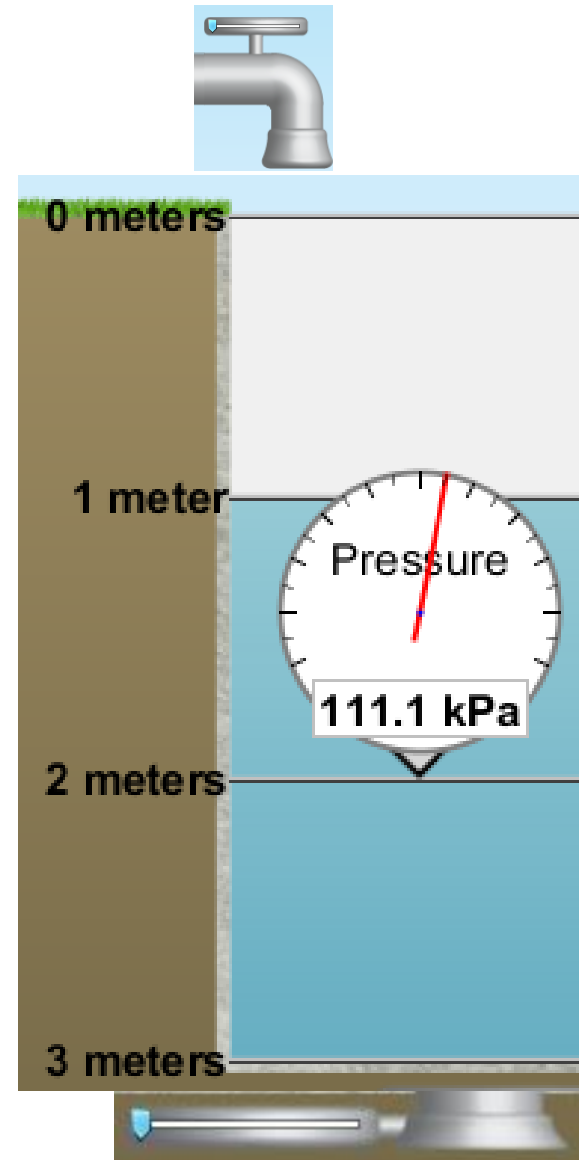

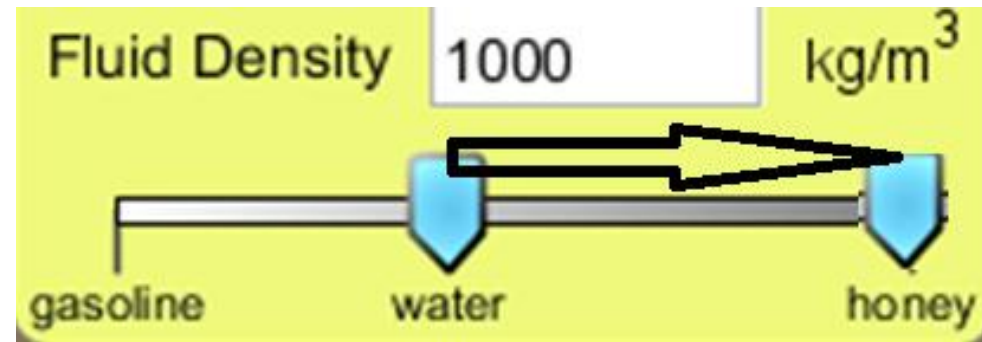

5. What will happen to the pressure if the fluid were changed to honey?

- A. increase
- B. decrease
- C. stay the same

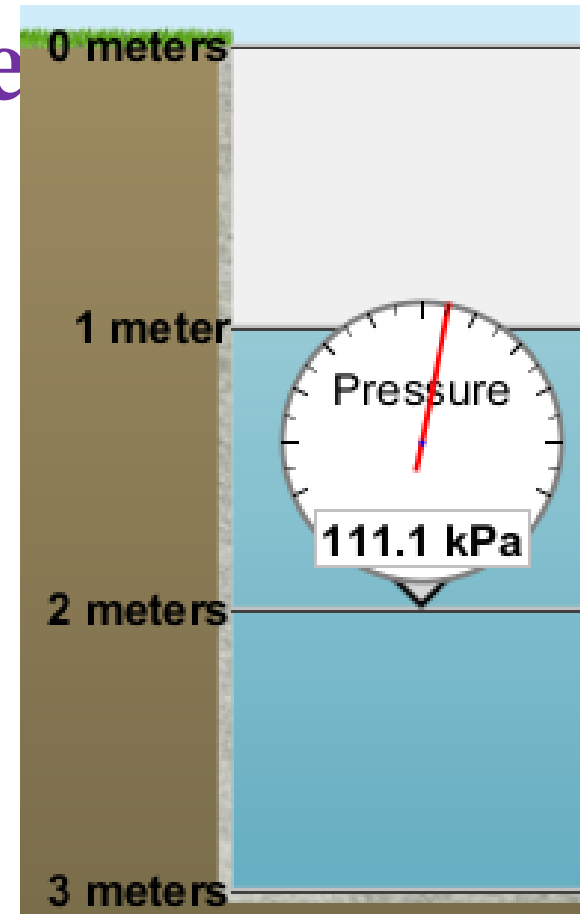

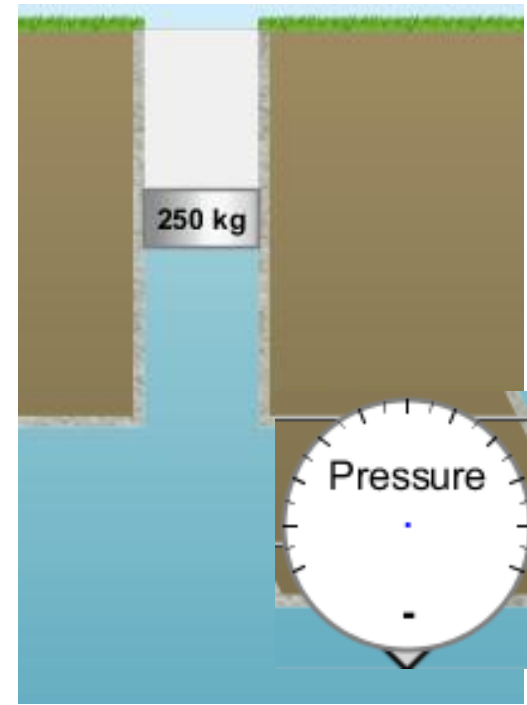
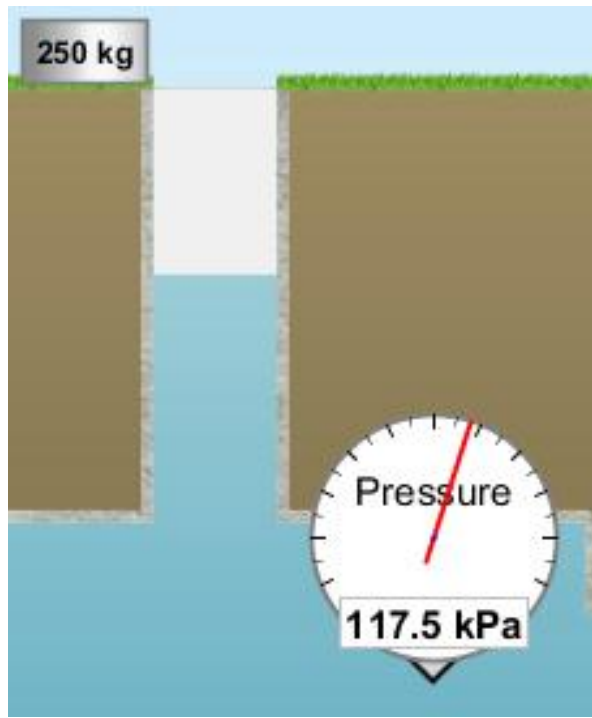

**6. If the 250 kg mass was put on the water column, what will happen to the pressure?**

- A. increase**
- B. decrease**
- C. stay the same**



**7. If the only change was to remove the air pressure, what will happen to the pressure?**

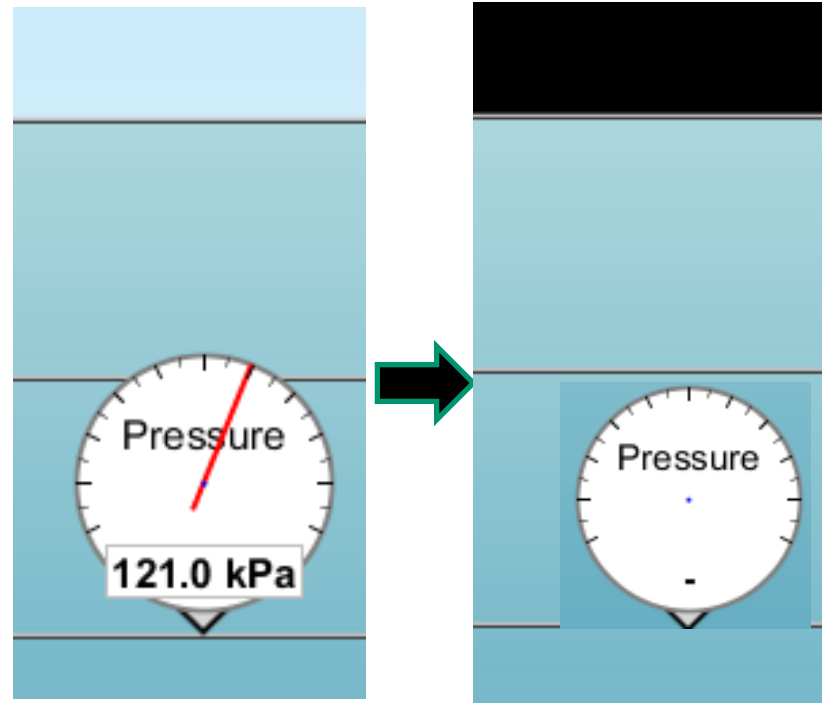

- A. increase by 101.3 kPa**
- B. decrease by 101.3 kPa**
- C. stay the same**
- D. Something else**

8. If the only change was to go to a place where the gravity was doubled, what will happen to the pressure?

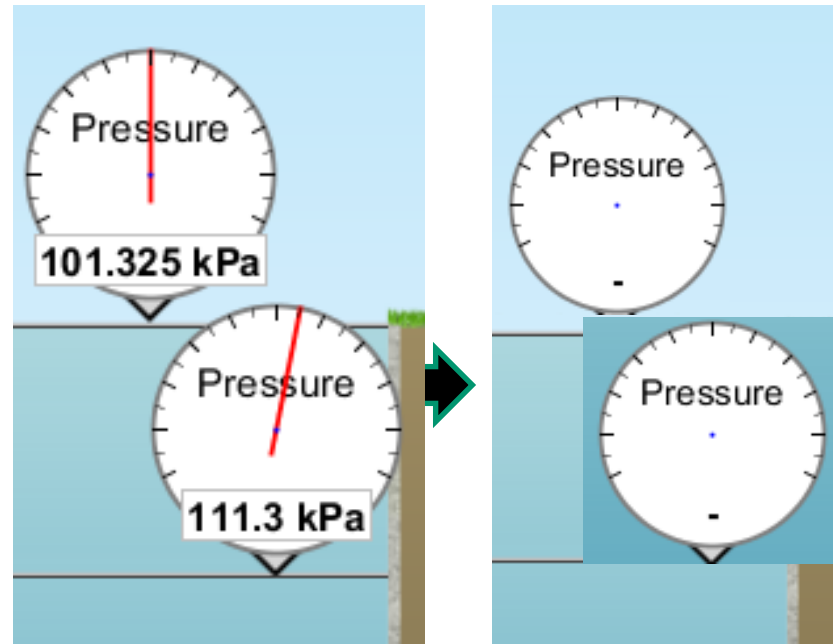

- A. Both pressures would double
- B. Only the air pressure would double
- C. The air pressure would double, and the water pressure would increase some
- D. Something else

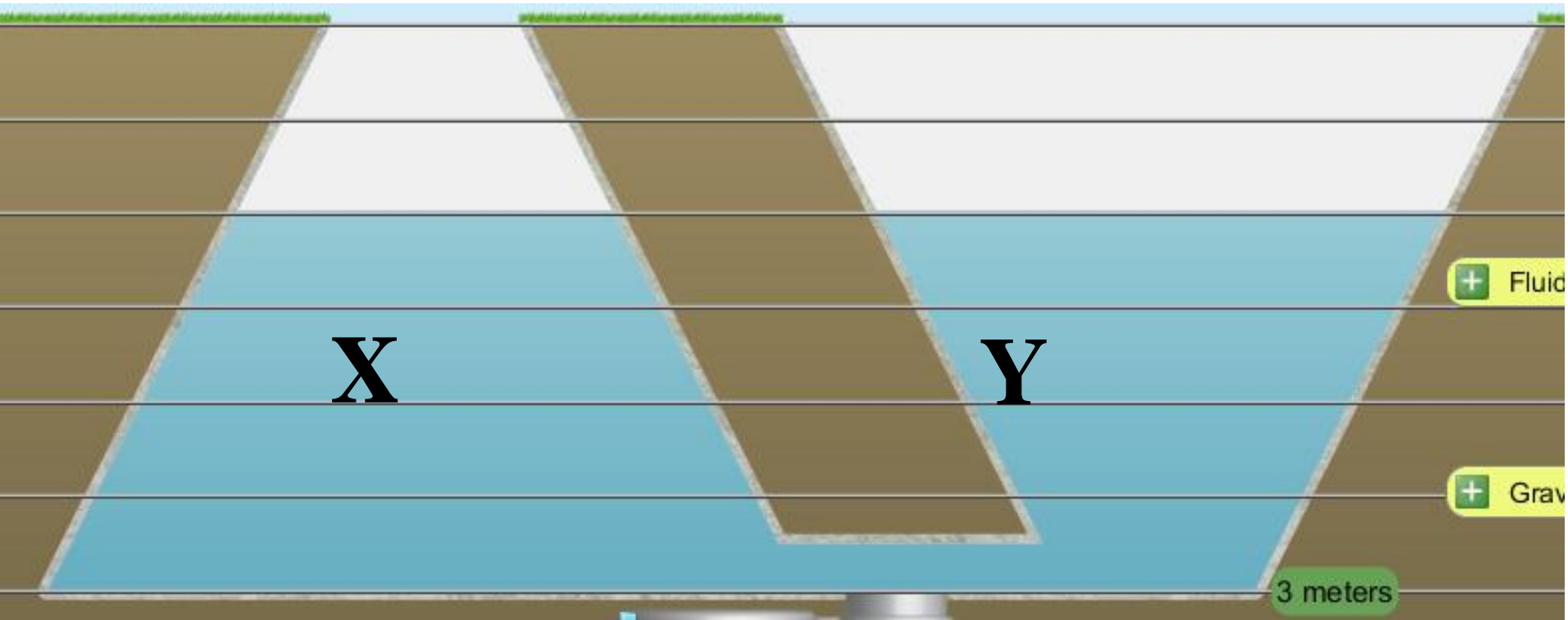

9. How do the pressures at the two locations compare?

- A.  $X > Y$
- B.  $Y > X$
- C. They are the same

# Density Concept Question

by Trish Loeblein

used with Density Activity

## **Learning Goals:**

Students will be able to use macroscopic evidence to:

- Measure the volume of an object by observing the amount of fluid it displaces or can displace.
- Provide evidence and reasoning for how objects of similar:
  - mass can have differing volume
  - volume can have differing mass.
- Identify the unknown materials by calculating density using displacement of fluid techniques and reference tables provided in the simulation.

**1. You put in a pool with 100 L of water. Then you drop an aluminum block in and the volume rises to 105 L. What is the volume of the block?**

**A. 5L**

**B. 105 L**

**C. Depends on block shape**

**D. Not enough information**

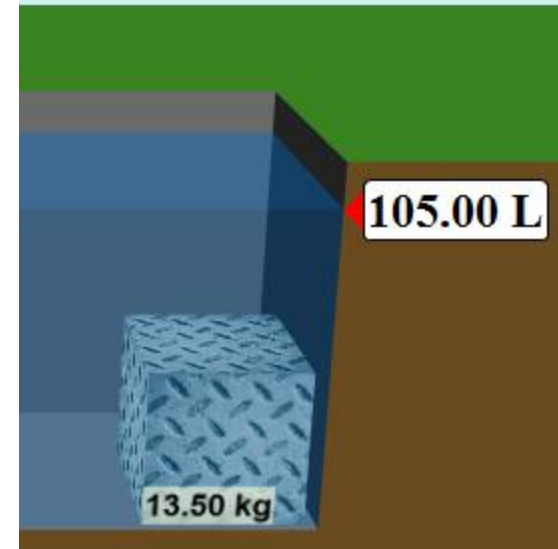
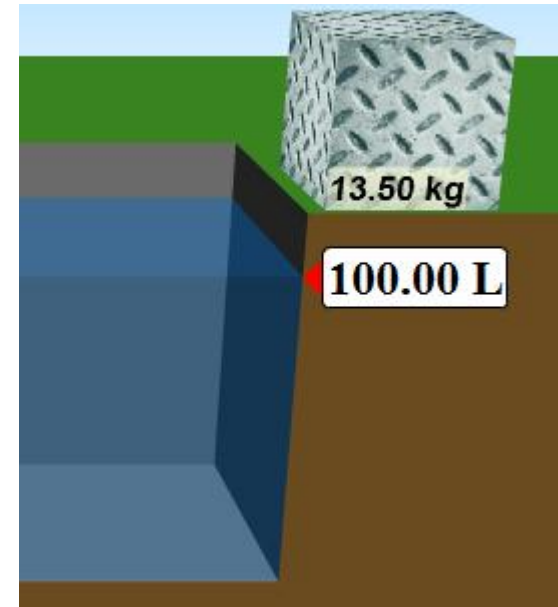

**2. You put in a pool with 100 L of water. Then you drop an wood block in and the volume rises to 102 L. What is the volume of the block?**

**A. 5L**

**B. 105 L**

**C. Depends on block shape**

**D. Not enough information**

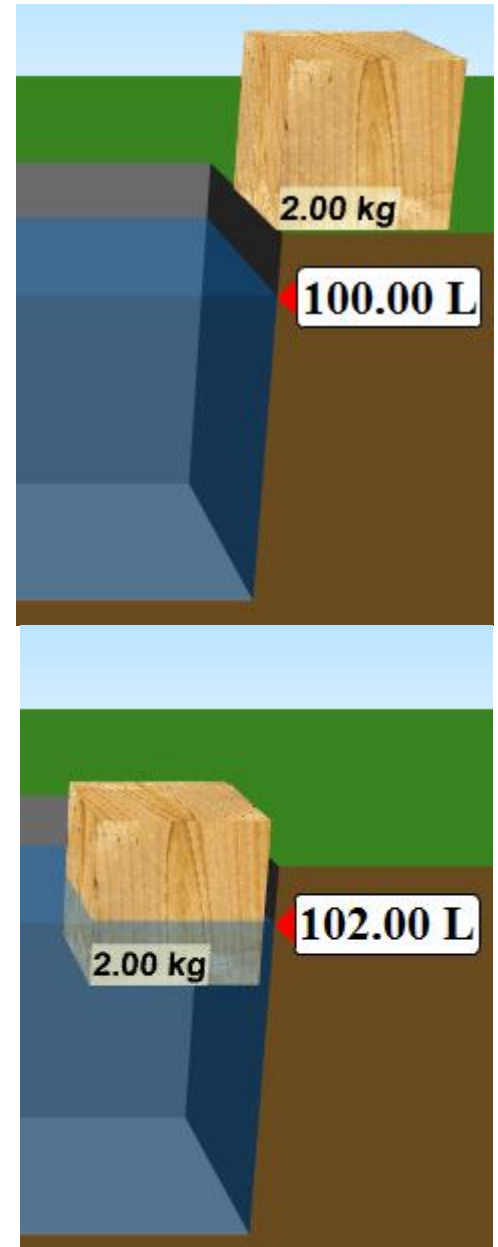

**3. Two different blocks, both with a mass of 5 kg have different volumes. How is it possible?**

- A. One is more dense**
- B. They are made of the same material**
- C. They are made of different material**
- D. More than one of these**
- E. None of the above**

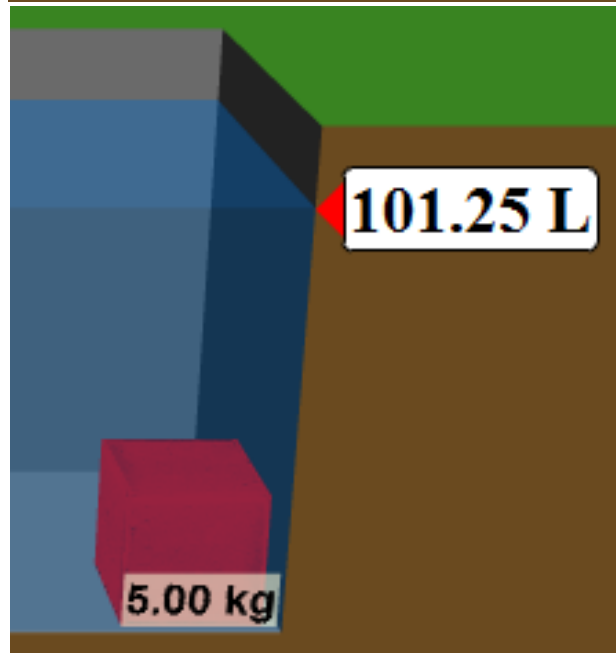

**4. Two different blocks, both with a volume of 3.38L have different mass. What would be a good explanation?**

**A. A is more dense**

**B. D is more dense**

**C. A sinks**

**D. D floats**

**E. More than one of these**

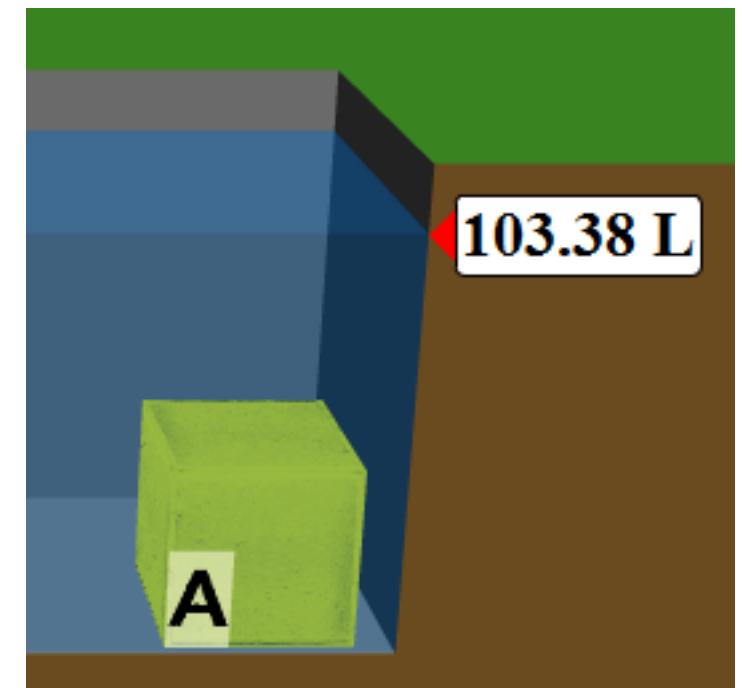
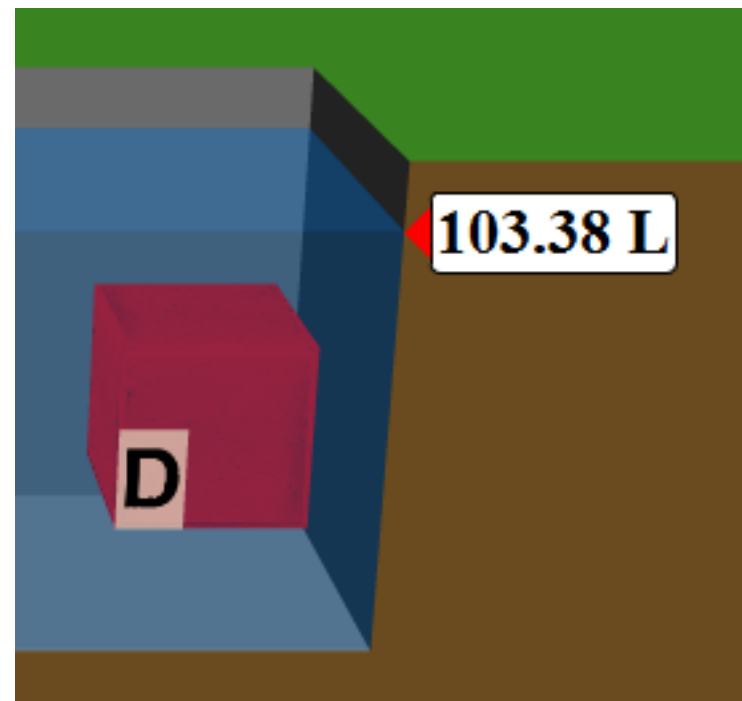



# Some information for 4

Volume  
changes when  
*submersed*

103.38 L

100.00 L

Mass found using scale

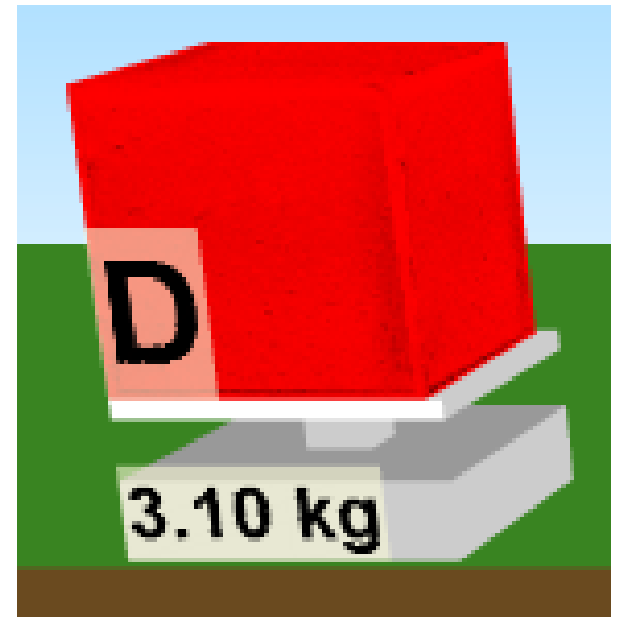

**It is true that D floats, but it is irrelevant to question. The important thing is that A is more dense – it's mass is greater even though volume is the same.**

**5. What is the density of the block?**

- A. 0.63 L/kg**
- B. 1.6 L/kg**
- C. 0.63 kg/L**
- D. 1.6 kg/L**

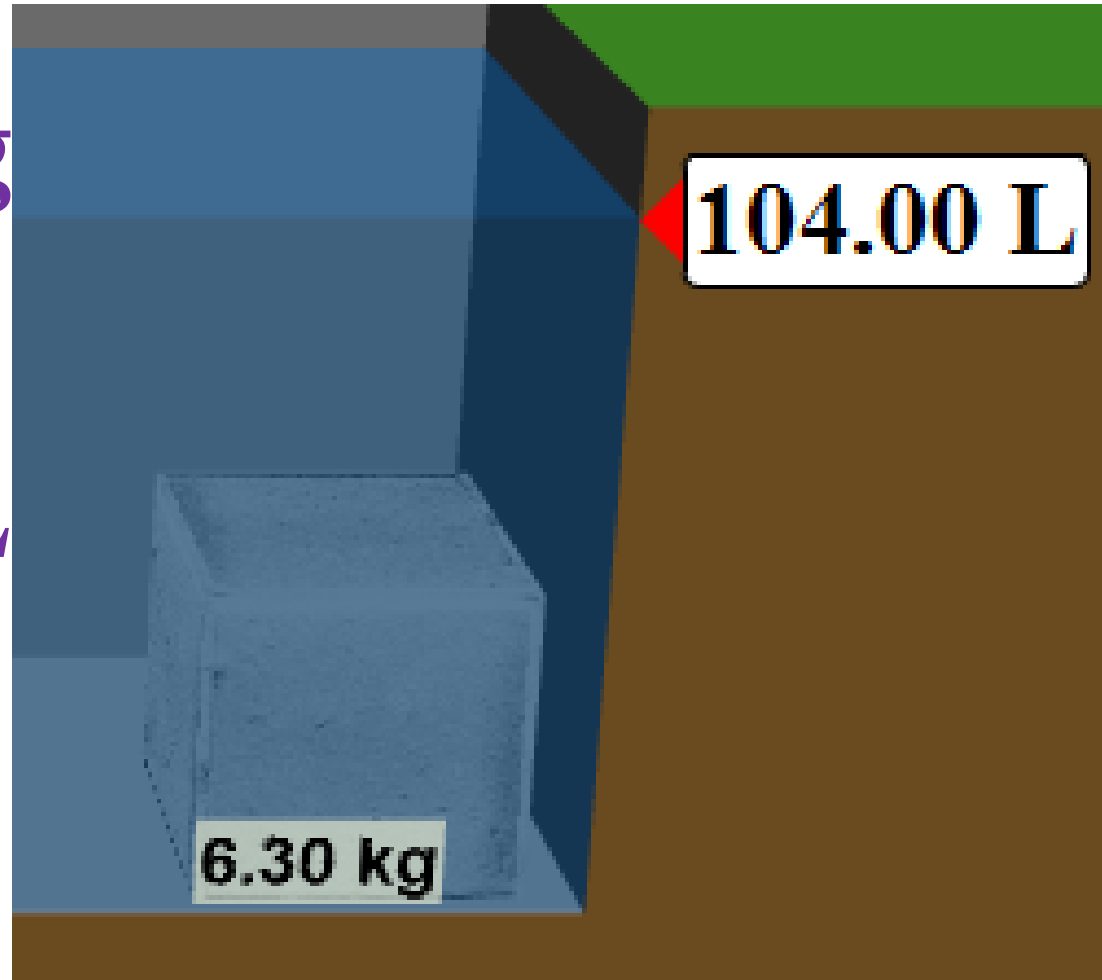

**6. Joe was doing a lab. He massed an object and then pushed it into some water. He recorded- 3.5 kg and 5 L. What might the object be?**

	<u>Material</u>	<u>Density (kg/L)</u>
<b>A.</b>	<b>Wood</b>	<b>0.40</b>
<b>B.</b>	<b>Apple</b>	<b>0.64</b>
<b>C.</b>	<b>Gasoline</b>	<b>0.70</b>
<b>D.</b>	<b>Diamond</b>	<b>3.53</b>
<b>E.</b>	<b>Lead</b>	<b>11.3</b>

**7. What is the mass of the block if it has a density of 0.86?**

- A. 5.0 kg**
- B. 91 kg**
- C. 0.15 kg**
- D. 6. kg**

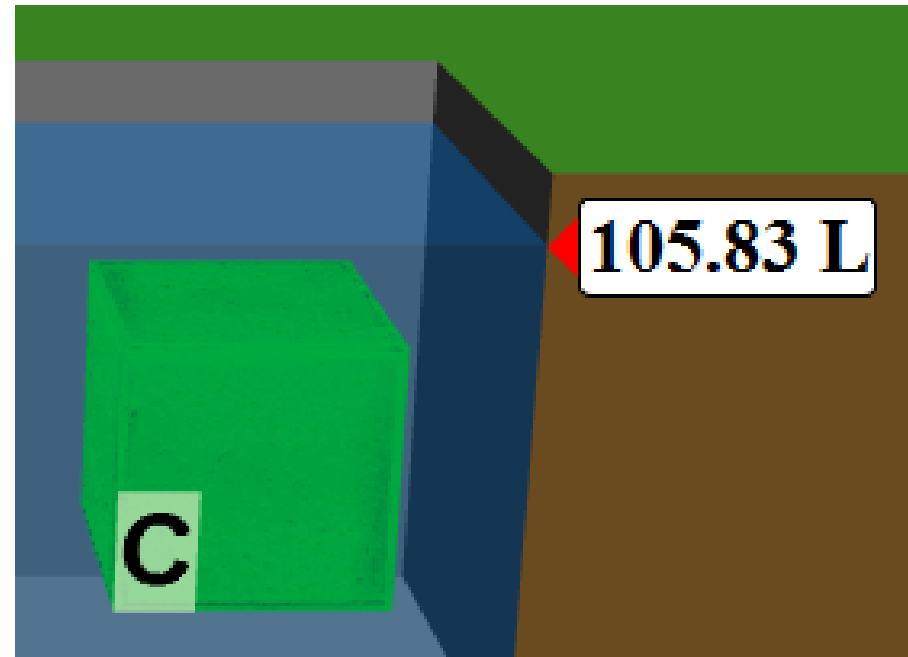

# Thanks to shared ideas from:

- Slides 11, 12, 14,15,16,34, 50, 75,76,79, 80,81,151,152, 155- 158,160-163,170 from Dubson or Dubson/Tanner
- Slide 77,78 Franklin/Beale
- Slides 52,53,54,55,111-121, 165-168, from Pollock
- Slides 124,125,126,136,145, 191-199 from Perkins (and maybe 23-29 &128-135)
- Slide 17 comes from Physics Bowl
- Slide56 Adapted from Department of Physics and Engineering Physics University of Saskatchewan
- Slides 51, 200, 201, PI Problems for the Physics Suite Edward F. Redish